



Program  
on  
Improved  
Seismic  
Safety  
Provisions

*Of the National Institute of Building Sciences*

**1997 Edition**

**NEHRP RECOMMENDED PROVISIONS  
FOR SEISMIC REGULATIONS  
FOR NEW BUILDINGS  
AND OTHER STRUCTURES**

**Part 2: Commentary (FEMA 303)**

The **Building Seismic Safety Council (BSSC)** was established in 1979 under the auspices of the National Institute of Building Sciences as an entirely new type of instrument for dealing with the complex regulatory, technical, social, and economic issues involved in developing and promulgating building earthquake hazard mitigation regulatory provisions that are national in scope. By bringing together in the BSSC all of the needed expertise and all relevant public and private interests, it was believed that issues related to the seismic safety of the built environment could be resolved and jurisdictional problems overcome through authoritative guidance and assistance backed by a broad consensus.

The BSSC is an independent, voluntary membership body representing a wide variety of building community interests. Its fundamental purpose is to enhance public safety by providing a national forum that fosters improved seismic safety provisions for use by the building community in the planning, design, construction, regulation, and utilization of buildings.

To fulfill its purpose, the BSSC: (1) promotes the development of seismic safety provisions suitable for use throughout the United States; (2) recommends, encourages, and promotes the adoption of appropriate seismic safety provisions in voluntary standards and model codes; (3) assesses progress in the implementation of such provisions by federal, state, and local regulatory and construction agencies; (4) identifies opportunities for improving seismic safety regulations and practices and encourages public and private organizations to effect such improvements; (5) promotes the development of training and educational courses and materials for use by design professionals, builders, building regulatory officials, elected officials, industry representatives, other members of the building community, and the public; (6) advises government bodies on their programs of research, development, and implementation; and (7) periodically reviews and evaluates research findings, practices, and experience and makes recommendations for incorporation into seismic design practices.

See Appendix E of the *Commentary* volume for a full description of BSSC activities.

#### **BOARD OF DIRECTION: 1997**

<b>Chairman</b>	Eugene Zeller, City of Long Beach, California
<b>Vice Chairman</b>	William W. Stewart, Stewart-Scholberg Architects, Clayton, Missouri (representing the American Institute of Architects)
<b>Secretary</b>	Mark B. Hogan, National Concrete Masonry Association, Herndon, Virginia
<b>Ex-Officio</b>	James E. Beavers, James E. Beavers Consultants, Oak Ridge, Tennessee
<b>Members</b>	Eugene Cole, Carmichael, California (representing the Structural Engineers Association of California); S. K. Ghosh, Portland Cement Association, Skokie, Illinois; Nestor Iwankiw, American Institute of Steel Construction, Chicago, Illinois; Gerald H. Jones, Kansas City, Missouri (representing the National Institute of Building Sciences); Joseph Nicoletti, URS/John A. Blume and Associates, San Francisco, California (representing the Earthquake Engineering Research Institute); Jack Prosek, Turner Construction Company, San Francisco, California (representing the Associated General Contractors of America); W. Lee Shoemaker, Metal Building Manufacturers Association, Cleveland, Ohio; John C. Theiss, Theiss Engineers, Inc., St. Louis, Missouri (representing the American Society of Civil Engineers); Charles Thornton, Thornton-Tomasetti Engineers, New York, New York (representing the Applied Technology Council); David P. Tyree, American Forest and Paper Association, Colorado Springs, Colorado; David Wismer, Department of Licenses and Inspections, Philadelphia, Pennsylvania (representing the Building Officials and Code Administrators International); Richard Wright, National Institute of Standards and Technology, Gaithersburg, Maryland (representing the Interagency Committee for Seismic Safety in Construction)
<b>BSSC Staff</b>	James R. Smith, Executive Director; Claret M. Heider, Technical Writer-Editor/Program Manager; Thomas Hollenbach, Deputy Executive; Lee Lawrence Anderson, Director, Special Projects; Mary Marshall, Administrative Assistant; Patricia Blasi, Administrative Assistant

*BSSC Program on Improved Seismic Safety Provisions*

# **NEHRP RECOMMENDED PROVISIONS**

**(National Earthquake Hazards Reduction Program)**

## **FOR SEISMIC REGULATIONS**

### **FOR NEW BUILDINGS AND**

### **OTHER STRUCTURES**

**1997 EDITION**

**Part 2: COMMENTARY  
(FEMA 303)**

**Prepared by the  
Building Seismic Safety Council  
for the  
Federal Emergency Management Agency**

**BUILDING SEISMIC SAFETY COUNCIL  
Washington, D.C.  
1997**

NOTICE: Any opinions, findings, conclusions, or recommendations expressed in this publication do not necessarily reflect the views of the Federal Emergency Management Agency. Additionally, neither FEMA nor any of its employees make any warranty, expressed or implied, nor assume any legal liability or responsibility for the accuracy, completeness, or usefulness of any information, product, or process included in this publication.

This report was prepared under Contract EMW-C-4536 between the Federal Emergency Management Agency and the National Institute of Building Sciences.

Building Seismic Safety Council activities and products are described at the end of this report. For further information, contact the Building Seismic Safety Council, 1090 Vermont, Avenue, N.W., Suite 700, Washington, D.C. 20005; phone 202-289-7800; fax 202-289-1092; e-mail [bssc@nibs.org](mailto:bssc@nibs.org). Copies of this report may be obtained by contacting the FEMA Publication Distribution Facility at 1-800-480-2520.

# CONTENTS

## *NEHRP RECOMMENDED PROVISIONS FOR SEISMIC REGULATIONS FOR NEW BUILDINGS AND OTHER STRUCTURES*

### 1997 EDITION

#### PART 2: COMMENTARY

<b>Chapter 1 Commentary, General Provisions</b> .....	<b>1</b>
1.1 Purpose .....	2
1.3 Seismic Use Groups and Factors .....	4
<b>Chapter 2 Commentary, Glossary and Notations</b> .....	<b>11</b>
<b>Chapter 3 Commentary, Quality Assurance</b> .....	<b>33</b>
3.1 Scope .....	33
3.2 Quality Assurance Plan .....	34
3.3 Special Inspections .....	35
3.4 Testing: .....	36
3.5 Structural Observations .....	36
3.6 Reporting and Compliance Procedures: .....	36
<b>Chapter 4 Commentary, Ground Motion</b> .....	<b>37</b>
4.1 Determining Maximum Considered Earthquake and Design Earthquake Ground Motion Accelerations and Response Spectra .....	37
4.2 Seismic Design Category .....	52
<b>Chapter 5 Commentary, Structural Design Criteria</b> .....	<b>59</b>
5.2 Design Basis .....	59
5.3 Equivalent Lateral Force Procedure .....	91
5.4 Modal Analysis Procedure .....	103
5.5 Soil-structure Interaction Effects .....	107
<b>Chapter 6 Commentary, Architectural, Mechanical, and Electrical Components</b>	
Design Requirements .....	131
6.1 General .....	131

6.2 Architectural Component Design .....	139
6.3 Mechanical and Electrical Component Design .....	144
Related Concerns .....	151
<b>Chapter 7 Commentary, Foundation Design Requirements .....</b>	<b>153</b>
7.1 General .....	153
7.2 Strength of Components and Foundations .....	153
7.3 Seismic Design Categories A and B .....	153
7.4 Seismic Design Category C .....	153
7.5 Seismic Design Categories D, E, and F .....	169
<b>Chapter 8 Commentary, Steel Structure Design Requirements .....</b>	<b>177</b>
8.1 Reference Documents .....	177
8.2 Seismic Requirements for Steel Structures .....	177
8.3 Seismic Design Categories A, B, and C .....	177
8.4 Seismic Design Categories D, E, and F .....	177
8.5 Cold-formed Steel Seismic Requirements .....	177
8.6 Light-framed Walls .....	177
8.7 Seismic Requirements for Steel Deck Diaphragms .....	178
8.5 Steel Cables .....	178
<b>Chapter 9 Commentary, Concrete Structure Design Requirements .....</b>	<b>179</b>
9.1 Reference Document .....	179
9.2 Bolts and Headed Stud Anchors in Concrete .....	184
9.3 Classification of Moment Frames .....	186
9.4 Seismic Design Category A .....	186
9.5 Seismic Design Category B .....	186
9.6 Seismic Design Category C .....	186
9.7 Seismic Design Categories D, E, and F .....	186
Appendix to Chapter 9, Reinforced Concrete Structural Systems Composed of Interconnected Precast Elements .....	191
<b>Chapter 10 Commentary, Composite Steel and Concrete Structure Design Requirements .....</b>	<b>197</b>
<b>Chapter 11 Commentary, Masonry Structure Design Requirements .....</b>	<b>199</b>
11.1 General .....	199
11.2 Construction Requirements .....	199
11.3 General Design Requirements .....	200
11.5 Strength and Deformation Requirements .....	202
11.6 Flexure and Axial Loads .....	204

11.8 Special Requirements for Beams .....	210
11.9 Special Requirements for Columns .....	211
11.10 Special Requirements for Walls .....	212
11.11 Special Requirements for Shear Walls .....	212
Appendix to Chapter 11 Commentary, Alternative Masonry Structure Design Requirements .....	221
<b>Chapter 12 Commentary, Wood Structure Design Requirements .....</b>	<b>223</b>
12.1 Reference Documents .....	223
12.2 Design Methods .....	224
12.3 Engineered Wood Construction .....	225
12.4 Diaphragms and Shear Walls .....	231
12.5 Conventional Light-frame Construction .....	237
12.6 Seismic Design Category A .....	256
12.7 Seismic Design Categories B, C, and D .....	256
12.8 Seismic Design Categories E and F .....	256
<b>Chapter 13 Commentary, Seismically Isolated Structures .....</b>	<b>259</b>
13.1 General .....	261
13.2 Criteria Selection .....	262
13.3 Equivalent-lateral-force Design Procedure .....	264
13.4 Dynamic Lateral Response Procedure: .....	267
13.5 Nonstructural Components .....	268
13.6 Detailed System Requirements .....	268
13.8 Design and Construction Review .....	269
13.9 Required Tests of the Isolation System .....	269
<b>Chapter 14 Commentary, Nonbuilding Structure Design Requirements .....</b>	<b>273</b>
14.1 General .....	273
14.2 Structural Design Requirements .....	274
14.3 Nonbuilding Structures Similar to Buildings .....	277
14.4 Nonbuilding Structures Not Similar to Buildings .....	277
Appendix to Chapter 14 .....	277
<b>Commentary Appendix A, Development of Maximum Considered Earthquake Ground Motion Maps 1 Through 24 .....</b>	<b>287</b>
<b>Commentary Appendix B, Development of the USGS Seismic Maps .....</b>	<b>303</b>
The Council: Its Purpose and Activities .....	343

## Chapter 1 Commentary

### GENERAL PROVISIONS

Chapter 1 sets forth general requirements for applying the analysis and design provisions contained in Chapters 2 through 14 of the *NEHRP Recommended Provisions for Seismic Regulations for New Buildings and Other Structures*. It is similar to what might be incorporated in a code as administrative regulations.

Chapter 1 is designed to be as compatible as possible with normal code administrative provisions (especially as exemplified by the three national model codes), but it is written as the guide to use of the rest of the document, not as a regulatory mechanism. The word "shall" is used in the *Provisions*, not as a legal imperative, but simply as the language necessary to ensure fulfillment of all the steps necessary to technically meet a minimum standard of performance.

It is important to note that the *NEHRP Recommended Provisions* is intended to serve as a **source** document for use by any interested member of the building community. Thus, some users may alter certain information within the *Provisions* (e.g., the determination of which use groups are included within the higher Seismic Use Groups might depend on whether the user concluded that the generally more-demanding design requirements were necessary). It is strongly emphasized, however, that such "tailoring" should be carefully considered by highly qualified individuals who are fully aware of all the implications of any changes on all affected procedures in the analysis and design sequences of the document.

Further, although the *NEHRP Recommended Provisions* is national in scope, it presents minimum criteria. It is neither intended to nor does it justify any reduction in higher standards that have been locally established, particularly in areas of highest seismicity.

Reference is made throughout the document to decisions and actions that are delegated to an unspecified "authority having jurisdiction." The document is intended to be applicable to many different types of jurisdictions and chains of authority, and an attempt has been made to recognize situations where more than technical decision-making can be presumed. In fact, the document anticipates the need to establish standards and approval systems to accommodate the use of the document for development of a regulatory system. A good example of this is in Sec. 1.2.6, "Alternate Materials and Alternate Means and Methods of Construction," where the need for well-established criteria and systems of testing and approval are recognized even though few such systems are in place. In some instances, the decision-making mechanism referred to is clearly most logically the province of a building official or department; in others, may be a law-making body such as a state legislature, a city council, or some other state or local policy-making body. The term "authority having jurisdiction" has been used to apply to all of these entities. A good example of the need for keeping such generality in mind is provided by the California law concerning the design and construction of schools. That law establishes requirements for independent special inspection approved and supervised by the Office of the State Architect, a state-level office that does not exist in many other states.



Note that Appendix A to the *Commentary* volume presents a detailed explanation of the development of *Provisions* Maps 1 through 24 and Appendix B describes development of the U.S. Geological Survey seismic hazard maps on which the *Provisions* maps are based. An overview of the Building Seismic Safety Council (BSSC) and its activities appears at the end of the volume.

**1.1 PURPOSE:** The goal of the *NEHRP Recommended Provisions* is to present criteria for the design and construction of new structures subject to earthquake ground motions in order to minimize the hazard to life for all structures, to increase the expected performance of structures having a substantial public hazard due to occupancy or use as compared to ordinary structures, and to improve the capability of essential facilities to function after an earthquake. To this end, the *Provisions* provides the minimum criteria considered prudent for the protection of life safety in structures subject to earthquakes. The *Provisions* document has been reviewed extensively and balloted by the architectural, engineering, and construction communities and, therefore, it is a proper source for the development of building codes in areas of seismic exposure.

Some design standards go farther than these provisions and attempt to minimize damage as well as protect building occupants. For example, the *California Building Code* has added property protection in relation to the design and construction of hospitals and public schools. The *NEHRP Recommended Provisions* document generally considers property damage as it relates to occupant safety for ordinary structures. For high occupancy and essential facilities, damage limitation criteria are more strict in order to better provide for the safety of occupants and the continued functioning of the facility.

Some structural and nonstructural damage can be expected as a result of the "design ground motions" because the *Provisions* allow inelastic energy dissipation in the structural system. For ground motions in excess of the design levels, the intent of the *Provisions* is for the structure to have a low likelihood of collapse.

It must be emphasized that absolute safety and no damage even in an earthquake event with a reasonable probability of occurrence cannot be achieved for most structures. However, a high degree of life safety, albeit with some structural and nonstructural damage, can be economically achieved in structures by allowing inelastic energy dissipation in the structure. The objective of the *Provisions* therefore is to set forth the minimum requirements to provide reasonable and prudent life safety. For most structures designed and constructed according to the *Provisions*, it is expected that structural damage from even a major earthquake would likely be repairable, but the damage may not be economically repairable.

Where damage control is desired, the design must provide not only sufficient strength to resist the specified seismic loads but also the proper stiffness to limit the lateral deflection. Damage to nonstructural elements may be minimized by proper limitation of deformations; by careful attention to detail; and by providing proper clearances for exterior cladding, glazing, partitions, and wall panels. The nonstructural elements can be separated or floated free and allowed to move independently of the structure. If these elements are tied rigidly to the structure, they should be protected from deformations that can cause cracking; otherwise, one must expect such damage. It should be recognized, however, that major earthquake ground motions can cause deformations much larger than the specified drift limits in the *Provisions*.

---

Where prescribed wind loading governs the stress or drift design, the resisting system still must conform to the special requirements for seismic force resisting systems. This is required in order to resist, in a ductile manner, potential seismic loadings in excess of the prescribed loads.

A proper continuous load path is an obvious design requirement for equilibrium, but experience has shown that it often is overlooked and that significant damage and collapse can result. The basis for this design requirement is twofold:

1. To ensure that the design has fully identified the seismic force resisting system and its appropriate design level and
2. To ensure that the design basis is fully identified for the purpose of future modifications or changes in the structure.

Detailed requirements for selecting or identifying and designing this load path are given in the appropriate design and materials chapters.

**1.2.1 Scope:** The scope statement establishes in general terms the applicability of the *Provisions* as a base of reference. Certain structures are exempt and need not comply:

1. Detached one- and two-family dwellings located where  $S_{DS}$  is less than 0.4g also are exempt because they represent exceptionally low risks (see Sec. 1.2).
2. A simple procedure is specified for detached one- and two-story wood frame dwellings in regions of higher seismicity. Although some control is necessary to ensure the integrity of such structures, it is felt that the requirements of Sec. 12.5 are adequate to provide the safety required based on the history of such frame construction--especially low structures--in earthquakes.
3. Agricultural storage structures are generally exempt from most code requirements because of the exceptionally low risk to life involved and that is the case of the *Provisions*.

Existing structures, except for additions thereto and changes of occupancy therein, are not within the scope of the *Provisions*. FEMA, however, currently is sponsoring a program on mitigation of the seismic hazard to existing buildings; for information, write FEMA, Earthquake Programs, Washington, D.C. 20472.

The *Provisions* are not written to prevent damage due to earth slides (such as those that occurred in Anchorage, Alaska), to liquefaction (such as occurred in Niigata, Japan), or to tsunami (such as occurred in Hilo, Hawaii). It provides for only minimum required resistance to earthquake ground-shaking, without settlement, slides, subsidence, or faulting in the immediate vicinity of the structure.

The *Provisions* are not retroactive and apply only to existing structures when there is an addition, change of use, or alteration.

**1.2.3 Additions:** Additions that are structurally independent of an existing structure are considered to be new structures required to conform with the *Provisions*. For additions that are not structurally independent, the intent is that the addition as well as the existing structure be made to comply with the *Provisions* except that an increase of up to 5 percent of the mass

contributing to seismic forces is permitted in any elements of the existing structure without bringing the entire structure into conformance with the *Provisions*.

**1.2.4 Change of Use:** It is strongly recommended that changes to an existing structure:

1. Should not reduce the lateral force resistance of the structure,
2. Should provide for the seismic forces required by the *Provisions*, or
3. Should comply with legally adopted provisions regulating the repair and rehabilitation of existing structures as related to earthquake resistance.

When a change in use results in a change to a higher Seismic Use Group, the structure must be made to conform to the *Provisions* for the new Seismic Use Group.

**1.2.6 Alternate Materials and Alternate Means and Methods of Construction:** It is not possible for a design standard to provide criteria for the use of all possible materials and their combinations and methods of construction either existing or anticipated. While not citing specific materials or methods of construction currently available that require approval, this section serves to emphasize the fact that the evaluation and approval of alternate materials and methods require a recognized and accepted approval system. The requirements for materials and methods of construction contained within the document represent the judgment of the best use of the materials and methods based on well-established expertise. It is important that any replacement or substitute be evaluated with an understanding of all the ramifications of performance, strength, and durability implied by the *Provisions*.

It also is recognized that until needed approval standards and agencies are created, authorities having jurisdiction will have to operate on the basis of the best evidence available to substantiate any application for alternates. If accepted standards are lacking, it is strongly recommended that applications be supported by extensive reliable data obtained from tests simulating, as closely as is practically feasible, the actual load and/or deformation conditions to which the material is expected to be subjected during the service life of the structure. These conditions, where applicable, should include several cycles of full reversals of loads and deformations in the inelastic range.

**1.3 SEISMIC USE GROUPS AND FACTORS:** The expected performance of buildings under the various earthquakes that can affect them are controlled by assignment of each building to one of three Seismic Use Groups. These Seismic Use Groups are categorized based on the occupancy of the buildings within the group and the relative consequences of severe earthquake induced damage to these buildings. The *Provisions* specify progressively more conservative strength, drift control, system selection and detailing requirements for buildings contained in the three groups, in order to attain minimum levels of earthquake performance suitable to the individual occupancies.

In previous editions of the *Provisions*, this categorization of structures, by occupancy, or use, was termed a Seismic Hazard Exposure Group. The name Seismic Use Group was adopted in the 1997 *Provisions* as being more representative of what this classification is. Seismic hazard relates to the severity and frequency of ground motion expected to affect a building. Since buildings contained in these groups are spread across the various zones of seismicity, from high to low hazard, the groups do not really relate to hazard. Rather, the groups are used to establish design

criteria, intended to produce specific types of performance in design earthquake events, based on the importance of preventing the building from experiencing excessive damage, due to its occupancy.

Historically, building code occupancy classifications have been based primarily on fire-safety considerations. It was concluded, however, that these traditional classifications would at least in part reflect some considerations contrary to good seismic design. Thus, it was decided that a new approach was needed for defining occupancy exposure to seismic hazards based on a commonality of conditions proposed for the use of a building facility or space. These conditions involve evaluation of parameters consisting of, but not limited to the number, age, and condition of the persons normally expected to be within or without the immediate environs of the building; the size, height, and area of the building; the spacing of the building relative to public rights-of-way over which the designer has no control relative to the future number of persons exposed to risk by the buildings; and the varying degree of built-in or brought-in hazards based on possible use of the building. Accordingly, early in the development of the preliminary version of the *Provisions* occupancy types were regrouped and expanded to cover the range of factors critical to seismic safety in terms of life loss. The expanded classification types were derived from the 1973 *Uniform Building Code (UBC)*.

In terms of post-earthquake recovery and redevelopment, certain types of occupancies are vital to public needs, and these special occupancies were identified and given specific recognition (i.e., in terms of disaster preparedness, fire and police stations, hospitals, and regional communication centers identified as critical emergency services should not be included in the same classification as retail stores, office buildings, and factories as is presently the case in some codes).

Because of vital public needs immediately following a natural disaster, attention also was given to the preservation of strategic contents in distinct building types (e.g., storage facilities for medical supplies, critical foodstuffs, and other emergency materials). It was noted that disaster recovery officials initially considered the identification and protection of critical stocks needed during or immediately following an earthquake to be of paramount importance. This was not to imply, however, that all warehouses and storage facilities must be designed for the ultimate protection of any or all contents. What was indicated was that warehouse facilities should be designed on the basis of their maximum level of intended function or, to state it another way, medical supply warehouses being designed under higher standards may house anything while storage facilities of lesser ratings may not store critical supplies unless brought up to a higher level of seismic performance. Subsequent discussions with disaster recovery officials revealed that emergency contingency plans contemplated bringing needed medical and other recovery items including foodstuffs into a disaster area from outside staging areas and, therefore, no separate category of warehousing was required for the storage of critical materials. Thus, nine occupancy groups, A through I, were identified with some individual occupancies and groups bearing little or no relationship to current code groupings.

The occupancies then were consolidated into five basic groups by making a few compromises. This consolidation was done in an effort to place those occupancies initially identified into groups that shared common component performance criteria. The consolidation indicated that these groups were easily identifiable by use patterns, confirmation of the original occupancy-component-performance criteria rating. The intermediate grouping involved the following: Group

I--fire, police, hospitals; Group II--public assembly, open air stands, day care, schools, colleges, retail stores, shopping centers, offices, hotels, apartments, emergency vehicles, power utilities; Group III--restrained occupants, nurseries (nonambulatory); Group IV--aircraft hangers, woodworking, factories, repair garages, service stations, storage garages, wholesale, general warehouse, printing plants, factories, ice plants, dwellings, hazardous flammable storage, less hazardous flammable storage; and Group V--private garages, sheds, barns.

The occupancy grouping used in the 1985 Edition of the *Provisions* resulted from a logical consolidation of the grouping, consideration of code enforcement problems, and the need to use a common hazard exposure grouping for all of the design requirements. The grouping and definitions were modified in the 1988 Edition with further modifications in the 1997 *Provisions*. It is felt that this grouping can be augmented as local conditions warrant.

Specific consideration is given to Group III, essential facilities required for post-earthquake recovery. Also included are structures housing substances deemed to be hazardous to the public if they are released. Added in the 1991 Edition was a flag to urge consideration of the need for utility services after an earthquake. It is at the discretion of the authority having jurisdiction which structures are required for post-earthquake response and recovery. This is emphasized with the term “designated” before many of the structures listed in Sec. 1.3.1. Using Item 3, “designated medical facilities having emergency treatment facilities” as an example, the authority having jurisdiction should inventory medical facilities having emergency treatment facilities within the jurisdiction and designate those to be required for post-earthquake response and recovery. In a rural location where there may not be a major hospital, the authority having jurisdiction may choose to require outpatient surgery clinics to be designated Group III structures. On the other hand, these same clinics in a major jurisdiction with hospitals nearby probably would not be designated Group III structures.

Group II structures are those having a large number of occupants and those where the occupants’ ability to exit is restrained. The potential density of public assembly uses in terms of number of people warrant an extra level of care. The level of protection warranted for schools, day care centers, and medical facilities is greater than the level of protection warranted for occupancies where individuals are relatively self-sufficient in responding to an emergency.

Group I contains all uses other than those excepted generally from the requirements in Sec. 1.2. Those in Group I have lesser life hazard only insofar as there is the probability of lesser numbers of occupants in the buildings and the buildings are lower and/or smaller.

In buildings with multiple uses, the 1988 Edition of the *Provisions* required that the building be assigned the classification of the highest group occupying 15 percent or more of the total building area. This was changed in the 1991 Edition to require the building to be assigned to the highest group present. These requirements were further modified to allow different portions of a structure to be assigned different Seismic Use Group provided the higher group is not negatively impacted by the lower group. When a lower group impacts a higher group, the higher group must either be seismically independent of the other or the two must be in one structure designed seismically to the standards of the higher group. Care must be taken, however, for the case in which the two uses are seismically independent but are functionally dependent. The fire and life-safety requirements relating to exiting, occupancy, fire-resistive construction and the like of the

---

higher group must not be reduced by interconnection to the lower group. Conversely, one must also be aware that there are instances, although uncommon, where certain fire and life-safety requirements for a lower group may be more restrictive than those for the higher group. Such assignments also must be considered when changes are made in the use of a building even though existing buildings are not within the scope of the *Provisions*.

Consideration has been given to reducing the number of groupings by combining Groups I and II and leaving Group III the same as is stated above; however, the consensus of those involved in the *Provisions* development and update efforts to date is that such a merging would not be responsive to the relative performance desired of structures in these individual groups.

Although the *Provisions* explicitly require design for only a single level of ground motion, it is expected that buildings designed and constructed in accordance with these requirements will generally be able to meet a number of performance criteria, when subjected to earthquake ground motions of differing severity. The performance criteria discussed here were jointly developed during the BSSC Guidelines and Commentary for Seismic Rehabilitation of Buildings Project (ATC, 1995) and the Structural Engineers Association of California *Vision 2000* Project (SEAOC, 1995). In the system established by these projects, building earthquake performance is defined in terms of several standardized performance levels and reference ground motion levels. Each performance level is defined by a limiting state in which specified levels of degradation and damage have occurred to the structural and nonstructural building components. The ground motion levels are defined in terms of their probability of exceedance.

Four performance levels are commonly described as meaningful for the design of buildings. Although other terminology has been used in some documents, these may respectively be termed the operational, immediate occupancy, life safe, and collapse prevention levels. Of these, the operational level represents the least level of damage to the structure. Structures meeting this level when responding to an earthquake will experience only negligible damage to their structural systems and minor damage to nonstructural systems. The building will retain nearly all of its pre-earthquake strength and stiffness and all mechanical, electrical, plumbing, and other systems necessary for the normal operation of the building will be functional. If repairs are required, these can be conducted at the convenience of the occupants. The risk to life safety during an earthquake in a building meeting this performance level is negligible. Note, that in order for a building to meet this level, all utilities required for normal operation must be available, either through standard public service or emergency sources maintained for that purpose. Except for very low levels of ground motion, it is generally not practical to design buildings to meet this performance level.

The immediate occupancy level is similar to the operational level although somewhat more damage to non-structural systems is anticipated. Damage to the structural systems is very slight and the building retains all of its pre-earthquake strength and nearly all of its stiffness. Nonstructural elements, including ceilings and cladding, but also mechanical and electrical components, remain secured and do not represent hazards. The building remains safe to occupy, however, some repair and clean-up is probably required before the building can be restored to normal service. In particular, it is expected that utilities necessary for normal function of all systems will not be available, although those necessary for life safety systems would be provided. Some equipment and systems used in normal function of the building may experience internal damage

due to shaking of the building, but most would be expected to operate if the necessary utility service was available. Similar to the operational level, the risk to life safety during an earthquake in a building meeting this performance level is negligible. Structural repair may be completed at the occupant's convenience, however, significant nonstructural repair and cleanup is probably required before normal function of the building can be restored.

At the life safe level, significant structural and nonstructural damage has occurred. The building may have lost a substantial amount of its original lateral stiffness and strength but still retains a significant margin against collapse. The structure may have permanent lateral offset and some elements of the lateral force resisting system may exhibit substantial cracking, spalling, yielding and buckling. Nonstructural elements of the building, while secured and not presenting falling hazards, are severely damaged and can not function. The building is not safe for continued occupancy until repairs are instituted as strong ground motion from aftershocks could result in life threatening damage. Repair of the building is expected to be feasible, however, it may not be economically attractive to do so. The risk to life during the earthquake, in a building meeting this performance level is very low.

At the near collapse level a building has sustained nearly complete damage. The lateral force resisting system has lost most of its original stiffness and strength and little margin remains against collapse. Substantial degradation of the structural elements has occurred including extensive cracking and spalling of masonry and concrete elements and buckling and fracture of steel elements. The structure may have significant permanent lateral offset. Nonstructural elements of the building have experienced substantial damage and may have become dislodged creating falling hazards. The building is unsafe for occupancy as even relatively moderate ground motion from aftershocks could induce collapse. Repair of the building and restoration to service is probably not practically achievable.

The design ground motion contained in the *Provisions* is taken as two-thirds of the maximum considered earthquake ground motion. Such ground motion may have a return period varying from a few hundred years to a few thousand years, depending on the regional seismicity. It is expected that buildings designed in accordance with the requirements for Group I would achieve the life safe or better performance level for these ground motions. Buildings designed in accordance with the requirements for Group III should be able to achieve the Immediate Occupancy or better performance level for this ground motion. Buildings designed to the requirements for Group II would be expected to achieve performance better than the life safe level but perhaps less than the immediate occupancy level for this ground motion.

While the design ground motion represents a rare earthquake event, it may not be the most severe event that could ever effect a site. In zones of moderate seismicity, it has been common practice in the past to consider ground motion with a 98 percent chance of nonexceedance in 50 years, or an average return period of 2,500 years, as being reasonably representative of the most severe ground motion ever likely to effect a site. This earthquake has been variously termed a maximum credible earthquake, maximum capable event and, most recently, a maximum considered event. The recent terminology is adopted here in recognition that ground motion of this probability level is not the most severe motion that could ever effect the site, but is considered sufficiently improbable that more severe ground motions need not practically be considered. In regions near major active faults, such as coastal California, estimates of ground motion at this probability of

---

exceedance can produce structural demands much larger than has typically been recorded in past earthquakes. Consequently, in these zones, the maximum considered earthquake is now commonly taken based on conservative estimates of the ground motion from a deterministic event, representing the largest magnitude event that the nearby faults are believed capable of producing.

It is expected that buildings designed to the requirements for Group I would be capable of responding to the maximum considered earthquake at a near collapse or better performance level. Structures designed to the requirements for Group III should be capable of responding to such ground motions at the Life Safe level. Structures designed and constructed to the requirements for Group II structures should be capable of responding to maximum considered earthquake ground motions with a performance intermediate to the near collapse and life safe levels.

In zones of high seismicity, buildings may experience strong motion earthquakes several times during their lives. It is also important to consider the performance expected of structures for these somewhat less severe, but much more frequent, events. For this purpose, earthquake ground shaking with a 50 percent probability of nonexceedance in 50 years may be considered. Sometime termed a maximum probable event (MPE), such ground motion would be expected to recur at a site, one time, every 72 years.

Buildings designed to the requirements for Group I would be expected to respond to such ground motion at the Immediate Occupancy level. Buildings designed and constructed to either the Group II or Group III requirements would be expected to perform to the Operational level for these events. This performance is summarized in Figure C1.3.

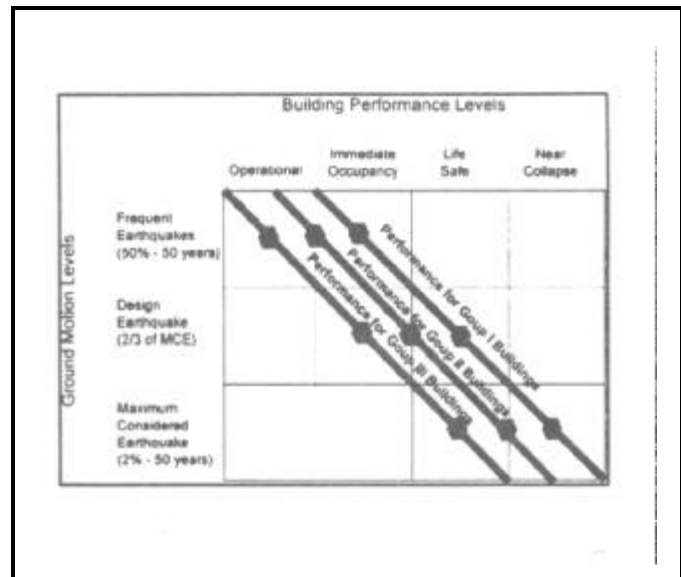

FIGURE C1.3 Expected building performance.

It is important to note that while the performance indicated in Figure C1.3 is generally indicative of that expected for buildings designed in accordance with the *Provisions*, there can be significant variation in the performance of individual buildings from these expectations. This variation results from individual site conditions, quality of construction, structural systems, detailing, overall building configuration, inaccuracies in our analytical techniques and a number of other complex factors. As a result of these many factors, and intentional conservatism contained in the *Provisions*, most buildings will perform better than indicated in the figure and others will not perform as well.

**1.3.5 Group III Structure Access Protection:** This section establishes the requirement for access protection for Seismic Use Group III structures. There is a need for ingress/egress to those structures that are essential post-earthquake facilities and this shall be considered in the siting and design of a structure.



**1.4 OCCUPANCY IMPORTANCE FACTOR:** The concept of an occupancy importance factor has been present for many years in the *Uniform Building Code*; however, it was first adopted into the *Provisions* for the 1997 Edition. This is one of several ways the *Provisions* attempt to control the seismic performance capability of buildings in different Seismic Use Groups. Specifically, the occupancy importance factor modifies the  $R$  coefficients used to determine minimum design base shear forces. Structures assigned occupancy importance factors exceeding 1.0 must be designed for larger base shear forces. As a result, they are expected to experience lower ductility demands than structures designed with lower occupancy importance factors and, hence, would be expected to sustain less damage. The *Provisions* also control structural vulnerability to damage by specifying more stringent drift limits for structures in some Seismic Use Groups. Further discussion of these concepts may be found in *Commentary* Sec. 5.2.1 and 5.2.8.

## Chapter 2 Commentary

### GLOSSARY AND NOTATIONS

The definitions that appear in *Provisions* Chapter 2 are reproduced here to facilitate reference by the reader. Note, however, that in the *Provisions* volume, terms defined in Chapter 2 are printed in italics.

#### 2.1 GLOSSARY:

**Active Fault:** A fault for which there is an average historic slip rate of 1 mm per year or more and geologic evidence of seismic activity within Holocene times (past 11,000 years).

**Addition:** An increase in building area, aggregate floor area, height, or number of stories of a structure.

**Adjusted Resistance:** The reference resistance adjusted to include the effects of all applicable adjustment factors resulting from end use and other modifying factors. Time effect factor ( $\lambda$ ) adjustments are not included.

**Alteration:** Any construction or renovation to an existing structure other than an addition.

**Appendage:** An architectural component such as a canopy, marquee, ornamental balcony, or statuary.

**Approval:** The written acceptance by the authority having jurisdiction of documentation that establishes the qualification of a material, system, component, procedure, or person to fulfill the requirements of these provisions for the intended use.

**Architectural Component Support:** Those structural members or assemblies of members, including braces, frames, struts and attachments, that transmit all loads and forces between architectural systems, components, or elements and the structure.

**Attachments:** Means by which components and their supports are secured or connected to the seismic-force-resisting system of the structure. Such attachments include anchor bolts, welded connections, and mechanical fasteners.

**Base:** The level at which the horizontal seismic ground motions are considered to be imparted to the structure.

**Base Shear:** Total design lateral force or shear at the base.

**Basement.** A basement is any story below the lowest story above grade.

**Boundary Elements:** Diaphragm and shear wall boundary members to which sheathing transfers forces. Boundary members include chords and drag struts at diaphragm and shear wall perimeters, interior openings, discontinuities, and re-entrant corners.

**Braced Wall Line:** A series of braced wall panels in a single story that meets the requirements of Sec. 12.5.2.

**Braced Wall Panel:** A section of wall braced in accordance with Sec. 12.5.2.

**Building:** Any structure whose use could include shelter of human occupants.

**Boundary Members:** Portions along wall and diaphragm edges strengthened by longitudinal and transverse reinforcement and/or structural steel members.

**Cantilevered Column System:** A seismic-force-resisting system in which lateral forces are resisted entirely by columns acting as cantilevers from the foundation.

**Component:** A part or element of an architectural, electrical, mechanical, or structural system.

**Component, Equipment:** A mechanical or electrical component or element that is part of a mechanical and/or electrical system within or without a building system.

**Component, Flexible:** Component, including its attachments, having a fundamental period greater than 0.06 sec.

**Component, Rigid:** Component, including its attachments, having a fundamental period less than or equal to 0.06 sec.

**Concrete:**

**Plain Concrete:** Concrete that is either unreinforced or contains less reinforcement than the minimum amount specified in Ref. 6-1 for reinforced concrete.

**Reinforced Concrete:** Concrete reinforced with no less than the minimum amount required by Ref. 6-1, prestressed or nonprestressed, and designed on the assumption that the two materials act together in resisting forces.

**Confined Region:** That portion of a reinforced concrete component in which the concrete is confined by closely spaced special transverse reinforcement restraining the concrete in directions perpendicular to the applied stress.

**Construction Documents:** The written, graphic, electronic, and pictorial documents describing the design, locations, and physical characteristics of the project required to verify compliance with these Provisions.

**Container:** A large-scale independent component used as a receptacle or vessel to accommodate plants, refuse, or similar uses.

**Coupling Beam:** A beam that is used to connect adjacent concrete wall piers to make them act together as a unit to resist lateral loads.

**Deformability:** The ratio of the ultimate deformation to the limit deformation.

**High Deformability Element:** An element whose deformability is not less than 3.5 when subjected to four fully reversed cycles at the limit deformation.

**Limited Deformability Element:** An element that is neither a low deformability or a high deformability element.

**Low Deformability Element:** An element whose deformability is 1.5 or less.

### **Deformation:**

**Limit Deformation:** Two times the initial deformation that occurs at a load equal to 40 percent of the maximum strength.

**Ultimate Deformation:** The deformation at which failure occurs and which shall be deemed to occur if the sustainable load reduces to 80 percent or less of the maximum strength.

**Design Earthquake Ground Motion:** The earthquake effects that buildings and structures are specifically proportioned to resist as defined in Sec. 4.1.

**Design Earthquake:** Earthquake effects that are two-thirds of the corresponding maximum considered earthquake.

**Designated Seismic System:** Those architectural, electrical, and mechanical systems and their components that require design in accordance with Sec. 6.1 and that have a component importance factor ( $I_p$ ) greater than 1.

**Diaphragm:** A horizontal or nearly horizontal system acting to transfer lateral forces to the vertical resisting elements. Diaphragms are classified as either flexible or rigid according to the requirements of Sec. 5.2.3.1 and 12.3.4.2.

**Diaphragm, Blocked:** A diaphragm in which all sheathing edges not occurring on a framing member are supported on and fastened to blocking.

**Diaphragm Boundary:** A location where shear is transferred into or out of the diaphragm sheathing. Transfer is either to a boundary element or to another force-resisting element.

**Diaphragm Chord:** A diaphragm boundary element perpendicular to the applied load that is assumed to take axial stresses due to the diaphragm moment in a manner analogous to the flanges of a beam. Also applies to shear walls.

### **Displacement**

**Design Displacement:** The design earthquake lateral displacement, excluding additional displacement due to actual and accidental torsion, required for design of the isolation system.

**Total Design Displacement:** The design earthquake lateral displacement, including additional displacement due to actual and accidental torsion, required for design of the isolation system or an element thereof.

**Total Maximum Displacement:** The maximum considered earthquake lateral displacement, including additional displacement due to actual and accidental torsion, required for verification of the stability of the isolation system or elements thereof, design of structure separations, and vertical load testing of isolator unit prototypes.

**Displacement Restraint System:** A collection of structural elements that limits lateral displacement of seismically isolated structures due to maximum considered earthquake ground shaking.

**Drag Strut (Collector, Tie, Diaphragm Strut):** A diaphragm or shear wall boundary element parallel to the applied load that collects and transfers diaphragm shear forces to the vertical-force-resisting elements or distributes forces within the diaphragm or shear wall. A drag strut often is an extension of a boundary element that transfers forces into the diaphragm or shear wall.

**Effective Damping:** The value of equivalent viscous damping corresponding to energy dissipated during cyclic response of the isolation system.

**Effective Stiffness:** The value of the lateral force in the isolation system, or an element thereof, divided by the corresponding lateral displacement.

**Enclosure:** An interior space surrounded by walls.

**Equipment Support:** Those structural members or assemblies of members or manufactured elements, including braces, frames, legs, lugs, snuggers, hangers or saddles, that transmit gravity load and operating load between the equipment and the structure.

**Essential Facility:** A facility or structure required for post-earthquake recovery.

**Factored Resistance ( $\lambda\phi D$ ):** Reference resistance multiplied by the time effect and resistance factors. This value must be adjusted for other factors such as size effects, moisture conditions, and other end-use factors.

**Flexible Equipment Connections:** Those connections between equipment components that permit rotational and/or translational movement without degradation of performance. Examples include universal joints, bellows expansion joints, and flexible metal hose.

**Frame:**

**Braced Frame:** An essentially vertical truss, or its equivalent, of the concentric or eccentric type that is provided in a building frame system or dual frame system to resist shear wall.

**Centrically Braced Frame (CBF):** A braced frame in which the members are subjected primarily to axial forces.

**Eccentrically Braced Frame (EBF):** A diagonally braced frame in which at least one end of each brace frames into a beam a short distance from a beam-column joint or from another diagonal brace.

**Ordinary Centrically Braced Frame (OCBF):** A steel concentrically braced frame in which members and connections are designed in accordance with the provisions of Ref. 8-3 without modification.

**Special Centrically Braced Frame (SCBF):** A steel or composite steel and concrete concentrically braced frame in which members and connections are designed for ductile behavior. Special concentrically braced frames shall conform to Sec. 8.2.1 .

**Moment Frame:** A frame provided with restrained connections between the beams and columns to permit the frame to resist lateral forces through the flexural rigidity and strength of its members.

**Intermediate Moment Frame:** A moment frame of reinforced concrete meeting the detailing requirements of Ref. 9-1, Sec. 21.8, of structural steel meeting the detailing requirements of Ref. 8-3, Sec. 10, or of composite construction meeting the requirements of Ref. 10-3, Part II, Sec. 6.4b, 7, 8 and 10.

**Ordinary Moment Frame:** A moment frame of reinforced concrete conforming to the requirements of Ref. 9-1 exclusive of Chapter 21, of structural steel meeting the detailing requirements of Ref. 8-3, Sec. 12, or of composite construction meeting the requirements of Ref. 10-3, Part II, Sec. 6.4a, 7, 8 and 11.

**Special Moment Frame (SMF):** A moment frame of reinforced concrete meeting the detailing requirements of Ref. 9-1, Sec. 21.2 through 21.5, of structural steel meeting the detailing requirements of Ref. 8-3, Sec. 9, or of composite construction meeting the requirements of Ref. 10-3, Part II, Sec. 6.4a, 7, 8 and 9.

**Frame System:**

**Building Frame System:** A structural system with an essentially complete space frame system providing support for vertical loads. Seismic-force resistance is provided by shear walls or braced frames.

**Dual Frame System:** A structural system with an essentially complete space frame system providing support for vertical loads. Seismic force resistance is provided by a moment resisting frame and shear walls or braced frames as prescribed in Sec. 5.2.2.1.

**Space Frame System:** A structural system composed of interconnected members, other than bearing walls, that is capable of supporting vertical loads and that also may provide resistance to shear wall.

**Grade Plane.** A reference plane representing the average of finished ground level adjoining the structure at all exterior walls. Where the finished ground level slopes away from the exterior walls, the reference plane shall be established by the lowest points within the area between the buildings and the lot line or, where the lot line is more than 6 ft. (1829 mm) from the structure, between the structure and a point 6 ft. (1829 mm) from the structure.

**Hazardous Contents:** A material that is highly toxic or potentially explosive and in sufficient quantity to pose a significant life-safety threat to the general public if an uncontrolled release were to occur.

**High Temperature Energy Source:** A fluid, gas, or vapor whose temperature exceeds 220 degrees F (378 K).

**Inspection, Special:** The observation of the work by the special inspector to determine compliance with the approved construction documents and these *Provisions*.

**Continuous Special Inspection:** The full-time observation of the work by an approved special inspector who is present in the area where work is being performed.

**Periodic Special Inspection:** The part-time or intermittent observation of the work by an approved special inspector who is present in the area where work has been or is being performed.

**Inspector, Special (who shall be identified as the Owner's Inspector):** A person approved by the authority having jurisdiction as being qualified to perform special inspection required by the approved quality assurance plan. The quality assurance personnel of a fabricator is permitted to be approved by the authority having jurisdiction as a special inspector.

**Inverted Pendulum Type Structures:** Structures that have a large portion of their mass concentrated near the top and, thus, have essentially one degree of freedom in horizontal translation. The structures are usually T-shaped with a single column supporting the beams or framing at the top.

**Isolation Interface:** The boundary between the upper portion of the structure, which is isolated, and the lower portion of the structure, which moves rigidly with the ground.

**Isolation System:** The collection of structural elements that includes all individual isolator units, all structural elements that transfer force between elements of the isolation system, and all connections to other structural elements. The isolation system also includes the wind-restraint system, energy-dissipation devices, and/or the displacement restraint system if such systems and devices are used to meet the design requirements of Chapter 13.

**Isolator Unit:** A horizontally flexible and vertically stiff structural element of the isolation system that permits large lateral deformations under design seismic load. An isolator unit is permitted to be used either as part of or in addition to the weight-supporting system of the structure.

**Joint:** That portion of a column bounded by the highest and lowest surfaces of the other members framing into it.

**Load:**

**Dead Load:** The gravity load due to the weight of all permanent structural and nonstructural components of a building such as walls, floors, roofs, and the operating weight of fixed service equipment.

**Gravity Load (W):** The total dead load and applicable portions of other loads as defined in Sec. 5.3.2.

**Live Load:** The load superimposed by the use and occupancy of the building not including the wind load, earthquake load, or dead load; see Sec. 5.3.2.

**Maximum Considered Earthquake Ground Motion:** The most severe earthquake effects considered by these *Provisions* as defined in Sec. 4.1.

**Nonbuilding Structure:** A structure, other than a building, constructed of a type included in Chapter 14 and within the limits of Sec. 14.1.1.

**Occupancy Importance Factor:** A factor assigned to each structure according to its Seismic Use Group as prescribed in Sec. 1.4.

**Owner:** Any person, agent, firm, or corporation having a legal or equitable interest in the property.

**Partition:** A nonstructural interior wall that spans from floor to ceiling, to the floor or roof structure immediately above, or to subsidiary structural members attached to the structure above.

**P-Delta Effect:** The secondary effect on shears and moments of structural members induced due to displacement of the structure.

**Quality Assurance Plan:** A detailed written procedure that establishes the systems and components subject to special inspection and testing.

**Reference Resistance:** The resistance (force or moment as appropriate) of a member or connection computed at the reference end use conditions.

**Registered Design Professional:** An architect or engineer, registered or licensed to practice professional architecture or engineering, as defined by the statutory requirements of the professional registrations laws of the state in which the project is to be constructed.

**Roofing Unit:** A unit of roofing material weighing more than 1 pound (0.5 kg).

**Seismic Design Category:** A classification assigned to a structure based on its Seismic Use Group and the severity of the design earthquake ground motion at the site.

**Seismic-Force-Resisting System:** That part of the structural system that has been considered in the design to provide the required resistance to the shear wall prescribed herein.

**Seismic Forces:** The assumed forces prescribed herein, related to the response of the structure to earthquake motions, to be used in the design of the structure and its components.

**Seismic Response Coefficient:** Coefficient  $C_s$  as determined from Sec. 5.3.2.1.

**Seismic Use Group:** A classification assigned to a structure based on its use as defined in Sec. 1.3.

**Shallow Anchors:** Anchors with embedment length-to-diameter ratios of less than 8.

**Shear Panel:** A floor, roof, or wall component sheathed to act as a shear wall or diaphragm.

**Site Class:** A classification assigned to a site based on the types of soils present and their engineering properties as defined in Sec. 4.1.2.

**Site Coefficients:** The values of  $F_a$  and  $F_v$  indicated in Tables 1.4.2.3a and 1.4.2.3b, respectively.

**Special Transverse Reinforcement:** Reinforcement composed of spirals, closed stirrups, or hoops and supplementary cross-ties provided to restrain the concrete and qualify the portion of the component, where used, as a confined region.

**Storage Racks:** Include industrial pallet racks, movable shelf racks, and stacker racks made of cold-formed or hot-rolled structural members. Does not include other types of racks such as



drive-in and drive-through racks, cantilever racks, portable racks, or racks made of materials other than steel.

**Story:** The portion of a structure between the top of two successive finished floor surfaces and, for the topmost story, from the top of the floor finish to the top of the roof structural element.

**Story Above Grade:** Any story having its finished floor surface entirely above grade, except that a story shall be considered as a story above grade where the finished floor surface of the story immediately above is more than 6 ft (1829 mm) above the grade plane, more than 6 ft (1829 mm) above the finished ground level for more than 40 percent of the total structure perimeter, or more than 12 ft (3658 mm) above the finished ground level at any point. This definition is illustrated in Figure 2.1.

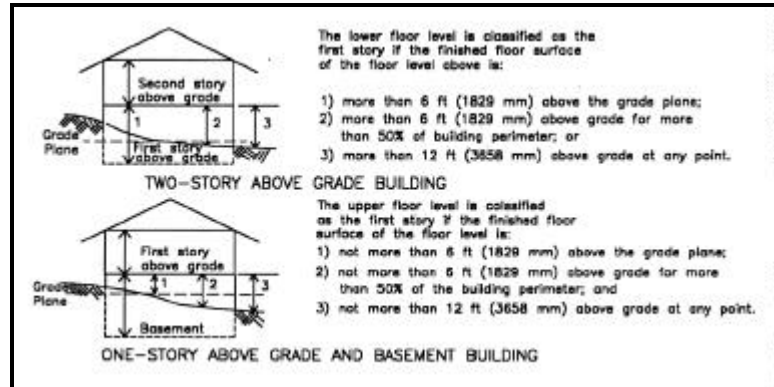

FIGURE 2.1 Definition of story above grade.

**Story Drift Ratio:** The story drift, as determined in Sec. 5.3.7, divided by the story height.

**Story Shear:** The summation of design lateral forces at levels above the story under consideration.

**Strength:**

**Design Strength:** Nominal strength multiplied by a strength reduction factor,  $\phi$ .

**Nominal Strength:** Strength of a member or cross section calculated in accordance with the requirements and assumptions of the strength design methods of these Provisions (or the referenced standards) before application of any strength reduction factors.

**Required Strength:** Strength of a member, cross section, or connection required to resist factored loads or related internal moments and forces in such combinations as stipulated by these Provisions.

**Structure:** That which is built or constructed and limited to buildings and nonbuilding structures as defined herein.

**Structural Observations:** The visual observations performed by the registered design professional in responsible charge (or another registered design professional) to determine that the seismic-force-resisting system is constructed in general conformance with the construction documents.

**Structural-Use Panel:** A wood-based panel product that meets the requirements of Ref. 12-10 or 12-11 and is bonded with a waterproof adhesive. Included under this designation are plywood, oriented strand board, and composite panels.

**Subdiaphragm:** A portion of a diaphragm used to transfer wall anchorage forces to diaphragm cross ties.

**Testing Agency:** A company or corporation that provides testing and/or inspection services. The person in responsible charge of the special inspector(s) and the testing services shall be a registered design professional.

**Tie-Down (Hold-Down):** A device used to resist uplift of the chords of shear walls. These devices are intended to resist load without significant slip between the device and the shear wall chord or be shown with cyclic testing to not reduce the wall capacity or ductility.

**Time Effect Factor:** A factor applied to the adjusted resistance to account for effects of duration of load.

**Torsional Force Distribution:** The distribution of horizontal shear wall through a rigid diaphragm when the center of mass of the structure at the level under consideration does not coincide with the center of rigidity (sometimes referred to as diaphragm rotation).

**Toughness:** The ability of a material to absorb energy without losing significant strength.

**Utility or Service Interface:** The connection of the structure's mechanical and electrical distribution systems to the utility or service company's distribution system.

**Veneers:** Facings or ornamentation of brick, concrete, stone, tile, or similar materials attached to a backing.

**Wall:** A component that has a slope of 60 degrees or greater with the horizontal plane used to enclose or divide space.

**Bearing Wall:** An exterior or interior wall providing support for vertical loads.

**Cripple Wall:** A framed stud wall, less than 8 feet (2400 mm) in height, extending from the top of the foundation to the underside of the lowest floor framing. Cripple walls can occur in both engineered structures and conventional construction.

**Light-Framed Wall:** A wall with wood or steel studs.

**Light-Framed Wood Shear Wall:** A wall constructed with wood studs and sheathed with material rated for shear resistance.

**Nonbearing Wall:** An exterior or interior wall that does not provide support for vertical loads other than its own weight or as permitted by the building code administered by the authority having jurisdiction.

**Nonstructural Wall:** All walls other than bearing walls or shear walls.

**Shear Wall (Vertical Diaphragm):** A wall designed to resist lateral forces parallel to the plane of the wall (sometimes referred to as a vertical diaphragm).

**Wall System, Bearing:** A structural system with bearing walls providing support for all or major portions of the vertical loads. Shear walls or braced frames provide seismic-force resistance.

**Wind-Restraint System:** The collection of structural elements that provides restraint of the seismic-isolated structure for wind loads. The wind-restraint system may be either an integral part of isolator units or a separate device.

## 2.2 NOTATIONS:

A, B, C, D, E, F	Site classes as defined in Sec. 4.1.2.
$A_b$	Area (in. <sup>2</sup> or mm <sup>2</sup> ) of anchor bolt or stud in Chapters 6 and 11.
$A_{ch}$	Cross-sectional area (in. <sup>2</sup> or mm <sup>2</sup> ) of a component measured to the outside of the special lateral reinforcement.
$A_n$	Net cross-sectional area of masonry (in. <sup>2</sup> or mm <sup>2</sup> ) in Chapter 11.
$A_o$	The area of the load-carrying foundation (ft <sup>2</sup> or m <sup>2</sup> ).
$A_p$	The area of an assumed failure surface taken as a pyramid in Eq. 9.2.4.1-3 or in Chapter 9.
$A_p$	Projected area on the masonry surface of a right circular cone for anchor bolt allowable shear and tension calculations (in. <sup>2</sup> or mm <sup>2</sup> ) in Chapter 11.
$A_s$	The area of an assumed failure surface taken as a pyramid in Eq. .2.4.1-3 or in Chapter 9.
$A_s$	Cross-sectional area of reinforcement (in. <sup>2</sup> or mm <sup>2</sup> ) in Chapters 6 and 11.
$A_{sh}$	Total cross-sectional area of hoop reinforcement (in. <sup>2</sup> or mm <sup>2</sup> ), including supplementary cross-ties, having a spacing of $s_h$ and crossing a section with a core dimension of $h_c$ .
$A_t$	The area (in. <sup>2</sup> or mm <sup>2</sup> ) of the flat bottom of the truncated pyramid of an assumed concrete failure surface in Sec. 9.2.4.1 or Eq. 9.2.4.1-3.
$A_{vd}$	Required area of leg (in. <sup>2</sup> or mm <sup>2</sup> ) of diagonal reinforcement.
$A_x$	The torsional amplification factor.
$a_b$	Length of compressive stress block (in. or mm) in Chapter 11.
$a_d$	The incremental factor related to P-delta effects in Sec. 5.3.6.2.
$a_p$	The component amplification factor as defined in Sec. 6.1.3.
$B_a$	Nominal axial strength of an anchor bolt (lb or N) in Chapter 11.
$B_D$	Numerical coefficient as set forth in Table 13.3.3.1 for effective damping equal to $D$ .
$B_M$	Numerical coefficient as set forth in Table 13.3.3.1 for effective damping equal to $M$ .
$B_v$	Nominal shear strength of an anchor bolt (lb or N) in Chapter 11.

---

$b$	The shortest plan dimension of the <i>structure</i> , in feet (mm), measured perpendicular to $d$ .
$b_a$	Factored axial force on an anchor bolt (lb or N) in Chapter 11.
$b$	The shortest plan dimension of the <i>structure</i> , in feet (mm), measured perpendicular to $d_p$ (Sec. 5.6).
$b_v$	Factored shear force on an anchor bolt (lb or N) in Chapter 11.
$b_w$	Web width (in. or mm) in Chapter 11.
$C_u$	Coefficient for upper limit on calculated period; see Table 5.3.3.
$C_d$	The deflection amplification factor as given in Table 5.2.2.
$C_s$	The seismic response coefficient (dimensionless) determined in Sec. 5.3.
$C_s^c$	The seismic response coefficient (dimensionless) determined in Sec. 5.5.2.1 and 5.5.3.1.
$C_{sm}$	The modal seismic response coefficient (dimensionless) determined in Sec. 5.4.5.
$C_T$	The building period coefficient in Sec. 5.3.3.1.
$C_{vx}$	The vertical distribution factor as determined in Sec. 5.3.4.
$c$	Distance from the neutral axis of a flexural member to the fiber of maximum compressive strain (in. or mm).
$c_{eq}$	Effective energy dissipation device damping coefficient (Eq. 13.3.2.1).
$D$	Reference resistance in Chapter 12.
$D$	The effect of dead load in Sec. 5.2.7 and Chapter 13.
$D'$	Adjusted resistance in Chapter 12.
$D_D$	Design displacement, in inches (mm), at the center of rigidity of the <i>isolation system</i> in the direction under consideration as prescribed by Eq. 13.3.3.1.
$D_D'$	Design displacement, in inches (mm), at the center of rigidity of the isolation system in the direction under consideration, as prescribed by Eq. 13.4.2-1.
$D_M$	Maximum displacement, in inches (mm), at the center of rigidity of the isolation system in the direction under consideration, as prescribed by Eq. 13.3.3.3.
$D_M'$	Maximum displacement, in inches (mm), at the center of rigidity of the isolation system in the direction under consideration, as prescribed by Eq. 13.4.2-2 .
$D_p$	Relative seismic displacement that the component must be designed to accommodate as defined in Sec. 6.1.4.

---

$D_s$	The total depth of the stratum in Eq. 5.5.2.1.2-4 (ft or m).
$D_{TD}$	Total design displacement, in inches (mm), of an element of the isolation system including both translational displacement at the center of rigidity and the component of torsional displacement in the direction under consideration as prescribed by Eq. 13.3.3.5-1.
$D_{TM}$	Total maximum displacement, in inches (mm), of an element of the isolation system including both translational displacement at the center of rigidity and the <i>component</i> of torsional displacement in the direction under consideration as prescribed by Eq. 13.3.3.5-2.
$d$	Overall depth of member (in. or mm) in Chapters 5 and 11.
$d$	The longest plan dimension of the structure, in ft (mm), in Chapter 13.
$d_b$	Diameter of reinforcement (in. or mm) in Chapter 11.
$d_e$	Distance from the anchor axis to the free edge (in. or mm) in Chapter 9.
$d_p$	The longest plan dimension of the structure, in feet (mm).
$E$	The effect of horizontal and vertical earthquake-induced forces (Sec. 5.2.7 and Chapter 13).
$E_{loop}$	Energy dissipated in kip-inches (kN-mm), in an isolator unit during a full cycle of reversible load over a test displacement range from $\Delta^+$ to $\Delta^-$ , as measured by the area enclosed by the loop of the force-deflection curve.
$E_m$	Chord modulus of elasticity of masonry (psi or MPa) in Chapter 11.
$E_s$	Modulus of elasticity of reinforcement (psi or MPa) in Chapter 11.
$E_v$	Modulus of rigidity of masonry (psi or MPa) in Chapter 11.
$e$	The actual eccentricity, in feet (mm), measured in plan between the center of mass of the structure above the isolation interface and the center of rigidity of the isolation system, plus accidental eccentricity, in feet (mm), taken as 5 percent of the maximum building dimension perpendicular to the direction of force under consideration.
$F_a$	Acceleration-based site coefficient (at 0.3 sec period).
$F^-$	Maximum negative force in an isolator unit during a single cycle of prototype testing at a displacement amplitude of $\Delta^-$ .
$F^+$	Positive force in kips (kN) in an isolator unit during a single cycle of prototype testing at a displacement amplitude of $\Delta^+$ .
$F_i, F_n, F_x$	The portion of the seismic base shear, $V$ , induced at Level $I$ , $n$ , or $x$ , respectively, as determined in Sec. 5.3.4 (kip or kN).
$F_p$	The seismic design force center of gravity and distributed relative to the <i>component's</i> weight distribution as determined in Sec. 6.1.3.

---

$F_p$	The induced seismic force on connections and anchorages as determined in Sec. 5.2.5.1.
$F_u$	Specified ultimate tensile strength (psi or MPa) of an anchor (Sec. 9.2.4).
$F_v$	Velocity-based site coefficient (at 1.0 sec period).
$F_x$	Total force distributed over the height of the structure above the isolation interface as prescribed by Eq. 13.3.5.
$F_{xm}$	The portion of the seismic base shear, $V_m$ , induced at Level $x$ as determined in Sec. 5.4.6 (kip or kN).
$f_c'$	Specified compressive strength of concrete used in design.
$f_m'$	Specified compressive strength of masonry (psi or MPa) at the age of 28 days unless a different age is specified, Chapter 11.
$f_r$	Modulus of rupture of masonry (psi or MPa) in Chapter 11.
$f_s'$	Ultimate tensile strength (psi or MPa) of the bolt, stud, or insert leg wires. For A307 bolts or A108 studs, is permitted to be assumed to be 60,000 psi (415 MPa).
$f_y$	Specified yield strength of reinforcement (psi or MPa).
$f_{yh}$	Specified yield stress of the special lateral reinforcement (psi or kPa).
$G$	$v_s^2/g$ = the average shear modulus for the soils beneath the foundation at large strain levels (psf or Pa).
$G_o$	$v_{so}^2/g$ = the average shear modulus for the soils beneath the foundation at small strain levels (psf or Pa).
$g$	Acceleration of gravity in in./sec <sup>2</sup> (mm/s <sup>2</sup> ).
$H$	Thickness of soil.
$h$	The height of a shear wall measured as the maximum clear height from the foundation to the bottom of the floor or roof framing above or the maximum clear height from the top of the floor or roof framing to the bottom of the floor or roof framing above.
$\bar{h}$	The effective height of the building as determined in Sec. 5.5.2 or 5.5.3 (ft or m).
$h$	Height of a wood shear panel or diaphragm (ft or mm) in Chapter 12.
$h$	The roof elevation of a structure in Chapter 6.
$h$	Height of the member between points of support (in. or mm) in Chapter 11.
$h_c$	The core dimension of a component measured to the outside of the special lateral reinforcement (in. or mm).

---

$h_i, h_n, h_x$	The height above the <i>base</i> Level $I, n,$ or $x,$ respectively (ft or m).
$h_{sx}$	The story height below Level $x = h_x - h_{x-1}$ (ft or m).
$I$	The occupancy importance factor in Sec. 1.4.
$I_{cr}$	Moment of inertia of the cracked section (in. <sup>4</sup> or mm <sup>4</sup> ) in Chapter 11.
$I_n$	Moment of inertia of the net cross-sectional area of a member (in. <sup>4</sup> or mm <sup>4</sup> ) in Chapter 11.
$I_o$	The static moment of inertia of the load-carrying foundation; see Sec. 5.5.2.1 (in <sup>4</sup> or mm <sup>4</sup> ).
$I_p$	The component importance factor as prescribed in Sec. 6.1.5.
$I$	The building level referred to by the subscript $I$ ; $I = 1$ designates the first level above the base.
$K_p$	The stiffness of component or attachment as defined in Sec. 6.3.3.
$K_y$	The lateral stiffness of the foundation as defined in Sec. 5.5.2.1.1 (lb/in. or N/m).
$K$	The rocking stiffness of the foundation as defined in Sec. 5.5.2.1.1 (ft·lb/degree or N·m/rad).
$KL/r$	The lateral slenderness of a compression member measured in terms of its effective buckling length, $KL,$ and the least radius of gyration of the member cross section, $r.$
$k$	The distribution exponent given in Sec. 5.3.4
$K_{dmax}$	Maximum effective stiffness, in kips/inch (kN/mm), of the isolation system at the design displacement in the horizontal direction under consideration as prescribed by Eq. 13.9.5.1-1.
$K_{Dmin}$	Minimum effective stiffness, in kips/inch (kN/mm), of the isolation system at the design displacement in the horizontal direction under consideration as prescribed by Eq. 13.9.5.1-2.
$K_{max}$	Maximum effective stiffness, in kips/inch (kN/mm), of the isolation system at the maximum displacement in the horizontal direction under consideration as prescribed by Eq. 13.9.5.1-3.
$K_{Min}$	Minimum effective stiffness, in kips/inch (kN/mm), of the isolation system at the maximum displacement in the horizontal direction under consideration, as prescribed by Eq. 13.9.5.1-4.
$k_{eff}$	Effective stiffness of an isolator unit, as prescribed by Eq. 13.9.3-1.
$\bar{k}$	The stiffness of the building as determined in Sec. 5.5.2.1.1 (lb/ft or N/m).

---

$L$	The overall length of the building (ft or m) at the base in the direction being analyzed.
$L$	Length of bracing member (in. or mm) in Chapter 8.
$L$	Length of coupling beam between coupled shear walls in Chapter 11 (in. or mm).
$L$	The effect of live load in Chapter 13.
$L_o$	The overall length of the side of the foundation in the direction being analyzed, Sec. 5.5.2.1.2 (ft or m).
$l$	The dimension of a diaphragm perpendicular to the direction of application of force. For open-front structures, $l$ is the length from the edge of the diaphragm at the open front to the vertical resisting elements parallel to the direction of the applied force. For a cantilevered diaphragm, $l$ is the length of the cantilever.
$l_b$	Effective embedment length of anchor bolt (in. or mm) in Chapter 11.
$l_{be}$	Anchor bolt edge distance (in. or mm) in Chapter 11.
$l_d$	Development length (in. or mm) in Chapter 11.
$l_{dh}$	Equivalent development length for a standard hook (in. or mm) in Chapter 11.
$l_{ld}$	Minimum lap splice length (in. or mm) in Chapter 11.
$M$	Moment on a masonry section due to unfactored loads (in.·lb or N·mm) in Chapter 11.
$M_a$	Maximum moment in a member at stage deflection is computed (in.·lb or N·mm) in Chapter 11.
$M_{cr}$	Cracking moment strength of the masonry (in.·lb or N·mm) in the Chapter 11.
$M_d$	Design moment strength (in.·lb or N·mm) in Chapter 11.
$M_f$	The foundation overturning design moment as defined in Sec. 5.3.6 (ft·kip or kN·m).
$M_o, M_{ol}$	The overturning moment at the foundation-soil interface as determined in Sec. 5.5.2.3 and 5.5.3.2 (ft·lb or N·m).
$M_{nb}$	Unfactored ultimate moment capacity at balanced strain conditions (Sec. 7.5.3.4).
$M_t$	The torsional moment resulting from the location of the building masses, Sec. 5.3.5.1 (ft·kip or kN·m).
$M_{ta}$	The accidental torsional moment as determined in Sec. 5.3.5.1 (ft·kip or kN·m).

---



$M_u$	Required flexural strength due to factored loads (in·lb or N·mm) in Chapter 11.
$M_1, M_2$	Nominal moment strength at the ends of the coupling beam (in·lb or N·mm) in Chapter 11.
$M_x$	The building overturning design moment at Level $x$ as defined in Sec. 5.3.6 or Sec. 5.4.10 (ft·kip or kN·m).
$m$	A subscript denoting the mode of vibration under consideration; i.e., $m = 1$ for the fundamental mode.
$N$	Number of stories, Sec. 5.3.3.1.
$N$	Standard penetration resistance, ASTM D1536-84.
$N$	Average field standard penetration test for the top 100 ft (30 m); see Sec. 4.1.2.1.
$N_{ch}$	Average standard penetration for cohesionless soil layers for the top 100 ft (30 m); see Sec. 4.1.2.1.
$N_v$	Force acting normal to shear surface (lb or N) in Chapter 11.
$n$	Designates the level that is uppermost in the main portion of the building.
$n$	Number of anchors (Sec. 9.2.4).
$P$	Axial load on a masonry section due to unfactored loads (lb or N) in Chapter 11.
$P_c$	Design tensile strength governed by concrete failure of anchor bolts (Sec. 9.2.4).
$P_D$	Required axial strength on a column resulting from application of dead load, $D$ , in Chapter 5 (kip or kN).
$P_E$	Required axial strength on a column resulting from application of the amplified earthquake load, $E'$ , in Chapter 5 (kip or kN).
$P_L$	Required axial strength on a column resulting from application of live load, $L$ , in Chapter 5 (kip or kN).
$P_n$	Nominal axial load strength (lb or N) in Chapter 8.
$P_n$	The algebraic sum of the shear wall and the minimum gravity loads on the joint surface acting simultaneously with the shear (lb or N).
$P_n$	Nominal axial load strength (lb or N) in Chapter 11.
$P_s$	Design tensile strength governed by steel of anchor bolts in Chapter 9.
$P_u$	Required axial load (lb or N) in Chapter 11.
$P_u$	Tensile strength required due to factored loads (lb or N) in Chapter 9.

---

$P_u^*$	Required axial strength on a brace (kip or kN) in Chapter 8.
$P_x$	The total unfactored vertical design load at and above Level $x$ (kip or kN).
$PI$	Plasticity index, ASTM D4318-93.
$Q_E$	The effect of horizontal building forces (kip or kN); see Sec. 5.2.6.
$Q_V$	The load equivalent to the effect of the horizontal and vertical shear strength of the vertical segment, Appendix to Chapter 8.
$R$	The response modification coefficient as given in Table 5.2.2.
$R_I$	Numerical coefficient related to the type of lateral-force-resisting system above the isolation system as set forth in Table 13.3.4.2 for seismically isolated structures.
$R_p$	The component response modification factor as defined in Sec. 6.1.3.
$r$	A characteristic length of the foundation as defined in Sec. 5.5.2.1 (ft or m).
$r$	Radius of gyration (in. or mm) in Chapter 11.
$r_a$	The characteristic foundation length defined by Eq. 5.5.2.1.2-2 (ft or m).
$r_m$	The characteristic foundation length as defined by Eq. 5.5.2.1.2-3 (ft or m).
$r_x$	The ratio of the design story shear resisted by the most heavily loaded single element in the story, in direction $x$ , to the total story shear.
$S$	Section modulus based on net cross sectional area of a wall (in. <sup>3</sup> or mm <sup>3</sup> ) in Chapter 11.
$S_I$	The mapped maximum considered earthquake, 5% damped, spectral response acceleration at a period of 1 second as defined in Sec. 4.1.1.
$S_{DI}$	The design, 5% damped, spectral response acceleration at a period of one second as defined in Sec. 4.1.2.
$S_{DS}$	The design, 5% damped, spectral response acceleration at short periods as defined in Sec. 4.1.2.
$S_{MI}$	The maximum considered earthquake, 5 percent damped, spectral response acceleration at a period of 1 second adjusted for Site Class effects as defined in Sec. 4.1.2.
$S_{MS}$	The maximum considered earthquake, 5% damped, spectral response acceleration at short periods adjusted for Site Class effects as defined in Sec. 4.1.2.
$S_S$	The mapped maximum considered earthquake, 5% damped, spectral response acceleration at short periods as defined in Sec. 4.1.2.
$S_{pr}$	Probable strength of precast element connectors (Sec. 9A.5.1).

---

$\bar{s}_u$	Average undrained shear strength in top 100 ft (30.5 m); see Sec. 4.1.2.1, ASTM D2166-91 or ASTM D2850-87.
$s_h$	Spacing of special lateral reinforcement (in. or mm).
$T$	The fundamental period (sec) of the building as determined in Sec. 5.3.3 or the modal period (sec) of the building modified as appropriate to account for the effective stiffness of the energy dissipation system (Sec. 13.3.2.1).
$T, T_I$	The effective fundamental period (sec) of the building as determined in Sec. 5.5.2.1.1 and 5.5.3.1.
$T_a$	The approximate fundamental period (sec) of the building as determined in Sec. 5.3.3.1.
$T_D$	Effective period, in seconds (sec), of the seismically isolated structure at the design displacement in the direction under consideration as prescribed by Eq. 13.3.3.2.
$T_p$	The fundamental period (sec) of the component and its attachment(s) as defined in Sec. 6.3.3.
$T_0$	$0.2S_{DI}/S_{DS}$ .
$T_S$	$S_{DI}/S_{DS}$ .
$T_M$	Effective period, in seconds (sec), of the seismically isolated structure at the maximum displacement in the direction under consideration as prescribed by Eq. 13.3.3.4.
$T_m$	The modal period of vibration (sec) of the $m^{\text{th}}$ mode of the building as determined in Sec. 5.4.5.
$T_4$	Net tension in steel cable due to dead load, prestress, live load, and seismic load (Sec. 8.5).
$t$	Specified wall thickness dimension or least lateral dimension of a column (in. or mm) in Chapter 11.
$t_c$	Thickness of masonry cover over reinforcing bars measured from the surface of the masonry to the surface of the reinforcing bars (in. or mm) in Chapter 11.
$V$	The total design lateral force or shear at the <i>base</i> (kip or kN).
$V$	Shear on a masonry section due to unfactored loads (lb or N) in Chapter 11.
$V_b$	The total lateral seismic design force or shear on <i>elements</i> of the isolation system or elements below the isolation system as prescribed by Eq. 13.3.4.1.
$V_m$	Shear strength provided by masonry (lb or N) in Chapter 11.
$V_n$	Nominal shear strength (lb or N) in Chapter 11.

---

$V_s$	The total lateral seismic design force or shear on elements above the isolation system as prescribed by Eq. 13.3.4.2.
$V_s$	Shear strength provided by shear reinforcement (lb or N) in Chapters 6 and 11.
$V_t$	The design value of the seismic <i>base shear</i> as determined in Sec. 5.4.8 (kip or N).
$V_u$	Required shear strength (lb or N) due to factored loads in Chapters 6 and 11.
$V_x$	The seismic design shear in Story $x$ as determined in Sec. 5.3.5 or Sec. 5.4.8 (kip or kN).
$\bar{V}_1$	The portion of the seismic base shear, $\bar{V}$ , contributed by the fundamental mode, Sec. 5.5.3 (kip or kN).
$V$	The reduction in $V$ as determined in Sec. 5.5.2 (kip or kN).
$V_i$	The reduction in $V_i$ as determined in Sec. 5.5.3 (kip or kN).
$v_s$	The average shear wave velocity for the soils beneath the foundation at large strain levels, Sec. 5.5.2 (ft/s or m/s).
$\bar{v}_s$	Average shear wave velocity in top 100 ft (30 m); see Sec. 4.1.2.1.
$v_{so}$	The average shear wave velocity for the soils beneath the foundation at small strain levels, Sec. 5.5.2 (ft/s or m/s).
$W$	The total gravity load of the building as defined in Sec. 5.3.2 (kip or kN). For calculation of seismic-isolated building period, $W$ is the total seismic dead load weight of the building as defined in Sec. 5.5.2 and 5.5.3 (kip or kN).
$\bar{W}$	The effective gravity load of the building as defined in Sec. 5.5.2 and 5.5.3 (kip or kN).
$W_D$	The energy dissipated per cycle at the story displacement for the design earthquake (Sec. 13.3.2).
$\bar{W}_m$	The effective modal gravity load determined in accordance with Eq. 5.4.5-1 (kip or kN).
$W_p$	Component operating weight (lb or N).
$w$	Width of a wood shear panel or diaphragm in Chapter 9 (ft or mm).
$w$	Moisture content (in percent), ASTM D2216-92.
$w$	The dimension of a diaphragm or shear wall in the direction of application of force.
$w_i, w_x$	The portion of the total gravity load, $W$ , located or assigned to Level $i$ or $x$ (kip or kN).
$z$	The level under consideration; $x = 1$ designates the first level above the <i>base</i> .

---

<i>x</i>	Elevation in structure of a component addressed by Chapter 6.
<i>y</i>	Elevation difference between points of attachment in Chapter 6.
<i>y</i>	The distance, in feet (mm), between the center of rigidity of the isolation system rigidity and the element of interest measured perpendicular to the direction of seismic loading under consideration Chapter 13).
	The relative weight density of the structure and the soil as determined in Sec. 5.5.2.1.
	Angle between diagonal reinforcement and longitudinal axis of the member (degree or rad).
	Ratio of shear demand to shear capacity for the story between Level <i>x</i> and <i>x</i> - 1.
$\tilde{}$	The fraction of critical damping for the coupled structure-foundation system, determined in Sec. 5.5.2.1.
<i>D</i>	Effective damping of the isolation system at the design displacement as prescribed by Eq. 13.9.5.2-1.
<i>M</i>	Effective damping of the isolation system at the maximum displacement as prescribed by Eq. 13.9.5.2-2.
<i>o</i>	The foundation damping factor as specified in Sec. 5.5.2.1.
<i>eff</i>	Effective damping of the isolation system as prescribed by Eq. 13.9.3-2.
	Lightweight concrete factor (Sec. 9.2.4.1).
	The average unit weight of soil (lb/ft <sup>3</sup> or kg/m <sup>3</sup> ).
	The design story drift as determined in Sec. 5.3.7.1 (in. or mm).
	The displacement of the dissipation device and device supports across the story (Sec. 13.3.2.1).
	Suspended ceiling lateral deflection (calculated) in Sec. 6.2.6.4.2 (in. or mm).
<i>a</i>	The allowable story drift as specified in Sec. 5.2.7 (in. or mm).
<i>m</i>	The design modal story drift determined in Sec. 5.4.6 (in. or mm)
<i>p</i>	Relative displacement that the component must be designed to accommodate as defined in Sec. 6.2.2.2 or 6.3.2.2.
<i>cr</i>	Deflection based on cracked section properties (in. or mm) in Chapter 11.
<i>+</i>	Maximum positive displacement of an isolator unit during each cycle of prototype testing.
<i>-</i>	Maximum negative displacement of an isolator unit during each cycle of prototype testing.

---

$max$	The maximum displacement at Level $x$ (in. or mm).
$avg$	The average of the displacements at the extreme points of the structure at Level $x$ (in. or mm).
$x$	The deflection of Level $x$ at the center of the mass at and above Level $x$ , Eq. 5.3.7.1 (in. or mm).
$x_e$	The deflection of Level $x$ at the center of the mass at and above Level $x$ determined by an elastic analysis, Sec. 5.3.7.1 (in. or mm).
$x_{em}$	The modal deflection of Level $x$ at the center of the mass at and above Level $x$ determined by an elastic analysis, Sec. 5.4.6 (in. or mm).
$x_m, \tilde{x}_m$	The modal deflection of Level $x$ at the center of the mass at and above Level $x$ as determined by Eq. 5.4.6-3 and 5.5.3.2-1 (in. or mm).
$\tilde{x}, \tilde{x}_l$	The deflection of Level $x$ at the center of the mass at and above Level $x$ , Eq. 5.5.2.3 and 5.5.3.2-1 (in. or mm).
$\epsilon_{mu}$	Maximum usable compressive strain of masonry (in./in. or mm/mm) in Chapter 11.
	The stability coefficient for P-delta effects as determined in Sec. 5.3.6.2.
	The overturning moment reduction factor (Sec. 5.3.6).
	A reliability coefficient based on the extent of structural redundance present in a building as defined in Sec. 5.2.7.
	Ratio of the area of reinforcement to the net cross sectional area of masonry in a plane perpendicular to the reinforcement in Chapter 11.
$b$	Reinforcement ratio producing balanced strain conditions in Chapter 11.
$h$	Ratio of the area of shear reinforcement to the cross sectional area of masonry in a plane perpendicular to the reinforcement in Chapter 11.
$s$	Spiral reinforcement ratio for precast prestressed piles in Sec. 7.5.3.4.
$v$	Ratio of vertical or horizontal reinforcement in <i>walls</i> (Ref. 7-2).
$x$	A reliability coefficient based on the extent of structural redundancy present in the seismic-force-resisting system of a building in the $x$ direction.
$\lambda$	Time effect factor.
	The capacity reduction factor.
	Strength reduction factor in Chapters 6 and 11.
	Resistance factor for steel in Chapter 8 and wood in Chapter 12.
$i_m$	The displacement amplitude at the $i^{\text{th}}$ level of the building for the fixed base condition when vibrating in its $m^{\text{th}}$ mode, Sec. 5.4.5.

---

$o$	Overstrength factor as defined in Table 5.2.2. Factor of safety in Chapter 8.
$\sum E_D$	Total energy dissipated, in kip-inches (kN-mm), in the isolation system during a full cycle of response at the design displacement, $D_D$ .
$\sum E_M$	Total energy dissipated, in kip-inches (kN-mm), on the isolation system during a full cycle of response at the maximum displacement, $D_M$ .
$\sum  F_D^+ _{max}$	Sum, for all isolator units, of the maximum absolute value of force, in kips (kN), at a positive displacement equal to $D_D$ .
$\sum  F_D^+ _{min}$	Sum, for all isolator units, of the minimum absolute value of force, in kips (kN), at a positive displacement equal to $D_D$ .
$\sum  F_D^- _{max}$	Sum, for all isolator units, of the maximum absolute value of force, in kips (kN), at a negative displacement equal to $D_D$ .
$\sum  F_D^- _{min}$	Sum, for all isolator units, of the minimum absolute value of force, in kips (kN), at a negative displacement equal to $D_D$ .
$\sum  F_M^+ _{max}$	Sum, for all isolator units, of the maximum absolute value of force, in kips (kN), at a positive displacement equal to $D_M$ .
$\sum  F_M^+ _{min}$	Sum, for all isolator units, of the minimum absolute value of force, in kips (kN), at a positive displacement equal to $D_M$ .
$\sum  F_M^- _{max}$	Sum, for all isolator units, of the maximum absolute value of force, in kips (kN), at a negative displacement equal to $D_M$ .
$\sum  F_M^- _{min}$	Sum, for all isolator units, of the minimum absolute value of force, in kips (kN), at a negative displacement equal to $D_M$ .

## Chapter 3 Commentary

### QUALITY ASSURANCE

**3.1 SCOPE:** Earthquake related failures of structures that are directly traceable to poor quality control during construction are innumerable. The literature containing earthquake damage is replete with reports indicating that the collapse of structures could have been prevented had proper quality assurance been exercised. The remarkable performance during earthquakes by California schools constructed since 1933 is due in great part to the rigorous supervision of the design and construction by the Office of the State Architect, as required by state law. The *Provisions* are written to rely heavily on the concept of quality controls to ensure good construction.

For structures located in areas of seismic risk, and subject to potential earthquake ground motion, good quality control and verification are especially important because of the serious consequences of failure and the unique, more complex, nature of the design and construction of buildings and structures when required to resist earthquake forces. The weakest components in the seismic-force-resisting systems are those affected by lateral forces. Generally, the failures of structures can be traced directly to a lack of quality control during design or construction, or both, when these components or details are slighted.

The registered design professional in responsible charge of the structure specifies the quality assurance requirements, the prime contractor exercises the control necessary to achieve the desired quality, and the owner monitors the construction process through special inspections and testing to protect the health, safety and welfare of the general public in built environment. Thus, the special inspector is the owner's inspector. It is essential that each party recognize their responsibilities, understand the procedures, and be capable of carrying them out. Because the contractor and the specialty subcontractors are performing the work and exercising control on quality, it is essential that the special inspections be performed by someone not in their direct employ and also be approved by the authority having jurisdiction. When the owner is also the contractor, the owner should engage independent agencies to conduct these special inspections rather than try to qualify his or her own employees.

These *Provisions* are concerned with those components that affect the performance of structures during an earthquake or structures that may be adversely affected by earthquake motions as specified in other sections of the *Provisions*. The requirements included in Chapter 3 are the minimum, and it could be the decision of the registered design professionals to include all phases of construction, throughout the project, under a quality assurance plan. For many structures, the additional cost to do so would be minimal. The primary method of achieving quality assurance is through the use of specially qualified inspectors approved by the authority having jurisdiction and working on behalf of the owner. The number of such inspectors actually employed will vary widely depending on the size, complexity, and function of the structure under construction. These *Provisions* allow the registered design professional or his or her employees to perform these special inspections, as long as the individuals are approved by the authority having jurisdiction, and they can demonstrate reasonable competence in the particular category of work they inspect.



**3.2 QUALITY ASSURANCE PLAN:** Introduced in this section is the concept that the quality assurance plan ) must be prepared by the registered design professional responsible for the design of each designated seismic system that is subject to quality assurance, whether it be architectural, electrical, mechanical, or structural in nature. The quality assurance plan may be a very simple listing of those elements of each system that have been designated as being important enough to receive special inspections and/or testing. The extent and duration of the inspections shall be set forth in the quality assurance plan, as well as the specific tests and the frequency of testing that is required.

Although some registered design professionals have expressed reluctance to accept the responsibility for the quality assurance plan, because of an assumed increase in potential liability, it has been demonstrated by the performance of schools in California that have been subjected to earthquakes, that the improved quality also acts to protect the registered design professional. Furthermore, the registered design professional is the most qualified person to prepare the quality assurance plan since the registered design professional is the most familiar with the design of the structure.

The authority having jurisdiction, however, must approve the quality assurance plan and must obtain from each contractor a written statement that the contractor understands the requirements of the quality assurance plan and will exercise the necessary control to obtain conformance. The exact methods of control are the responsibility of the individual contractors, subject to approval by the authority having jurisdiction. However, special inspections of the work are required in specific situations to provide the authority having jurisdiction reasonable assurance that there is compliance with the approved construction documents.

The exception to the preparation of a quality assurance plan is intended for those structures constructed of light wood framing and light gauge cold-formed steel framing with a height not greater than 35 feet above grade that are located in areas of low seismic risk ( $S_{DS}$  does not exceed 0.50g) and that satisfy all of the criteria indicated, or those structures constructed of reinforced masonry not more than 25 feet above grade that are located in areas of low seismic risk ( $S_{DS}$  does not exceed 0.50g), and that satisfy all of the criteria indicated. All special inspection(s) and testing that are otherwise required by the *Provisions* are not exempt and must be performed in accordance with the applicable sections of the *Provisions*.

The exception will typically include structures for low-rise multifamily dwellings, commercial, mercantile, and office buildings that are included in Seismic Use Group I. The exception is also limited to those structures that do not have any of the following irregularities: torsional irregularity, extreme torsional irregularity, nonparallel systems, stiffness irregularity (soft story), stiffness irregularity (extreme soft story), or discontinuity in capacity (weak story). Any structure that does not satisfy all of the criteria included in the exception or is otherwise exempted by the *Provisions* is required to have a quality assurance plan prepared by a registered design professional. It is important to emphasize that this exception is for the preparation of a quality assurance plan, and is not an exception for the design of the structure in accordance with the requirements of the *Provisions*.

The extent of the qualifications of the contractor and subcontractors can vary considerably, hence the extent of the quality control can vary considerably. The quality assurance plan, therefore, is an

opportunity to identify those areas of special concern that must be addressed during the construction process. Those areas include but are not limited to types of testing, frequency of testing, types of inspections, frequency of inspections, and the extent of the structural observations to be performed.

**3.3 SPECIAL INSPECTIONS:** The requirements listed in this section, from foundation systems through cold formed steel framing, have been included in the national model codes for many years, and it is a premise of these *Provisions* that there will be available an adequate supply of knowledgeable and experienced inspectors to provide the necessary special inspections for the various structural categories of work. Special training programs may have to be developed and implemented for the nonstructural categories.

A special inspector is a person approved by the authority having jurisdiction as being qualified to perform special inspections for the category of work involved. As a guide to the authority having jurisdiction, it is contemplated that the special inspector is to be one of the following:

1. A person employed and supervised by the registered design professional in responsible charge for the design of the designated seismic system or the seismic-force-resisting system for which the special inspector is engaged.
2. A person employed by an approved inspection and/or testing agency who is under the direct supervision of a registered design professional also employed by the same agency, using inspectors or technicians qualified by recognized industry organizations as approved by the authority having jurisdiction.
3. A manufacturer or fabricator of components, equipment, or machinery that has been approved for manufacturing components that satisfy seismic safety standards and that maintains a quality assurance plan approved by the authority having jurisdiction. The manufacturer or fabricator is required to provide evidence of such approval by clearly marked on each designated seismic system or seismic-force-resisting system component shipped to the construction site.

The extent and duration of special inspections, types of testing, and the frequency of the testing must be clearly delineated in the quality assurance plan.

**3.3.9 Architectural Components:** It is anticipated that the minimum requirements for architectural components will be complied with when the special inspector is satisfied that the method of anchoring or fastening and the number, spacing, and types of fasteners actually used conforms with the approved construction documents for the component installed. It is noted that such special inspection requirements are only for those components in Seismic Design Categories D or E.

**3.3.10 Mechanical and Electrical Components:** It is anticipated that the minimum requirements for mechanical and electrical components will be complied with when the special inspector is satisfied that the method of anchoring or fastening and the number, spacing, and types of fasteners actually used conforms with the approved construction documents for the component installed. It is noted that such special inspection requirements are for selected electrical, lighting, piping, and ductwork components in all Seismic Design Categories except A, and for all other electrical equipment in Seismic Design Categories E and F.

**3.4 TESTING:** The specified testing of the structural materials follows procedures and tests long established by industry standards. The acceptance criteria for each material to be tested should be included in the construction documents prepared for the project.

**3.4.5 Mechanical and Electrical Equipment:** The registered design professional should consider requirements to demonstrate the seismic performance of mechanical and electrical components critical to the post-earthquake life safety of the occupants. Any requirements should be clearly indicated on the construction documents. Any currently accepted technology should be acceptable to demonstrate compliance with the requirements.

**3.5 STRUCTURAL OBSERVATIONS:** The requirements included in this section are for the structural observation of those structures included in Seismic Design Categories D, E, or F when one or more of the following conditions exists: the structure is included in Seismic Use Group I or Seismic Use Group II or the structure is more than 75 feet above grade. The intent of requiring structural observations by a registered design professional for the aforementioned structures is to assure that the seismic-force-resisting systems and the designated seismic systems are constructed in general conformance with the construction documents.

**3.6 REPORTING AND COMPLIANCE PROCEDURES:** The success of a quality assurance plan depends upon the experience, training, and knowledge of the special inspector and the accuracy and thoroughness of the reports prepared by the special inspector. It should be emphasized that both the special inspector and the contractor are required to submit to the authority having jurisdiction a final certification that the completed work is in conformance with the approved construction documents. The contractor, having day-to-day knowledge of the construction of the project, is in the best position to state whether or not all the construction has been completed in accordance with the approved construction documents. To be fully aware, however, the contractor must institute a system of reporting within his or her organization that enables the contractor to effectively practice quality control. The special inspector can only attest to the work that he or she has personally inspected and, therefore, the special inspector acts more as an auditor or monitor of the quality control program exercised by the contractor and the testing conducted by the testing agency.

Continuous inspection does not imply that the special inspector has observed all of the work as it is being installed, rather it implies that the special inspector has observed all of the critical conditions of the work to be sufficiently confident that the work was completed in conformance with the construction documents.

## Chapter 4 Commentary

### GROUND MOTION

#### **4.1 DETERMINING MAXIMUM CONSIDERED EARTHQUAKE AND DESIGN EARTHQUAKE GROUND MOTION ACCELERATIONS AND RESPONSE SPECTRA:**

This section sets alternative procedures for determining ground shaking parameters for use in the design process. The design requirements generally use response spectra to represent ground motions in the design process. For the purposes of these *Provisions*, these spectra are permitted to be determined using either a generalized procedure in which mapped seismic response acceleration parameters are referred to or by site-specific procedures. The generalized procedure in which mapped values are used is described in Sec. 4.1.2. The site-specific procedure is described in Sec. 4.1.3.

**4.1.1 Maximum Considered Earthquake Ground Motions:** The *Provisions* are intended to provide uniform levels of performance for structures, depending on their occupancy and use and the risk to society inherent in their failure. Sec. 1.3 of the *Provisions* establishes a series of Seismic Use Groups that are used to categorize structures based on the specific Seismic Design Category. It is the intent of these *Provisions* that a uniform margin of failure to meet the seismic design criteria be provided for all structures within a given Seismic Use Group.

In past editions of the *Provisions*, seismic hazards around the nation were defined at a uniform 10 percent probability of exceedance in 50 years and the design requirements were based on assigning a structure to a Seismic Hazard Exposure Group and a Seismic Performance Category. While this approach provided for a uniform likelihood throughout the nation that the design ground motion would not be exceeded, it did not provide for a uniform margin of failure for structures designed for that ground motion. The reason for this is that the rate of change of earthquake ground motion versus likelihood is not constant in different regions of the United States.

The approach adopted in these *Provisions* is intended to provide for a uniform margin against collapse at the design ground motion. In order to accomplish this, ground motion hazards are defined in terms of maximum considered earthquake ground motions. The maximum considered earthquake ground motions are based on a set of rules that depend on the seismicity of an individual region. The design ground motions are based on a lower bound estimate of the margin against collapse inherent in structures designed to the *Provisions*. This lower bound was judged, based on experience, to be about a factor of 1.5 in ground motion. Consequently, the design earthquake ground motion was selected at a ground shaking level that is 1/1.5 (2/3) of the maximum considered earthquake ground motion.

For most regions of the nation, the maximum considered earthquake ground motion is defined with a uniform likelihood of exceedance of 2 percent in 50 years (return period of about 2500 years). While stronger shaking than this could occur, it was judged that it would be economically impractical to design for such very rare ground motions and the selection of the

2 percent in 50 years likelihood as the maximum considered earthquake ground motion would result in acceptable levels of seismic safety for the nation.

In regions of high seismicity, such as coastal California, the seismic hazard is typically controlled by large-magnitude events occurring on a limited number of well defined fault systems. Ground shaking calculated at a 2 percent in 50 years likelihood would be much larger than that which would be expected based on the characteristic magnitudes of earthquakes on these known active faults. This is because these major active faults can produce characteristic earthquakes every few hundred years. For these regions, it is considered more appropriate to directly determine maximum considered earthquake ground motions based on the characteristic earthquakes of these defined faults. In order to provide for an appropriate level of conservatism in the design process, when this approach to calculation of the maximum considered earthquake ground motion is used, the median estimate of ground motion resulting for the characteristic event is multiplied by 1.5.

Sec. 4.1.1 of the *Provisions* defines the maximum considered earthquake ground motion in terms of the mapped values of the spectral response acceleration at short periods,  $S_s$ , and at 1 second,  $S_1$ , for Site Class B sites. These values may be obtained directly from Maps 1 through 24, respectively. A detailed explanation for the development of Maps 1 through 24 appears as Appendix A of this *Commentary* volume. The logic by which these maps were created, as described above and in Appendix A, is also included in the *Provisions* under Sec 4.1.3, Site-Specific Procedures, so that registered design professionals performing such a study may use methods consistent with those that served as the basis for developing the maps.

**4.1.2 General Procedure for Determining Maximum Considered Earthquake Ground Motions and Design Spectral Response Accelerations:** This section provides the procedure for obtaining design site spectral response accelerations using the maps provided with the *Provisions*. Most buildings and structures will be designed using the equivalent lateral force technique of Sec. 5.3, and this general procedure to determine the design spectral response acceleration parameters,  $S_{DS}$  and  $S_{D1}$ , that are directly used in that procedure. Some structures will be designed using the modal analysis procedures of Sec. 5.4. This section also provides for the development of a general response spectrum, which may be used directly in the modal analysis procedure, from the design spectral response acceleration parameters,  $S_{DS}$  and  $S_{D1}$ .

Maps 1 and 2 respectively provide two parameters  $S_s$  and  $S_1$ , based on a national seismic hazard study conducted by the U.S. Geological Survey. For most buildings and sites, they provide a suitably accurate estimate of the maximum considered earthquake ground shaking for design purposes. For some sites, with special soil conditions or for some buildings with special design requirements, it may be more appropriate to determine a site specific estimate of the maximum considered earthquake ground shaking response accelerations. Section 4.1.3 provides guidance on site-specific procedures.

$S_s$  is the mapped value, from Map 1 of the 5% damped maximum considered earthquake spectral response acceleration, for short period structures founded on Class B, firm rock, sites. The short period acceleration has been determined at a period 0.2 seconds. This is because it was concluded that 0.2 seconds was reasonably representative of the shortest effective period of buildings and

structures that are designed by these *Provisions*, considering the effects of soil compliance, foundation rocking and other factors typically neglected in structural analysis.

Similarly,  $S_I$  is the mapped value from Map 2 of the 5% damped maximum considered earthquake spectral response acceleration at a period of 1 second on Site Class B. The spectral response acceleration at periods other than 1 second can typically be derived from the acceleration at 1 second. Consequently, these two response acceleration parameters,  $S_S$  and  $S_I$ , are sufficient to define an entire response spectrum for the period range of importance for most buildings and structures, for maximum considered earthquake ground shaking on Class B sites.

In order to obtain acceleration response parameters that are appropriate for sites with other characteristics, it is necessary to modify the  $S_S$  and  $S_I$  values, as indicated in Sec.4.1.2.4. This modification is performed with the use of two coefficients,  $F_a$  and  $F_v$  which respectively scale the  $S_S$  and  $S_I$  values determined for firm rock sites to appropriate values for other site conditions. The maximum considered earthquake spectral response accelerations adjusted for Site Class effects are designated respectively,  $S_{MS}$  and  $S_{MI}$ , for short period and 1 second period response. As described above, structural design in these *Provisions* is performed for earthquake demands that are 2/3 of the maximum considered earthquake response spectra. Two additional parameters,  $S_{DS}$  and  $S_{DI}$  are used to define the acceleration response spectrum for this design level event. These are taken, respectively as 2/3 of the maximum considered earthquake values  $S_{MS}$  and  $S_{MI}$ , and completely define a design response spectrum for sites of any characteristics.

Section 4.1.2.1 provides a categorization of the various classes of site conditions, as they affect the design response acceleration parameters. Section 4.1.2.2 describes the method by which sites can be classified according as belonging to one of these Site Classes. Section 4.1.2.3 provides definitions of some site parameters referenced in the preceding section.

**4.1.2.1 Site Class Definitions:** It has long been recognized that the effects of local soil conditions on ground motion characteristics should be considered in building design, and most countries considering these effects have developed different design criteria for several different soil conditions. The 1989 Loma Prieta earthquake provided abundant strong motion data that was used extensively together with other information in developing the 1994 *Provisions*. Evidence of the effects of local soil conditions has been observed globally including eastern North America. An example of the latter is a pocket of high intensity reported on soft soils in Shawinigan, Quebec, approximately 155 miles (250 km) from the 1925 Charlevoix magnitude 7 earthquake (Milne and Davenport, 1969).

The Applied Technology Council (ATC) study that generated the preliminary version of the *Provisions* provided for the use of three Soil Profile Types considered, in the late 1970s, to be different enough in seismic response to warrant separate site coefficients ( $S$  factors) and experience from the September 1985 Mexico City earthquake prompted the addition of a fourth Soil Profile Type. These have been revised for the 1994 *Provisions* to conform to the experiences of the Mexico City and the 1989 Loma Prieta earthquake in California as well as to other observations and studies showing the effects of level of shaking, rock stiffness, and soil type, stiffness and depth on the amplification of ground motions at short and long periods. The resulting use of higher seismic coefficients in areas of lower shaking and the addition of a "hard rock" category in the 1994 *Provisions* better reflect the conditions in some parts of the country

and incorporate recent efforts toward a seismic code for New York City (Jacob, 1990 and 1991). The need for improvement in codifying site effects was discussed at a 1991 National Center for Earthquake Engineering Research (NCEER) workshop devoted to the subject (Whitman, 1992), which made several general recommendations. At the urging of Robert V. Whitman, a committee was formed during that workshop to pursue resolution of pending issues and develop specific code recommendations. Serving on this committee were M. S. Power (chairman), R. D. Borcherdt, C. B. Crouse, R. Dobry, I. M. Idriss, W. B. Joyner, G. R. Martin, E. E. Rinne, and R. B. Seed. The committee collected information, guided related research, discussed the issues, and organized a November 1992 Site Response Workshop in Los Angeles (Martin, 1994). This workshop discussed the results of a number of empirical and analytical studies and approved consensus recommendations that form the basis for the 1994 *Provisions*.

*Amplification of Peak Ground Acceleration:* Seed and coworkers (1976a) conducted a statistical study of peak accelerations developed at locations with different site conditions using 147 records from each western U.S. earthquake of about magnitude 6.5. Based on these results, judgment and analysis, they proposed the acceleration relations of Figure C4.1.2-1a that are applicable to any earthquake magnitude of engineering interest. It must be noted that the data base of that study did not include any soft clay sites and, thus, the corresponding curve in the figure was based on the authors' experience and, consequently, was somewhat more speculative.

Idriss (1990a and 1990b), using data from the 1985 Mexico City and 1989 Loma Prieta earthquakes, recently modified the curve for soft soil sites as shown in Figure C4.1.2-1b. In these earthquakes, low maximum rock accelerations of 0.05g to 0.10g were amplified by factors of from about 1.5 to 4 at sites containing soft clay layers ranging in thickness from a few feet to more than a hundred feet and having depths of rock up to several hundred feet. As shown by the data and site response calculations included in Figure C4.1.2-1b, the average amplification factor for soft soil sites tends to decrease as the rock acceleration increases--from 2.5 to 3 at low accelerations to about 1.0 for a rock acceleration of 0.4g. Since this effect is directly related to the nonlinear stress-strain behavior in the soil as the acceleration increases, the curve in Figure C4.1.2-1b can be applied in first approximation to any earthquake magnitude of engineering interest.

It is clear from Figure C4.1.2-1b that low peak accelerations can be amplified several times at soil sites, especially those containing soft layers and where the rock is not very deep. On the other hand, larger peak accelerations can be amplified to a lesser degree and can even be slightly deamplified at very high rock accelerations. In addition to peak rock acceleration, a number of factors including soil softness and layering play a role in the degree of amplification. One important factor is the impedance contrast between soil and underlying rock.

*Spectral Shapes:* Spectral shapes representative of the different soil conditions discussed above were selected on the basis of a statistical study of the spectral shapes developed on such soils close to the seismic source zone in past earthquakes (Seed et al., 1976a and 1976b; Hayashi et al., 1971).

The mean spectral shapes determined directly from the study by Seed and coworkers (1976b), based on 104 records from 21 earthquakes in the western part of the United States, Japan and Turkey, are shown in Figure C4.1.2-2. The ranges of magnitudes and peak accelerations covered

by this data base are 5.0 to 7.8 and 0.04g to 0.43g, respectively. All spectra used to generate the mean curve for soft to medium clay and sand in Figure C4.1.2-2 correspond to rather low peak accelerations in the soil (less than 0.10g). The spectral shapes in the figure also were compared with the studies of spectral shapes conducted by Newmark et al. (1973), Blume et al. (1973), and Mohraz (1976) and with studies for use in model building regulations. It was considered appropriate to simplify the form of the curves to a family of three by combining the spectra for rock and stiff soil conditions leading to the normalized spectral curves shown in Figure C4.1.2-3. The curves in this figure therefore apply to the three soil conditions in the original version (1985) of the *Provisions*.

The three conditions corresponding to the three lines in Figure C4.1.3-3 plus a fourth condition introduced following the 1985 Mexico City earthquake are described as follows:

1. Soil Profile Type  $S_1$ --A soil profile with either: (1) rock of any characteristic, either shale-like or crystalline in nature, that has a shear wave velocity greater than 2,500 ft/s (762 m/s) or (2) stiff soil conditions where the soil depth is less than 200 ft (61 m) and the soil types overlying the rock are stable deposits of sands, gravels, or stiff clays.
2. Soil Profile Type  $S_2$ --A soil profile with deep cohesionless or stiff clay conditions where the soil depth exceeds 200 ft (61 m) and the soil types overlying rock are stable deposits of sands, gravels, or stiff clays.
3. Soil Profile Type  $S_3$ --A soil profile containing 20 to 40 ft (6 to 12 m) in thickness of soft- to medium-stiff clays with or without intervening layers of cohesionless soils.
4. Soil Profile Type  $S_4$ --A soil profile characterized by a shear wave velocity of less than 500 ft/sec (152 m/s) containing more than 40 ft (12 m) of soft clays or silts.

The post-Loma Prieta studies (Martin, 1994) have resulted in considerable modification of these profile types resulting in the Soil Profile Types in the 1994 *Provisions*, A through F.

*Response of Soft Sites to Low Rock Accelerations:* Earthquake records on soft to medium clay sites subjected to low acceleration levels indicate that the soil/rock amplification factors for long-period spectral accelerations can be significantly larger than those in Figures C4.1.2-1 and C4.1.2-2 (Seed et al., 1974). Furthermore, the largest amplification often occurs at the natural period of the soil deposit. In Mexico City in 1985, the maximum rock acceleration was amplified four times by a soft clay deposit that would have been classified as  $S_4$  whereas the spectral amplitudes were about 15 to 20 times larger than on rock at a period near 2 sec. In other parts of the valley where the clay is thicker, the spectral amplitudes at periods ranging between 3 and 4 sec also were amplified about 15 times, but the damage was less due to the low rock motion intensity at these very long periods (Seed et al., 1988). Inspection of the records obtained at some soft clay sites during the 1989 Loma Prieta earthquake indicates a maximum amplification of long-period spectral amplitudes of the order of three to six times.

Figure C4.1.2-4 shows a comparison of average response spectra measured on rock and soft soil sites in San Francisco and Oakland during this magnitude 7.1 earthquake. A preliminary study of the Loma Prieta records at one 285-ft (87 m) soil deposit on rock containing a 55-ft (17 m) soft to medium stiff clay layer (Treasure Island) seems to suggest that the largest soil/rock



amplification of response spectra occurred at the natural period of the soil deposit, similarly to Mexico City (Seed et al., 1990).

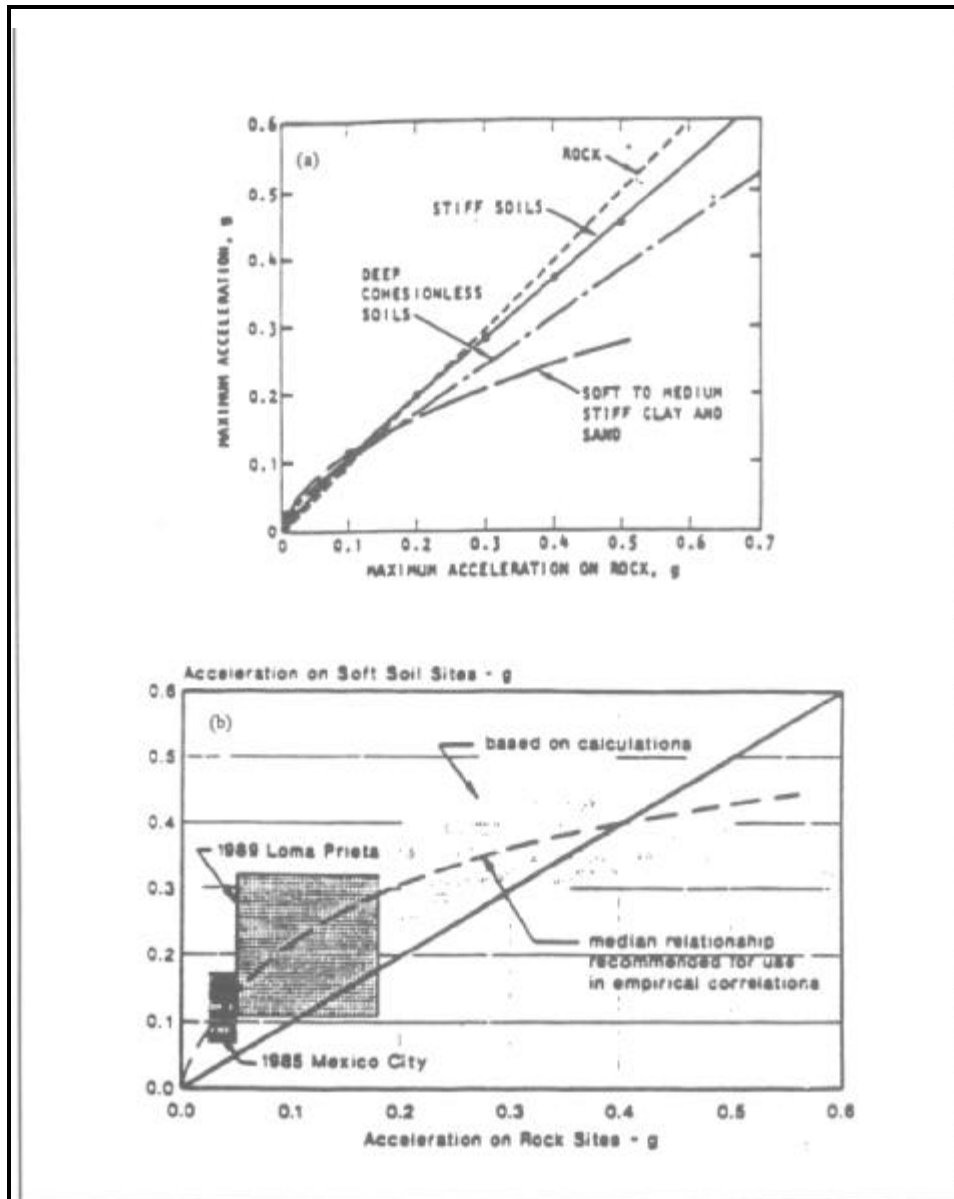

FIGURE C4.1.2-1 Relationships between maximum acceleration on rock and other local site conditions: (top) Seed et al., 1976a, and (bottom) Idriss, 1990a and 1990b.

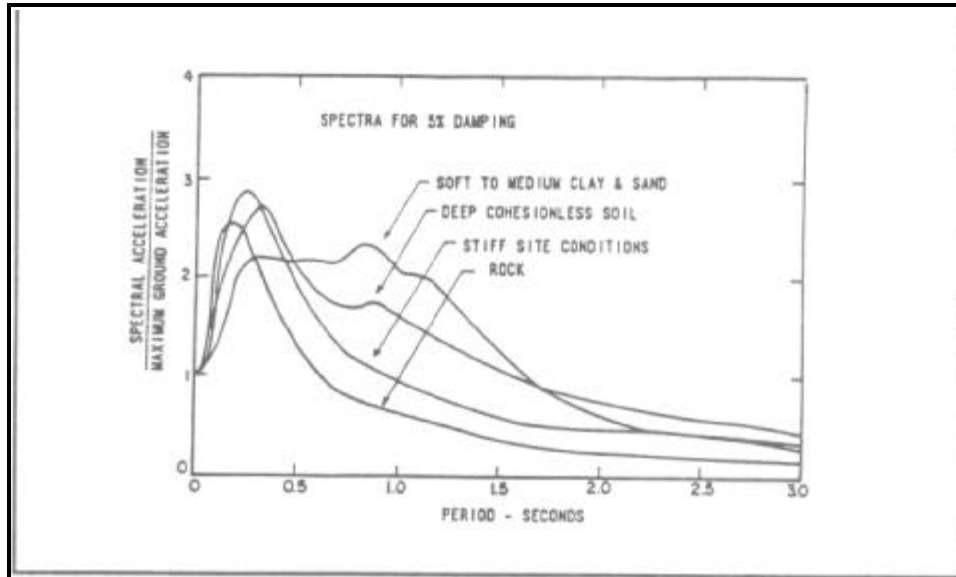

FIGURE C4.1.2-2 Average acceleration spectra for different site conditions (Seed et al., 1976a and 1976b).

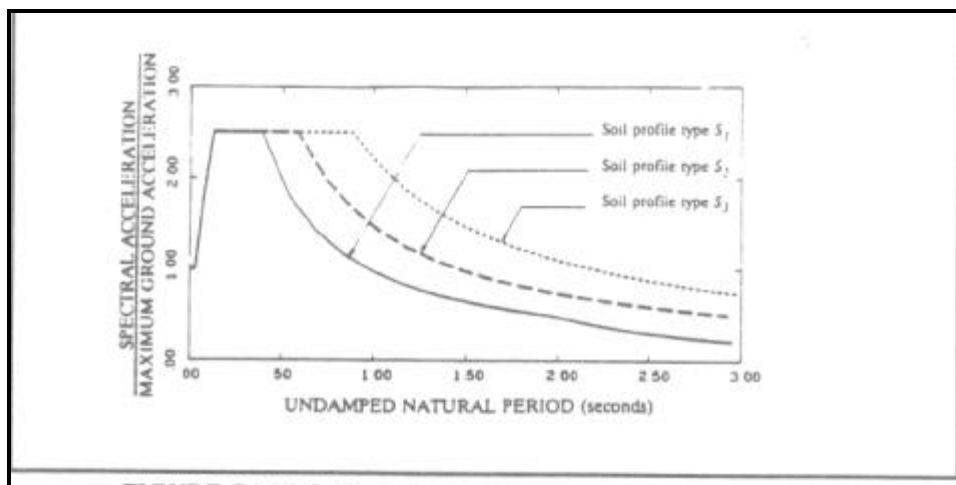

FIGURE C4.1.2-3 Normalized response spectra, damping = 0.05.

Some relevant theoretical and experimental findings are reviewed briefly below to clarify the role of key site parameters in determining the magnitude of the soil/rock amplification of spectral ordinates at long periods for sites containing soft layers. These parameters are the thickness of the soft soil, the shear wave velocity of the soft soil, the soil/rock impedance ratio ( $IR$ ), the layering and properties of the stiffer soil between soft layer and rock, and the modulus and damping properties of the soft soil. The basic assumptions used are those typically used in one-dimensional site response analyses and, thus, the conclusions drawn are restricted to sites where these conditions are fulfilled (i.e., flat sites with horizontal layering of significant extension and far from rock outcrops and with a clear soil-rock interface at a depth not exceeding several hundred feet).

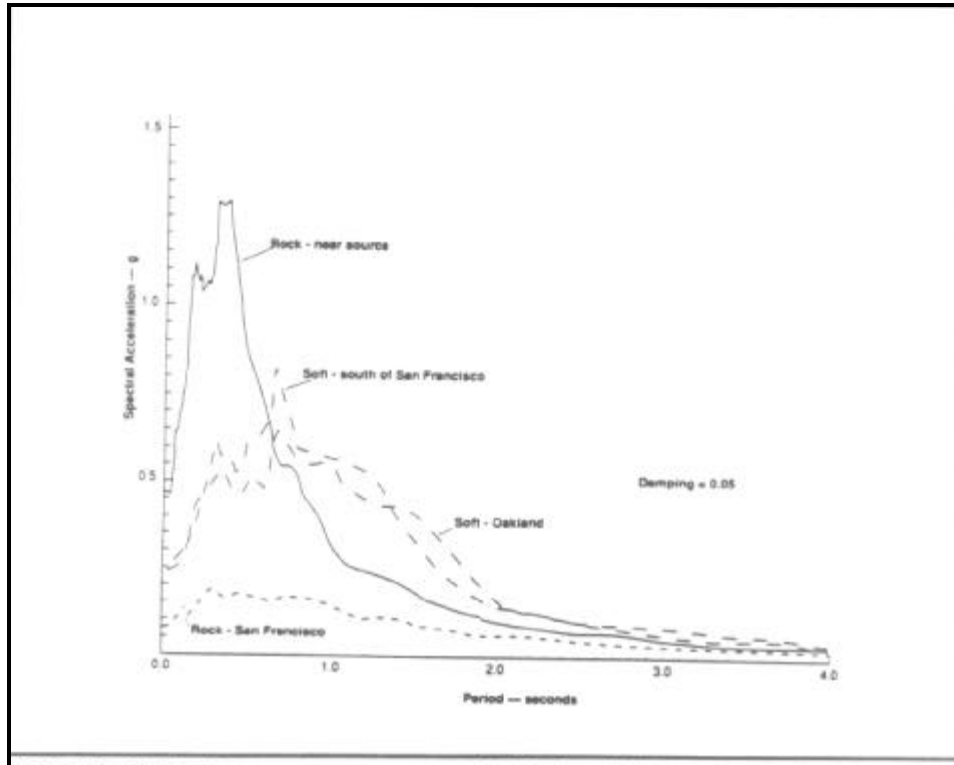

FIGURE C4.4.2-4 Average spectra recorded during 1989 Loma Prieta earthquake at rock sites and soft soil sites (Housner, 1990).

The uniform layer on elastic rock sketched in Figure C4.1.2-5 is subjected to a vertically propagating shear wave representing the earthquake. The soil layer is assumed to behave linearly and it has a thickness  $h$ , total (saturated) unit weight  $\gamma_s$ , shear wave velocity  $v_s$ , and internal damping ratio  $b_s$ . The rock has total unit weight  $\gamma_r$ , shear wave velocity  $v_r$ , and zero damping.

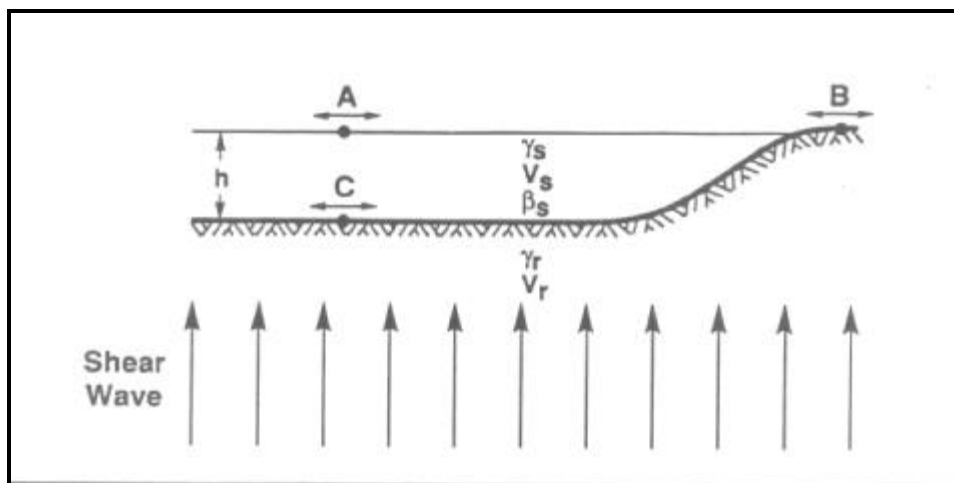

FIGURE C4.1.2-5 Uniform soil layer on elastic rock subjected to vertical shear waves.

Due to the soil-rock interaction effect, the motion at the soil-rock interface C is different (typically less) from that at the rock outcrop B. Only if the rock is rigid ( $v_s = \infty$ ) are the motions at C and B equal. Of interest here is the ratio between the motions on top of the soil (point A) and on the rock outcrop (point B).

When the acceleration at B is a harmonic motion of frequency  $f$  (cps) and amplitude  $a_B$ , the acceleration at A is also harmonic of the same frequency and amplitude  $a_A$ . The amplification ratio  $a_A/a_B$  is a function of the ratio of frequencies  $f/(v_s/4h)$ , of the soil damping  $b_s$ , and of the rock/soil impedance ratio which is equal to  $g_r v_r / g_s v_s$ . Figure C4.1.2-6 presents  $a_A/a_B$  calculated for a layer with  $h = 100$  ft (30.5 m),  $v_s/4h = 1.88$  cps, and  $IR = 6.7$  (Roesset, 1977). The maximum amplification occurs essentially at the natural frequency of the layer,  $f_{soil} = V_s/4h$ , and is approximately equal to:

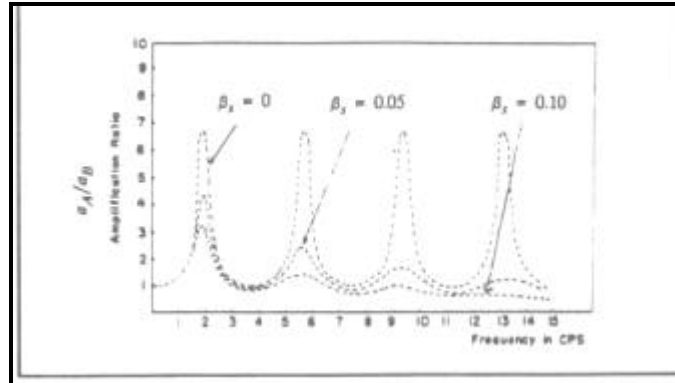

FIGURE C4.1.2-6 Amplification ratio soil/rock for  $h = 100$  ft (30.5 m),  $V_s = 1.88$  cps, and  $IR = 6.7$  (Roesset, 1977).

$$\left( \frac{a_A}{a_B} \right)_{\max} = \frac{I}{\left( \frac{1}{IR} \right) + \left( \frac{2}{b_s} \right)} \quad (C4.1.2-1)$$

That is, the maximum soil/rock amplification for steady-state harmonic motion in this simple model depends on two factors-- $b_s$  and  $IR$ . When  $IR = \infty$  (rigid rock), the only way the system can dissipate energy is in the soil and  $(a_A/a_B)_{\max} = 2/pb_s$  can be very large. For example, if  $IR = \infty$  and  $b_s = 0.04$ ,  $(a_A/a_B)_{\max} = 16$ . If  $IR$  decreases, the amplification  $(a_A/a_B)_{\max}$  also decreases. For example, if  $IR = 15$  and  $b_s = 0.04$ , the amplification is cut in half,  $(a_A/a_B)_{\max} = 8$ .

Another way of expressing the contribution of the impedance ratio  $IR$  in Eq. C4.1.2-1 is as an "additional equivalent soil damping" with a total damping  $b_{tot}$  in the system at its natural frequency:

$$b_{tot} \approx b_s + \left( \frac{2}{IR} \right) \quad (C4.1.2-2)$$

Eq. C4.1.2-2 is very important since the maximum amplification  $(a_A/a_B)_{\max}$  is always inversely proportional to  $b_{tot}$ , not only for the case of the uniform layer but also for other soil profiles on rock.  $b_{tot}$  always includes an internal damping contribution ( $b_s$ ) and a second term reflecting the rock-soil impedance contrast  $IR$  although the specific definition of  $IR$  and the numerical factor  $2/p$  generally will change depending on the profile. When a soft layer lies on top of a significant

thickness of stiffer soil followed by rock, Eq. C4.1.2-2 is still qualitatively valid, but the calculations are more complicated. In that case, the impedance contrast must consider the whole soil profile and, thus, both soft and stiff soils play a role in determining  $b_{tot}$  and  $(a_A/a_B)_{max}$ . Also, the maximum amplification may occur at the natural frequency of the soft layer, of the whole profile, or at some other frequency.

*Two-Factor Approach and the 1992 Site Response Workshop:* The recommendations developed during the NCEER/SEAOC/BSSC Site Response Workshop mentioned above were summarized by Rinne and Dobry (1992) and are reprinted as Appendix F of this commentary to provide the reader with a better understanding of the thinking behind the current *Provisions*. Some additional background information taken mostly from the proceedings of that workshop (Martin, 1994) is included below.

As discussed above, soil sites generally amplify more the rock spectral accelerations at long periods than at short periods and, for a severe level of shaking ( $S_S \gg 1.0g$ ;  $S_I \gg 0.4g$ ), the short-period amplification or deamplification is small; this was the basis for the use in the previous versions of the *Provisions*. However, the evidence that short-period accelerations including the peak acceleration can be amplified several times, especially at soft sites subjected to low levels of shaking, suggested the replacement of the normalized spectrum approach by the two-factor approach sketched in Figure C4.1.2-7. In this approach, adopted in the 1994 *Provisions*, the short-period plateau, represented by  $S_{MS}$ , is multiplied by a short-period site coefficient  $F_a$  and the long period curve represented by  $S_M/T$  is multiplied by a long-period site coefficient  $F_v$ . Both  $F_a$  and  $F_v$  depend on the site conditions and on the level of shaking, defined respectively by the values of  $S_S$  and  $S_I$ .

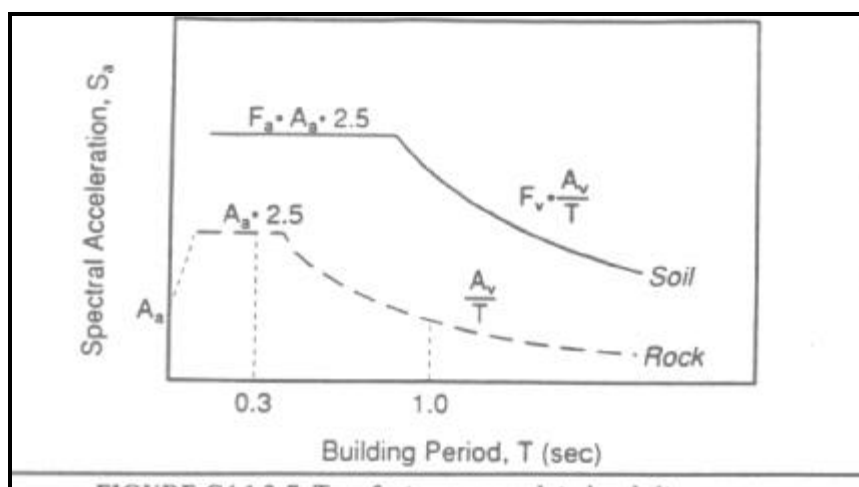
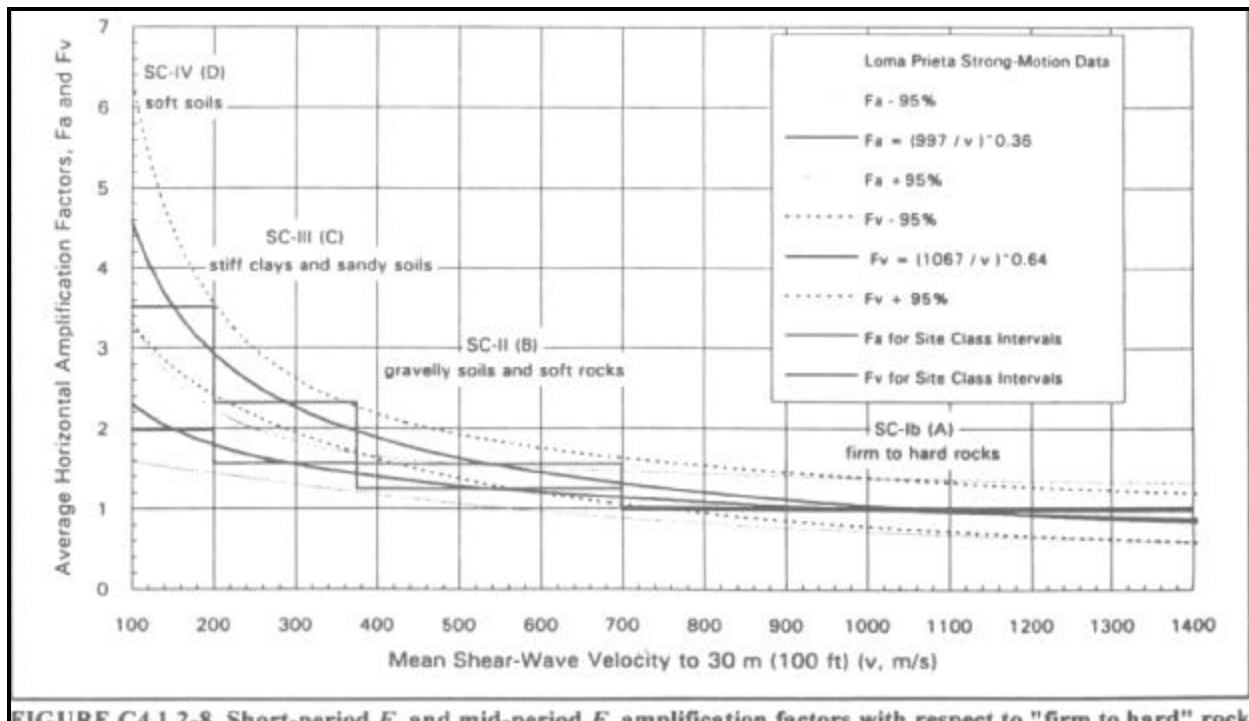

FIGURE C4.1.2-7 Two-factor approach to local site response.

Strong-motion recordings, as obtained from the Loma Prieta earthquake of October 17, 1989, provide important quantitative measures of the *in situ* response of a variety of geologic deposits to damaging levels of shaking. Average amplification factors derived from these data with respect to "firm to hard rock" for short-period (0.1-0.5 sec), intermediate-period (0.5-1.5 sec), mid-period (0.4-2.0 sec), and long-period (1.5-5.0 sec) bands show that a short- and mid-period factor

are sufficient to characterize the response of the local site conditions (Borcherdt, 1994). This important result is consistent with the two-factor approach summarized in Figure C4.1.2-7. Empirical regression curves fit to these amplification data as a function of mean shear wave velocity at the site are shown in Figure C4.1.2-8.

These curves provide empirical estimates of the site coefficients  $F_a$  and  $F_v$  as a function of mean shear wave velocity for input ground motion levels near 0.1g (Borcherdt and Glassmoyer, 1993). The empirical amplification factors predicted by these curves are in good agreement with those derived independently based on numerical modeling of the Loma Prieta strong-motion data (Seed et al., 1992) and those derived from parametric studies of several hundred soil profiles (Dobry et al., 1994b). These empirical relations are consistent with theory in that they imply that the average amplification at a site increases as the rock/soil impedance ratio (IR) increases, similar to the trend described by Eq. C4.1.2-1. They also are consistent with observed correlations between amplification and shear velocity for soft clays in Mexico City (Ordaz and Arciniegas, 1992). These short- and mid-period amplification factors implied by the Loma Prieta strong-motion data and related calculations for the same earthquake by Joyner et al. (1994) as well as modeling results at the 0.1g level provided the basis for the consensus values provided in Tables 4.1.2a and 4.1.2b. Values at higher levels were initially determined from modeling results for soft clays derived by Seed (1994) with values for intermediate soil conditions derived by linear extrapolation. A rigorous framework for extrapolation of the Loma Prieta results consistent with the results in Tables C4.1.2a and C4.1.2b is given in the following paragraph.



**FIGURE C4.1.2-8** Short-period  $F_a$  and mid-period  $F_v$  amplification factors with respect to "firm to hard" rock plotted as a continuous function of mean shear wave velocity using the regression equations derived from the strong-motion recordings of the Loma Prieta earthquake. The 95 percent confidence intervals for the ordinate to the true population regression line and the amplification factors for the simplified site classes also are shown (Borcherdt, 1994).

Extrapolation of amplification estimates at the 0.1g level as derived from the Loma Prieta earthquake must necessarily be based on laboratory and theoretical modeling considerations because few or no strong-motion recordings have been obtained at higher levels of motion, especially on soft soil deposits. Resulting estimates should be consistent with other relations between large rock and soil motions and local site conditions as summarized in Figure C4.1.2-1. The form of the regression curve in Figure C4.1.2-8 suggests a simple and well defined procedure for extrapolation. It shows that the functional relationship between the logarithms of amplification and mean shear velocity is a straight line (Borcherdt, 1993). Consequently, as the amplification factor for "firm to hard" rock is necessarily unity, the extrapolation problem is determined by specification of the amplification factors at successively higher levels of motion for the soft-soil site class. For input ground motion levels near 0.1g, Borcherdt (1993) began with amplification levels specified by the empirical regression curves (Figure C4.1.2-8) for the Loma Prieta strong-motion data. Higher levels of motion were inferred from laboratory and numerical modeling results (Seed et al., 1992; Dobry et al., 1994a). The resulting short-period ( $F_a$ ) and mid-period ( $F_v$ ) site coefficients as a function of mean shear velocity ( $v_s$ -labeled  $v_s$  elsewhere in this *Commentary* and in the *Provisions*) and input ground motion level ( $I_a$ ) specified with respect to "firm to hard" rock are given in Figure C4.1.2-9 and plotted with logarithmic scales. These expressions state that the average amplification at a site is equal to the "rock-soil" impedance ratio raised to an exponent ( $ma$  or  $mv$ ). These exponents are defined as the slope of the straight line determined by the logarithms of the amplification factors and the shear velocities for the soft-soil and the "firm to hard" rock site classes at the specified input ground motion level (Borcherdt, 1993). The equations in Figure C4.1.2-9 provide a framework to illustrate a simple procedure for derivation of amplification factors that are in general agreement with the consensus values included in Tables 1.4.2.3a and 1.4.2.3b of the *Provisions*. However, the numbers in these tables of the *Provisions* are not necessarily identical to the equations' predictions due to other considerations discussed during the consensus process.

Extensive site response studies using both equivalent linear and nonlinear programs were conducted by several groups as listed by Rinne and Dobry (1992). The main objectives of these studies were to generalize the experience of well documented earthquakes such as Loma Prieta and Mexico City to a variety of site conditions and earthquake types and levels of shaking. Some results obtained by Dobry et al. (1994a) are reproduced in Figures C4.1.2-10 to C4.1.2-12.

Figure C4.1.2-10 presents values of peak amplification at long periods for soft sites (labeled  $RRS_{max}$  in the figure) calculated using the equivalent linear approach as a function of the plasticity index ( $PI$ ) of the soil, rock wave velocity  $v_r$ , and for weak and strong shaking. The effect of  $PI$  is due to the fact that soils with higher  $PI$  exhibit less stress-strain nonlinearity and a lower damping  $b_s$  (Vucetic and Dobry, 1991). For  $S_s A_a = 0.25g$ ,  $S_l = 0.1g$ ,  $v_r = 4,000$  ft/sec (1220 m/s) and  $PI = 50$ , roughly representative of Bay area soft sites in the Loma Prieta earthquake,  $RRS_{max} = 4.4$ , which coincides with the upper part of the range backfigured by Borcherdt from the records. Note the reduction of this value of  $RRS_{max}$  from 4.4 to about 3.3 when  $S_s = 1.0g$ ,  $S_l = 0.4g$  due to soil nonlinearity. Evidence such as this is used in the 1994 *Provisions* to extrapolate values of  $F_a$  and  $F_v$  at low levels of shaking--based on both analysis and observations--to high levels of shaking for which no observations on soft sites currently are available.

---

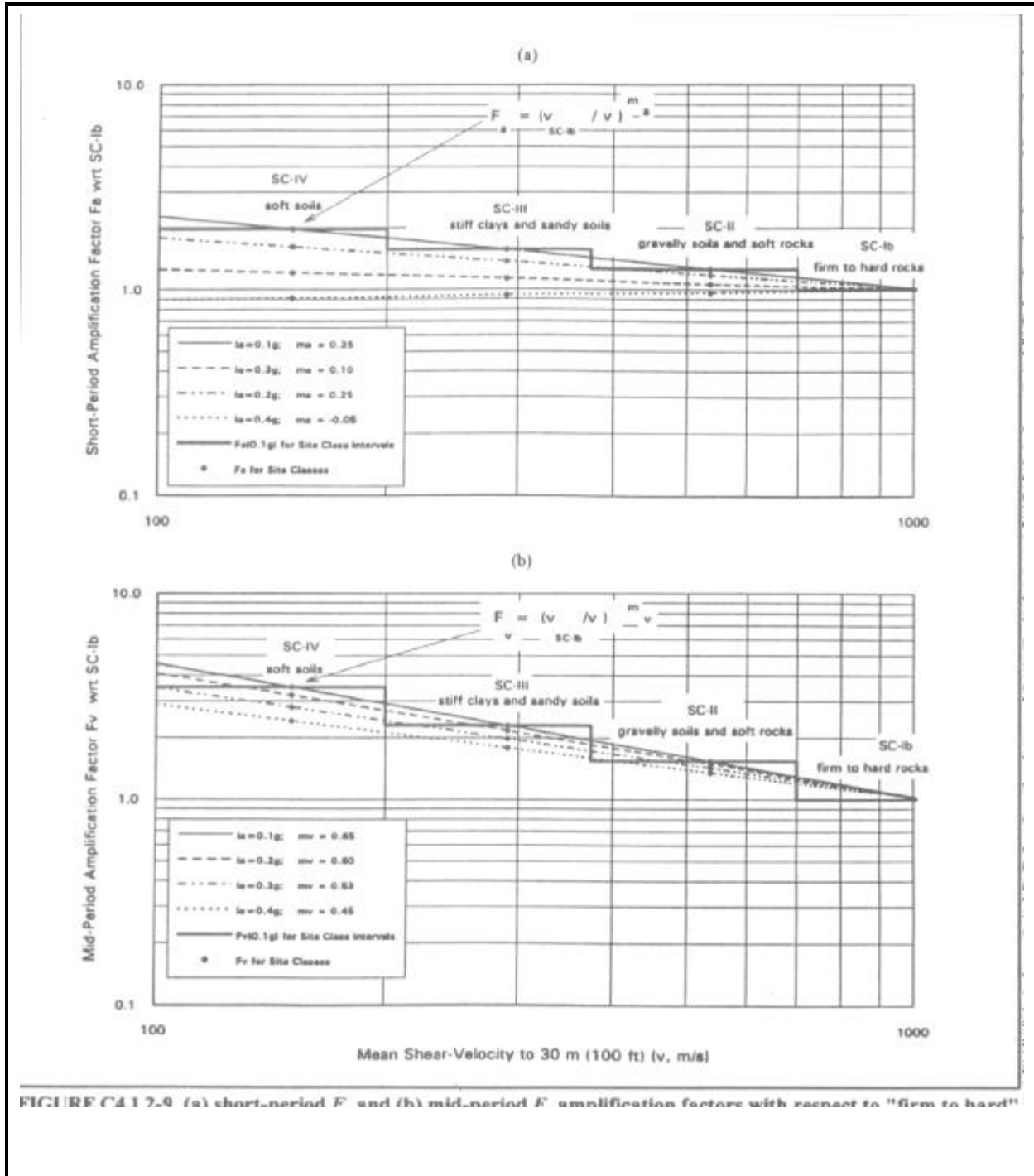

FIGURE C4.1.2-9 (a) short-period  $F_a$  and (b) mid-period  $F_v$  amplification factors with respect to "firm to hard" rock (SC-Ib) plotted with logarithmic scales as a continuous function of mean shear wave velocity using the indicated equations for specified levels of input ground motion. The equations correspond to straight lines determined by the points defined as the logarithms of the amplification factors and shear velocities for the "soft-soil" and "firm to hard" rock site classes. The amplification factors for the "soft-soil" site class are based on strong motion recordings at the 0.1g level and on numerical modeling and expert opinion results for higher levels of motion. The exponents  $m_a$  and  $m_v$  are given by the slope of the indicated straight lines. Amplification factors with respect to SC-Ib for the simplified site classes are shown for the corresponding mean shear wave velocity interval for input ground motion levels near 0.1g (Borcherdt, 1993).



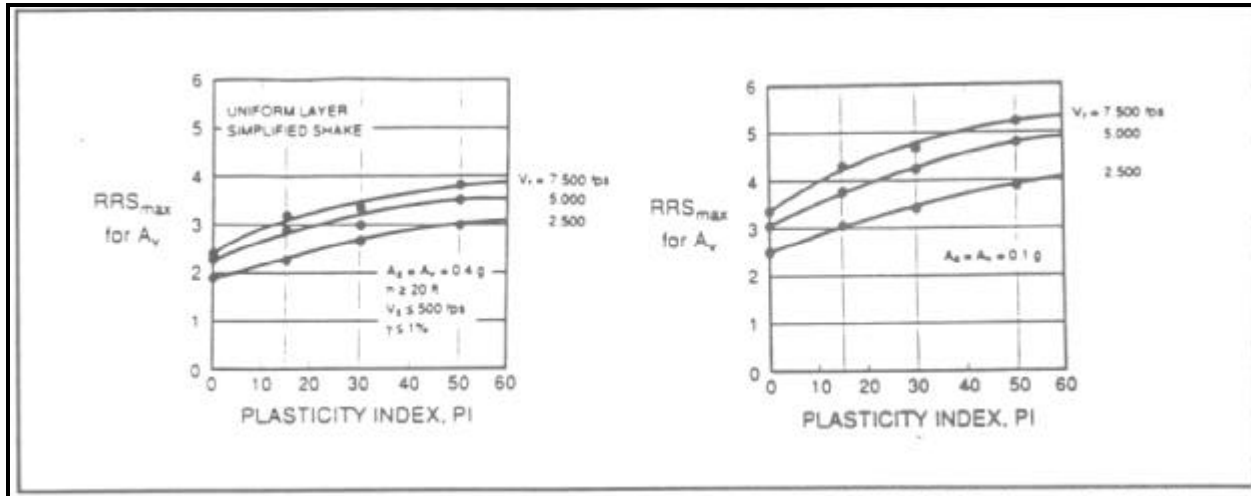

FIGURE C4.1.2-10 Summary of uniform layer analyses using simple SHAKE (Dobry et al., 1994a).

Specific equivalent linear runs using the SHAKE program corresponding to the same situation are included in Figure C4.1.2-11 while Figure C4.1.2-12 summarizes and compares them with calculations by Joyner et al. (1994) from the Loma Prieta records on soft sites similar to the work by Borcherdt mentioned above.

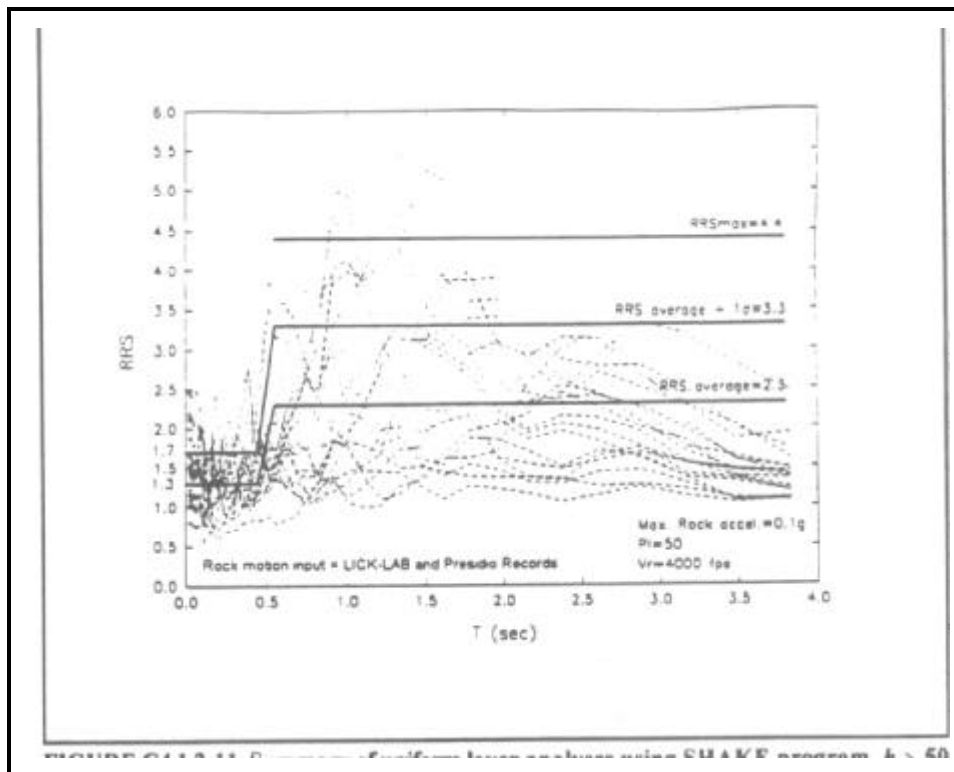

FIGURE C4.1.2-11 Summary of uniform layer analyses using SHAKE program,  $h = 50$  ft (15.2 m) (Dobry et al., 1994a).

Another important observation from analytical results such as shown in Figure C4.1.2-11 is that the values of  $RRS_{max}$  are about 20 percent higher for soft sites on "hard rock"--characterized by  $v_r = 7,500$  ft/sec (2290 m/s)--than for soft sites on "regular rock" corresponding to  $v_r = 4,000$  ft/sec (1220 m/s). This is again the impedance ratio effect previously discussed. Separate studies indicate that earthquake motions on outcrops of "hard rock" tend to be smaller than on outcrops of "regular rock" by 10 to 40 percent at both short and long periods (except at very small periods under about 0.2 sec where the reverse may be true); see Su et al. (1992) and Silva (1992). On the basis of these studies and observations, the 1994 *Provisions* incorporate the difference between "regular" rock (B) and "hard" rock of  $v_s > 5,000$  ft/sec (1520 m/s) by defining a new "hard rock" site category (A) and assigning to it site factors  $F_a = F_v = 0.8$ .

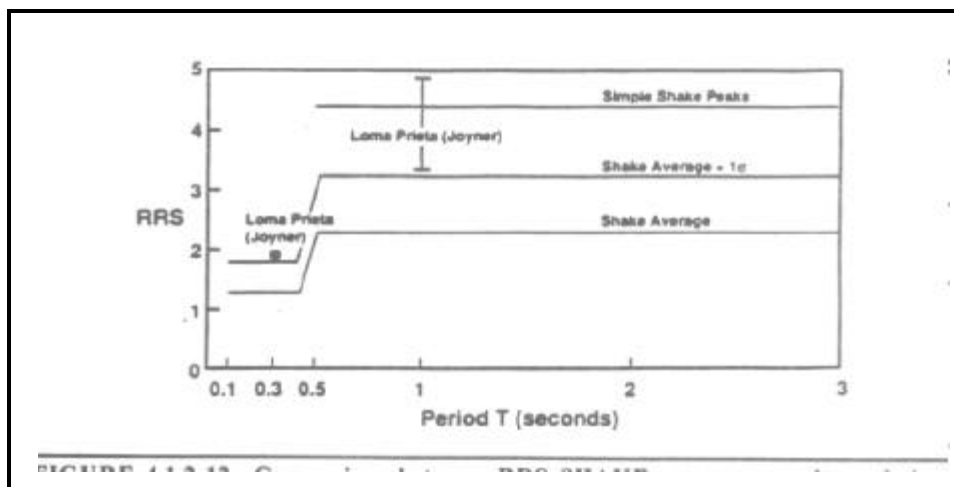

FIGURE 4.1.2-12 Comparison between RRS SHAKE program results and those obtained by Joyner et al. (1994) for the 1989 Loma Prieta event (Dobry et al., 1994a).

*Use of Geotechnical Parameters Instead of  $v_s$ :* Based on the studies and observations discussed above, the site categories in the 1994 *Provisions* are defined in terms of the average shear wave velocity in the top 100 ft (30.5 m) of the profile,  $v_s$ . If the shear wave velocities are available for the site, they should be used.

However, in recognition of the fact that in many cases the shear wave velocities are not available, alternative definitions of the site categories also are included in the 1994 *Provisions*. They use the standard penetration resistance for cohesionless soil layers and the undrained shear strength for cohesive soil layers. These alternative definitions are rather conservative since the correlation between site amplification and these geotechnical parameters is more uncertain than that with  $v_s$ . That is, there will be cases when the values of  $F_a$  and  $F_v$  will be smaller if the site category is based on  $v_s$  rather than on the geotechnical parameters. Also, the reader must not interpret the site category definitions as implying any specific numerical correlation between shear wave velocity on the one hand and standard penetration or shear strength on the other.

**4.1.2.5 General Procedure Design Response Spectrum:** This section provides a general method for obtaining a 5% damped response spectrum from the site design acceleration response

parameters  $S_{aS}$  and  $S_{aI}$ . This spectrum is based on that proposed by Newmark and Hall, as a series of three curves representing in the short period, a region of constant spectral response acceleration; in the long period a range of constant spectral response velocity; and in the very long period, a range of constant response spectral displacement. Response acceleration at any period in the long period range can be related to the constant response velocity by the equation:

$$S_a = S_v = \frac{2}{T} S_v \quad (\text{C4.1.2.5-1})$$

where  $\omega$  is the circular frequency of motion,  $T$  is the period and  $S_v$  is the constant spectral response velocity. The site design spectral response acceleration at 1 second,  $S_{aI}$ , therefore is simply related to the constant spectral velocity for the spectrum by the relation:

$$S_{aI} = 2 S_v \quad (\text{C4.1.2.5-2})$$

and the spectral response acceleration at any period in the constant velocity range can be obtained from the relationship:

$$S_a = \frac{S_{aI}}{T} \quad (\text{C4.1.2.5-3})$$

The constant displacement domain of the response spectrum is not included on the generalized response spectrum because relatively few structures have a period long enough to fall into this range. Response accelerations in the constant displacement domain can be related to the constant displacement by a  $1/T^2$  relationship. Section 5.4 of the *Provisions*, which provides the requirements for modal analysis also provides instructions for obtaining response accelerations in the very long period range.

**4.2 SEISMIC DESIGN CATEGORY:** This section establishes the five design categories that are the keys for establishing design requirements for any building based on its use (Seismic Use Group) and on the level of expected seismic ground motion. Once the Seismic Design Category (A, B, C, D, E, or F) for the building is established, many other requirements such as detailing, quality assurance, systems and height limitations, specialized requirements, and change of use are related to it.

In previous editions of the *Provisions*, these categories were termed Seismic Performance Categories. While the desired performance of the building, under the design earthquake, was one consideration used to determine which category a building should be assigned to, it was not the only factor. The seismic hazard at the site was actually the principle parameter that affected a building's category. The name was changed to Seismic Design Category to represent the uses of these categories, which is to determine the specific design requirements.

The earlier editions of the *Provisions* utilized the peak velocity related acceleration,  $A_v$ , to determine a building's Seismic Performance Category. However, this coefficient does not adequately represent the damage potential of earthquakes on sites with soil conditions other than rock. Consequently, the 1997 *Provisions* adopted the use of response spectral acceleration

---

parameters  $S_{DS}$  and  $S_{DI}$ , which include site soil effects for this purpose. Instead of a single table, as was present in previous editions of the *Provisions*, two tables are now provided, relating respectively to short period and long period structures.

Seismic Design Category A represents structures in regions where anticipated ground motions are minor, even for very long return periods. For such structures, the *Provisions* require only that a complete lateral-force-resisting system be provided and that all elements of the structure be tied together. A nominal design force of 1 percent of the weight of the structure is used to proportion the lateral system.

It is not considered necessary to specify seismic-resistant design on the basis of a maximum considered earthquake ground motion for Seismic Design Category A structures because the ground motion computed for the areas where these structures are located is determined more by the rarity of the event with respect to the chosen level of probability than by the level of motion that would occur if a small but close earthquake actually did occur. However, it is desirable to provide some protection against both earthquakes and many other types of unanticipated loadings. Thus, the requirements for Seismic Design Category A provide a nominal amount of structural integrity that will improve the performance of buildings in the event of a possible but rare earthquake even though it is possible that the ground motions could be large enough to cause serious damage or even collapse. The result of design to Seismic Design Category A requirements is that fewer buildings would collapse in the vicinity of such an earthquake.

The integrity is provided by a combination of requirements. First, a complete load path for lateral forces must be identified. Then it must be designed for a lateral force equal to a 1 percent acceleration on the mass. The minimum connection forces specified for Seismic Design Category A also must be satisfied.

The 1 percent value has been used in other countries as a minimum value for structural integrity. For many structures, design for the wind loadings specified in the local buildings codes normally will control the lateral force design when compared to the minimum integrity force on the structure. However, many low-rise, heavy structures or structures with significant dead loads resulting from heavy equipment may be controlled by the nominal 1 percent acceleration. Also, minimum connection forces may exceed structural forces due to wind in some structures.

Seismic Design Category B includes Seismic Use Group I and II structures in regions of seismicity where only moderately destructive ground shaking is anticipated. In addition to the requirements for Seismic Design Category A, structures in Seismic Design Category B must be designed for forces determined using Maps 1 through 24.

Seismic Design Category C includes Seismic Use Group III structures in regions where moderately destructive ground shaking may occur as well as Seismic Use Group I and II structures in regions with somewhat more severe ground shaking potential. In Seismic Design Category C, the use of some structural systems is limited and some nonstructural components must be specifically design for seismic resistance.

Seismic Design Category D includes structures of Seismic Use Group I, II, and III located in regions expected to experience destructive ground shaking but not located very near major active faults. In Seismic Design Category D, severe limits are placed on the use of some structural

systems and irregular structures must be subjected to dynamic analysis techniques as part of the design process.

Seismic Design Category E includes Seismic Use Group I and II structures in regions located very close to major active faults and Seismic Design Category F includes Seismic Use Group III structures in these locations. Very severe limitations on systems, irregularities, and design methods are specified for Seismic Design Categories E and F. For the purpose of determining if a structure is located in a region that is very close to a major active fault, the *Provisions* use a trigger of a mapped maximum considered earthquake spectral response acceleration at 1 second periods,  $S_1$ , of 0.75g or more regardless of the structure's fundamental period. The mapped short period acceleration,  $S_s$ , was not used for this purpose because short period response accelerations do not tend to be affected by near-source conditions as strongly as do response accelerations at longer periods.

Local or regional jurisdictions enforcing building regulations need to consider the effect of the maps, typical soil conditions, and Seismic Design Categories on the practices in their jurisdictional areas. For reasons of uniformity of practice or reduction of potential errors, adopting ordinances could stipulate particular values of ground motion, particular Site Classes, or particular Seismic Design Categories for all or part of the area of their jurisdiction. For example:

1. An area with an historical practice of high seismic zone detailing might mandate a minimum Seismic Design Category of D regardless of ground motion or Site Class.
2. A jurisdiction with low variation in ground motion across the area might stipulate particular values of the ground motion rather than requiring use of the maps.
3. An area with unusual soils might require use of a particular Site Class unless a geotechnical investigation proves a better Site Class.

**4.2.2 Site Limitation for Seismic Design Category E and F Structures:** The forces that result on a structure located astride the trace of a fault rupture that propagates to the surface are extremely large and it is not possible to reliably design a structure to resist such forces. Consequently, the requirements of this section limit the construction of buildings in Seismic Design Categories E and F on sites subject to this hazard. Similarly, the effects of landsliding, liquefaction, and lateral spreading can be highly damaging to a building. However, the effects of these site phenomena can more readily be mitigated through the incorporation of appropriate design measures than can direct ground fault rupture. Consequently, construction on sites with these hazards is permitted, if appropriate mitigation measures are included in the design.

## REFERENCES

Borcherdt, R. D. 1994. "Simplified Site Classes and Empirical Amplification Factors for Site-Dependent Code Provisions." In *Proceedings of the NCEER/SEAOC/BSSC Workshop on Site Response During Earthquakes and Seismic Code Provisions*, University of Southern California, Los Angeles, November 18-20, edited by G. M. Martin.

Borcherdt, R. D. 1993. "General Methodology for Estimating Free-Field Site Specific Response Spectra." In Minutes of the Building Seismic Safety Council meeting, April 5-6, 1993, San Francisco, California.

- Borcherdt, R. D., and G. Glassmoyer. 1993. "Influence of Local Geology and Weak Ground Motions in the San Francisco Bay Region, California, and Their Implications for Site-Specific Code Provisions." In *The Loma Prieta Earthquake of October 17, 1989 - Strong Ground Motion*, USGS Professional Paper 1551-A, edited by R. D. Borcherdt.
- Dobry, R., G. M. Martin, E. Parra, and A. Bhattacharyya. 1994a. "Development of Site-Dependent Ratios of Elastic Response Spectra (RRS) and Site Categories for Building Seismic Codes." In *Proceedings of the NCEER/SEAOC/BSSC Workshop on Site Response During Earthquakes and Seismic Code Provisions*, University of Southern California, Los Angeles, November 18-20, edited by G. M. Martin.
- Dobry, R., G. M. Martin, E. Parra, and A. Bhattacharyya. 1994b. *Study of Ratios of Response Spectra Soil/Rock and of Site Categories for Seismic Codes*. Buffalo, New York: National Center for Earthquake Engineering Research.
- Hayashi, S., Tsuchida, and E. Kurata. 1971. "Average Response Spectra for Various Subsoil Conditions." Paper presented at the Third Joint Meeting of the U.S.-Japan Panel on Wind and Seismic Effects, UNJR, Tokyo, May 10-12.
- Housner, G. W. 1990. *Competing Against Time: Report to Governor George Deukmejian from the Governor's Board of Inquiry on the 1989 Loma Prieta Earthquake*.
- Idriss, I. M. 1990a. "Response of Soft Soil Sites During Earthquakes." In *Proceedings of the Symposium to Honor Professor H. B. Seed*, Berkeley.
- Idriss, I. M. 1990b. "Influence of Local Site Conditions on Earthquake Ground Motions." In *Proceedings of the 4<sup>th</sup> U.S. National Conference on Earthquake Engineering*, Palm Springs, Vol. 1, pp. 55-57.
- Jacob, K. 1990. "Seismic Hazards and the Effects of Soils on Ground Motions for the Greater New York City Metropolitan Region." In *Geotechnical Aspects of Seismic Design in the N.Y.C. Metropolitan Areas; Risk Assessment, Code Requirements and Design Techniques*, ASCE Metropolitan Section, page 24, New York, New York, November 13-14.
- Jacob, K. 1991. "Seismic Zonation and Site Response: Are Building-Code Soil Factors Adequate to Account for Variability of Soil Conditions Across the US?" In *Proceedings of the 4th International Conference on Seismic Zonation*, Vol. II, pp. 695-702. Oakland, California: Earthquake Engineering Research Institute.
- Joyner, W. B., T. E. Fumal, and G. Glassmoyer. 1994. "Empirical Spectral Response Ratios for Strong Motion Data from the 1989 Loma Prieta, California, Earthquake." In *Proceedings of the NCEER/SEAOC/BSSC Workshop on Site Response During Earthquakes and Seismic Code Provisions*, University of Southern California, Los Angeles, November 18-20, edited by G. M. Martin.
- Martin, G. M., Editor. 1994. *Proceedings of the NCEER/SEAOC/BSSC Workshop on Site Response During Earthquakes and Seismic Code Provisions*, University of Southern California, Los Angeles, November 18-20.

- Milne, W. G., and A. G. Davenport. 1969. "Distribution of Earthquake Risk in Canada." *Bulletin of the Seismological Society of America* 59(2):754-779.
- Mohraz, B. 1976. "A Study of Earthquake Response Spectra for Different Geological Conditions." *Bulletin of the Seismological Society of America* 66 (3):915-935.
- Newmark, N. M. 1973. *A Study of Vertical and Horizontal Spectra*, Report WASH-1255. Washington, D.C.: U.S. Atomic Energy Commission, Directorate of Licensing.
- Ordaz, M., and Arciniegas. 1992. Personal communication to Ricardo Dobry.
- Rinne, E., and R. Dobry. 1992. Preliminary Site Recommendations, Memorandum to Roland Sharpe, Chairman TS 2, Building Seismic Safety Council, December 11.
- Roesset, J. M. 1977. "Soil Amplification of Earthquakes." In *Numerical Methods in Geotechnical Engineering*, edited by C. S. Desai and J. T. Christian, Chapter 19, pp. 639-682. New York: McGraw-Hill.
- Seed, R. B. 1994. In *Proceedings of the NCEER/SEAOC/BSSC Workshop on Site Response During Earthquakes and Seismic Code Provisions*, University of Southern California, Los Angeles, November 18-20, edited by G. M. Martin.
- Seed, R. B., S. E. Dickenson, G. A. Rau, R. K. White, and C. M. Mok. 1992. "Observations Regarding Seismic Response Analyses for Soft and Deep Clay Sites."
- Seed, R., S. E. Dickenson, M. F. Riemer, J. D. Bray, N. Sitar, J. K. Mitchell, I. M. Idriss, R. E. Kayen, A. Kropp, L. F. Harder Jr., and M. S. Power. 1990. *Preliminary Report on the Principal Geotechnical Aspects of the October 17, 1989, Loma Prieta Earthquake*. Report UCB/EERC-90/05. Berkeley, California: EERC.
- Seed, H. B., R. Murarka, J. Lysmer, and I. M. Idriss. 1976a. "Relationships Between Maximum Acceleration, Maximum Velocity, Distance from Source and Local Site Conditions for Moderately Strong Earthquakes." *Bulletin of the Seismological Society of America* 66 (4):1323-1342.
- Seed, H. B., M. P. Romo, J. I. Sun, A. Jaime, and J. Lysmer. 1988. "The Mexico Earthquake of September 19, 1985--Relationships Between Soil Conditions and Earthquake Ground Motions." *Earthquake Spectra* 4(4):687-729.
- Seed, H. B., C. Ugas, and J. Lysmer. 1976b. "Site Dependent Spectra for Earthquake-Resistant Design." *Bulletin of the Seismological Society of America* 66 (1):221-244.
- Seed, H. B., C. Ugas, and J. Lysmer. 1974. *Site-Dependent Spectra for Earthquake-Resistant Design*, Report EERC 74-12. Berkeley, California: EERC.
- Silva, W. 1992. Personal communication to Ricardo Dobry.
- Structural Engineers Association of California. 1970. *Report of the Ad Hoc Committee on Cost of Design for Earthquakes*. Washington, D.C.: Office of Science and Technology, Task Force on Earthquake Hazard Reduction.

Su, F., K. Aki, T. Teng, Y. Zeng, S. Koyanagi, and K. Mayeda. 1992. "The Relation Between Site Amplification Factor and Surficial Geology in Central California." *Bulletin of the Seismological Society of America* 82(2):580-602.

Vucetic, M., and R. Dobry. 1991. "Effect of Soil Plasticity on Cyclic Response." *Journal of Geotechnical Engineering*, ASCE, 117(1):89-107.

Whitman, R., Editor. 1992. *Proceedings of the Site Effects Workshop, October 24-24, 1991*, Report NCEER-92-0006. Buffalo, New York: National Center for Earthquake Engineering Research.



## Chapter 5 Commentary

### STRUCTURAL DESIGN CRITERIA

**5.1 REFERENCE DOCUMENT:** ASCE 7 is referenced for the combination of earthquake loadings with other loads as well as for the computation of other loads; it is not referenced for the computation of earthquake loads.

**5.2 DESIGN BASIS:** Structural design for acceptable seismic resistance includes:

1. The selection of vertical and lateral-force-resisting systems that are appropriate to the anticipated intensity of ground shaking;
2. Layout of these systems such that they provide a continuous, regular and redundant load path capable of ensuring that the structures act as integral units in responding to ground shaking; and
3. Proportioning the various members and connections such that adequate lateral and vertical strength and stiffness is present to limit damage in a design earthquake to acceptable levels.

In the *Provisions*, the proportioning of structures' elements (sizing of individual members, connections, and supports) is typically based on the distribution of internal forces computed based on linear elastic response spectrum analyses using response spectra that are representative of, but substantially reduced from the anticipated design ground motions. As a result, under the severe levels of ground shaking anticipated for many regions of the nation, the internal forces and deformations produced in most structures will substantially exceed the point at which elements of the structures start to yield and buckle and behave in an inelastic manner. This approach can be taken because historical precedent, and the observation of the behavior of structures that have been subjected to earthquakes in the past demonstrates that if suitable structural systems are selected, and structures are detailed with appropriate levels of ductility, regularity, and continuity, it is possible to perform an elastic design of structures for reduced forces and still achieve acceptable performance. Therefore, these procedures adopt the approach of proportioning structures such that under prescribed design lateral forces that are significantly reduced, by the response modification coefficient  $R$ , from those that would actually be produced by a design earthquake they will not deform beyond a point of significant yield. The elastic deformations calculated under these reduced design forces are then amplified, by the deflection amplification factor  $C_d$  to estimate the expected deformations likely to be experienced in response to the design ground motion. (The deflection amplification is specified in Sec. 5.3.7.) Considering the intended structural performance and acceptable deformation levels, Sec. 5.2.8 prescribes the story drift limits for the expected (i.e. amplified) deformations. These procedures differ from those in earlier codes and design provisions wherein the drift limits were treated as a serviceability check.

The term "significant yield" is not the point where first yield occurs in any member but, rather, is defined as that level causing complete plastification of at least the most critical region of the structure (e.g., formation of a first plastic hinge in the structure). A structural steel frame comprised of compact members is assumed to reach this point when a "plastic hinge" develops in the most highly stressed member of the structure. A concrete frame reaches this significant yield when at

least one of the sections of its most highly stressed component reaches its strength as set forth in Chapter 9. For other structural materials that do not have their sectional yielding capacities as easily defined, modifiers to working stress values are provided. These requirements contemplate that the design includes a seismic force resisting system with redundant characteristics wherein significant structural overstrength above the level of significant yield can be obtained by plasticification at other points in the structure prior to the formation of a complete mechanism. For example, Figure C5.2-1 shows the lateral load-deflection curve for a typical structure. Significant yield is the level where plasticification occurs at the most heavily loaded element in the structure, shown as the lowest yield hinge on the load-deflection diagram. With increased loading, causing the formation of additional plastic hinges, the capacity increases (following the solid curve) until a maximum is reached. The overstrength capacity obtained by this continued inelastic action provides the reserve strength necessary for the structure to resist the extreme motions of the actual seismic forces that may be generated by the design ground motion.

It should be noted that the structural overstrength described above results from the development of sequential plastic hinging in a properly designed, redundant structure. Several other sources will further increase structural overstrength. First, material overstrength (i.e. actual material

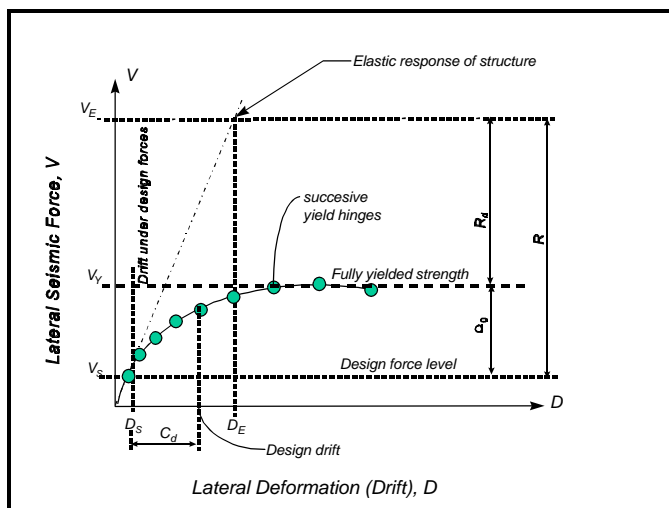

FIGURE C5.2-1 Inelastic force-deformation curve.

strengths higher than the nominal material strengths specified in the design) may increase the structural overstrength significantly. For example, a recent survey shows that the mean yield strength of A36 steel is about 30 to 40 percent higher than the minimum specified strength, nominally used in design calculations. Second, member design strengths usually incorporate a strength reduction (or resistance) factor,  $R$ , to ensure a low probability of failure under design loading. Third, designers themselves introduce additional overstrength by selecting sections or specifying reinforcing patterns that exceed those required by the computations. Similar situations occur

when minimum requirements of the *Provisions*, for example, minimum reinforcement ratios, control the design. Finally, the design of many flexible structural systems, such as moment resisting frames, are often controlled by the drift rather than strength limitations of the *Provisions*, with sections selected to control lateral deformations rather than provide the specified strength. The results is that structures typically have a much higher lateral resistance than specified as a minimum by the *Provisions* and first actual significant yielding of structures may occur at lateral load levels that are 30 to 100 percent higher than the prescribed design seismic forces. If provided with adequate ductile detailing, redundancy and regularity, full yielding of structures may occur at load levels that are two to four times the prescribed design force levels.

Figure C5.2-1 indicates the significance of design parameters contained in the *Provisions* including the response modification coefficient,  $R$ , the deflection amplification factor,  $C_d$ , and the

structural overstrength coefficient  $\phi$ . The values of the response modification coefficient,  $R$ , structural overstrength coefficient,  $\phi$ , and the deflection amplification factor,  $C_d$ , provided in Table 5.2.2, as well as the criteria for story drift including  $P$ -delta effects have been established considering the characteristics of typical properly designed structures. If excessive “optimization” of a structural design is performed, with lateral resistance provided by only a few elements, the successive yield hinge behavior depicted in Figure C5.2-1 will not be able to form and the values of the design parameters contained in the *Provisions* may not be adequate to provide the intended seismic performance.

The response modification coefficient,  $R$ , essentially represents the ratio of the forces that would develop under the specified ground motion if the structure had an entirely linearly elastic response to the prescribed design forces (see Figure C5.2-1). The structure is to be designed so that the level of significant yield exceeds the prescribed design force. The ratio  $R$ , expressed by the equation:

$$R = \frac{V_E}{V_S} \quad (\text{C5.2.1-1})$$

is always larger than 1.0; thus, all structures are designed for forces smaller than those the design ground motion would produce in a completely linear-elastic responding structure. This reduction is possible for a number of reasons. As the structure begins to yield and deform inelastically, the effective period of response of the structure tends to lengthen, which for many structures, results in a reduction in strength demand. Furthermore, the inelastic action results in a significant amount of energy dissipation, also known as hysteretic damping, in addition to the viscous damping. The combined effect, which is also known as the ductility reduction, explains why a properly designed structure with a fully yielded strength ( $V_y$ , in Figure C.5.2-1) that is significantly lower than the elastic seismic force demand ( $V_E$  in Figure C.5.2.1) can be capable of providing satisfactory performance under the design ground motion excitations. Defining a system ductility reduction factor  $R_d$  as the ratio between  $V_E$  and  $V_Y$  (Newmark and Hall, 1981):

$$R_d = \frac{V_E}{V_Y} \quad (\text{C5.2.1-2})$$

then it is clear from Figure C5.2-1 that the response modification coefficient,  $R$ , is the product of the ductility reduction factor and structural overstrength factor (Uang, 1991):

$$R = R_d \phi \quad (\text{C5.2.1-3})$$

The energy dissipation resulting from hysteretic behavior can be measured as the area enclosed by the force-deformation curve of the structure as it experiences several cycles of excitation. Some structures have far more energy dissipation capacity than do others. The extent of energy dissipation capacity available is largely dependent on the amount of stiffness and strength degradation the structure undergoes as it experiences repeated cycles of inelastic deformation.

Figure C5.2-2 indicates representative load-deformation curves for two simple substructures, such as a beam-column assembly in a frame. Hysteretic curve (a) in the figure is representative of the behavior of substructures that have been detailed for ductile behavior. The substructure can maintain nearly all of its strength and stiffness over a number of large cycles of inelastic deformation. The resulting force-deformation “loops” are quite wide and open, resulting in a large amount of energy dissipation capacity. Hysteretic curve (b) represents the behavior of a substructure that has not been detailed for ductile behavior. It rapidly loses stiffness under inelastic deformation and the resulting hysteretic loops are quite pinched. The energy dissipation capacity of such a substructure is much lower than that for the substructure (a). Structural systems with large energy dissipation capacity have larger  $R_d$  values, and hence are assigned higher  $R$  values, resulting in design for lower forces, than systems with relatively limited energy dissipation capacity.

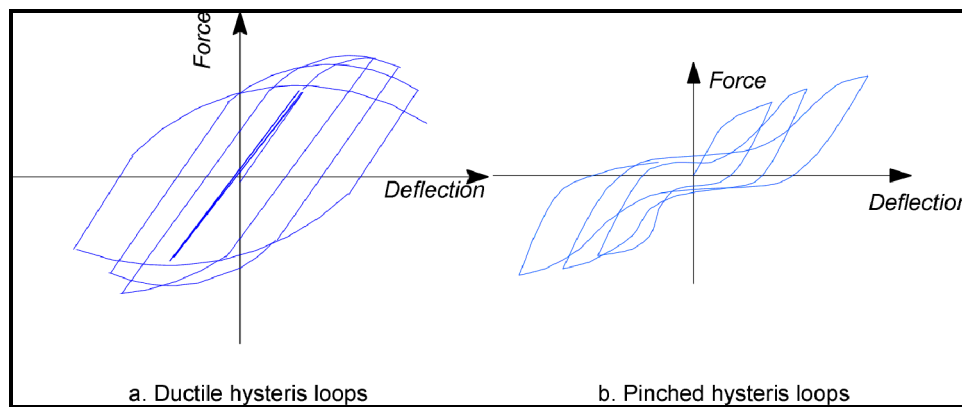

**FIGURE C5.2-2 Typical hysteretic curves.**

Some contemporary building codes, including those adopted in Canada and Europe have

attempted to directly quantify the relative contribution of overstrength and inelastic behavior to the permissible reduction in design strength. Recently, the Structural Engineers Association of California proposed such an approach for incorporation into the 1997 *Uniform Building Code*. That proposal incorporated two  $R$  factor components, termed  $R_o$  and  $R_d$  to represent the reduction due to structural overstrength and inelastic behavior, respectively. The design forces are then determined by forming a composite  $R$ , equal to the product of the two components (See Eq. C5.2.1-3). A similar approach was considered for adoption into the 1997 *NEHRP Provisions*. However, this approach was not taken for several reasons. While it was acknowledged that both structural overstrength and inelastic behavior are important contributors to the  $R$  coefficients, and can be quantified for individual structures, it was felt that there was insufficient research available at the current time to support implementation in the *Provisions*. In addition, there was concern that there can be significant variation between structures in the relative contribution of overstrength and inelastic behavior and that, therefore, this would prevent accurate quantification on a system by system basis. Finally, it was felt that this would introduce additional complexity into the *Provisions*. While it was decided not to introduce the split  $R$  value concept into the *Provisions* in the 1997 update cycle, this should be considered in the future as additional research on the inelastic behavior of structures becomes available, and as the sophistication of design offices improves to the point that quantification of structural overstrength can be done as a routine part of the design process. As a first step in this direction, however, the

factor  $\phi$  was added to Table 5.2.2, to replace the previous  $2R/5$  factor used for evaluation of brittle structural behavior modes in previous editions of the *Provisions*.

The  $R$  values, contained in the current *Provisions*, are largely based on engineering judgment of the performance of the various materials and systems in past earthquakes. The values of  $R$  must be chosen and used with careful judgment. For example, lower values must be used for structures possessing a low degree of redundancy wherein all the plastic hinges required for the formation of a mechanism may be formed essentially simultaneously and at a force level close to the specified design strength. This situation can result in considerably more detrimental  $P$ -delta effects. Since it is difficult for individual designers to judge the extent to which  $R$  factors should be adjusted, based on the inherent redundancy of their designs, a new coefficient  $\phi$ , that is calculated based on percent of the total lateral force resisted by any individual element has been introduced into the *Provisions* in Sec. 5.2.4. Additional discussion of this issue is contained in that section.

In a departure from previous editions of the *Provisions*, the 1997 edition introduces an importance factor  $I$  into the base shear equation, that varies for different types of occupancies. This importance factor has the effect of adjusting the permissible response modification factor,  $R$ , based on the desired seismic performance for the structure. It recognizes that as structures experience greater levels of inelastic behavior, they also experience more damage. Thus, introducing the importance factor,  $I$ , allows for a reduction of the  $R$  value to an effective value  $R/I$  as a partial control on the amount of damage experienced by the structure under a design earthquake. Strength alone is not sufficient to obtain enhanced seismic performance. Therefore, the improved performance characteristics desired for more critical occupancies are also obtained through application of the design and detailing requirements set forth in Sec. 5.2.6 for each Seismic Design Category and the more stringent drift limits in Table 5.2.8. These factors, in addition to strength, are extremely important to obtaining the seismic performance desired for buildings in some Seismic Use Groups.

Sec. 5.2.1 in effect calls for the seismic design to be complete and in accordance with the principles of structural mechanics. The loads must be transferred rationally from their point of origin to the final points of resistance. This should be obvious but it often is overlooked by those inexperienced in earthquake engineering.

**5.2.2 Basic Seismic-Force-Resisting Systems:** For purposes of these seismic analyses and design requirements, building framing systems are grouped in the structural system categories shown in Table 5.2.2. These categories are similar to those contained for many years in the requirements of the *Uniform Building Code*; however, a further breakdown is included for the various types of vertical components in the seismic-force-resisting system. In selecting a structural system, the designer is cautioned to consider carefully the interrelationship between continuity, toughness (including minimizing brittle behavior), and redundancy in the structural framing system as is subsequently discussed in this commentary.

Specification of  $R$  factors requires considerable judgment based on knowledge of actual earthquake performance as well as research studies; yet, they have a major effect on building costs. The factors in Table 5.2.2 continue to be reviewed in light of recent research results. In the selection of the  $R$  values for the various systems, consideration has been given to the general observed performance of each of the system types during past earthquakes, the general toughness (ability to dissipate energy without serious degradation) of the system, and the general amount of

damping present in the system when undergoing inelastic response. The designer is cautioned to be especially careful in detailing the more brittle types of systems (low  $C_d$  values).

A bearing wall system refers to that structural support system wherein major load-carrying columns are omitted and the walls and/or partitions are of sufficient strength to carry the gravity loads for some portion of the building (including live loads, floors, roofs, and the weight of the walls themselves). The walls and partitions supply, in plane, lateral stiffness and stability to resist wind and earthquake loadings as well as any other lateral loads. In some cases, vertical trusses are employed to augment lateral stiffness. In general, this system has comparably lower values of  $R$  than the other systems due to the frequent lack of redundancy for the vertical and horizontal load support. The category designated "light frame walls with shear panels" is intended to cover wood or steel stud wall systems with finishes other than masonry veneers.

A building frame system is a system in which the gravity loads are carried primarily by a frame supported on columns rather than by bearing walls. Some minor portions of the gravity load may be carried on bearing walls but the amount so carried should not represent more than a few percent of the building area. Lateral resistance is provided by nonbearing structural walls or braced frames. The light frame walls with shear panels are intended only for use with wood and steel building frames. Although there is no requirement to provide lateral resistance in this framing system, it is strongly recommended that some moment resistance be incorporated at the joints. In a structural steel frame, this could be in the form of top and bottom clip angles or tees at the beam- or girder-to-column connections. In reinforced concrete, continuity and full anchorage of longitudinal steel and stirrups over the length of beams and girders framing into columns would be a good design practice. With this type of interconnection, the frame becomes capable of providing a nominal secondary line of resistance even though the components of the seismic-force-resisting system are designed to carry all the seismic force.

A moment resisting space frame system is a system having an essentially complete space frame as in the building frame system. However, in this system, the primary lateral resistance is provided by moment resisting frames composed of columns with interacting beams or girders. Moment resisting frames may be either ordinary, intermediate, or special moment frames as indicated in Table 5.2.2 and limited by the Seismic Design Categories.

Special moment frames must meet all the design and detail requirements of Chapter 8, 9, or 11. The ductility requirements for these frame systems are appropriate for all structures anticipated to experience large inelastic demands. For this reason, they are required in zones of high seismicity with large anticipated ground shaking accelerations. In zones of lower seismicity, the inherent overstrength in typical structural designs is such that the anticipated inelastic demands are somewhat reduced, and less ductile systems may be safely employed. Intermediate moment frames of concrete must meet the requirements of Sec. 9.3.2. For buildings in which these special design and detailing requirements are not used, lower  $R$  values are specified indicating that ordinary framing systems do not possess as much toughness and that less reduction from the elastic response can be tolerated. Note that Sec. 5.2.2 (Table 5.2.2) requires moment frames in Categories D and E or F greater than 160 ft and 100 ft in height, respectively, to be special moment frames.

Requirements for composite steel-concrete systems were newly introduced in the 1994 Edition. The  $R$ ,  $\rho$ , and  $C_d$  values for the composite systems in Table 5.2.2 are similar to those for

comparable systems of structural steel and reinforced concrete. The values shown in Table 5.2.2 are only allowed when the design and detailing requirements for composite structures in Chapter 10 are followed.

Inverted pendulum structures are singled out for special consideration because of their unique characteristics. These structures have little redundancy and overstrength and concentrate inelastic behavior at their bases. As a result, they have substantially less energy dissipation capacity than other systems. A number of buildings incorporating this system experienced very severe damage, and in some cases, collapse, in the 1994 Northridge earthquake.

**5.2.2.1 Dual System:** A dual system consists of a three-dimensional space frame made up of columns and beams that provide primary support for the gravity loads. Primary lateral resistance is supplied by structural nonbearing walls or bracing; the frame is provided with a redundant lateral-force-resisting system that is a moment frame complying with the requirements of Chapters 8 and 9. The moment frame is required to be capable of resisting at least 25 percent (judgmentally selected) of the specified seismic force. Normally the moment frame would be a part of the basic space frame. The walls or bracing acting together with the moment frame must be capable of resisting all of the design seismic force. The following analyses are required for dual systems:

1. The frame and shear walls or braced frames must resist the prescribed lateral seismic force in accordance with their relative rigidities considering fully the interaction of the walls or braced frames and the moment frames as a single system. This analysis must be made in accordance with the principles of structural mechanics considering the relative rigidities of the elements and torsion in the system. Deformations imposed upon members of the *moment* frame by their interaction with the shear walls or braced frames must be considered in this analysis.
2. The moment frame must be designed to have a capacity to resist at least 25 percent of the total required lateral seismic force including torsional effects.

**5.2.2.2 Combinations of Framing Systems:** For those cases where combinations of structural systems are employed, the designer must use judgment in selecting appropriate  $R$ ,  $\rho$ , and  $C_d$  values. The intent of Sec. 5.2.2.2.1 is to prohibit support of one system by another possessing characteristics that result in a lower base shear factor. The entire system should be designed for the higher seismic shear as the provision stipulates. The exception is included to permit the use of such systems as a braced frame penthouse on a moment frame building in which the mass of the penthouse does not represent a significant portion of the total building and, thus, would not materially affect the overall response to earthquake motions.

Sec. 5.2.2.2.2 pertains to details and is included to help ensure that the more ductile details inherent with the design for the higher  $R$  value system will be employed throughout. The intent is that details common to both systems be designed to remain functional throughout the response in order to preserve the integrity of the seismic-force-resisting system.

**5.2.2.3 - 5.2.2.6 Seismic Design Categories :** General framing system requirements for the building Seismic Design Categories are given in these sections. The corresponding design and detailing requirements are given in Sec. 5.2.6 and Chapters 8 through 14. Any type of building framing system permitted by the *Provisions* may be used for Categories A, B, and C except frames limited to Category A or Categories A and B only by the requirements of Chapters 9 and

12. Limitations regarding the use of different structural systems are given for Categories D, E and F.

**5.2.2.4 Seismic Design Categories D and E:** Sec. 5.2.2.4 covers Categories D and E, which compares roughly to California design practice for normal buildings other than hospitals. According to the requirements of Chapters 8 and 9, all moment-resisting frames of steel or concrete must be special moment frames. Note that present SEAOC and *UBC* recommendations have similar requirements for concrete frames; however, ordinary moment frames of structural steel may be used for heights up to 160 ft (49 m). In keeping with the philosophy of present codes for zones of high seismic risk, these requirements continue limitations on the use of certain types of structures over 160 ft (49 m) in height but with some changes. Although it is agreed that the lack of reliable data on the behavior of high-rise buildings whose structural systems involve shear walls and/or braced frames makes it convenient at present to establish some limits, the values of 160 ft (49 m) and 240 ft (73 m) introduced in these requirements are arbitrary. Considerable disagreement exists regarding the adequacy of these values, and it is intended that these limitations be the subject of further study.

These requirements require that buildings in Category D over 160 ft (49 m) in height have one of the following seismic-force-resisting systems:

1. A moment resisting frame system with special moment frames capable of resisting the total prescribed seismic force. This requirement is the same as present SEAOC and *UBC* recommendations.
2. A dual system as defined in the Glossary, wherein the prescribed forces are resisted by the entire system and the special moment frame is designed to resist at least 25 percent of the prescribed seismic force. This requirement is also similar to SEAOC and *UBC* recommendations. The purpose of the 25 percent frame is to provide a secondary defense system with higher degrees of redundancy and ductility in order to improve the ability of the building to support the service loads (or at least the effect of gravity loads) after strong earthquake shaking. It should be noted that SEAOC and *UBC* requirements prior to 1987 required that shear walls or braced frames be able to resist the total required seismic lateral forces independently of the special moment frame. These provisions require only that the true interaction behavior of the frame-shear wall (or braced frame) system be considered (see Table 5.2.2). If the analysis of the interacting behavior is based only on the seismic lateral force vertical distribution recommended in the equivalent lateral force procedure of Sec. 5.3, the interpretation of the results of this analysis for designing the shear walls or braced frame should recognize the effects of higher modes of vibration. The internal forces that can be developed in the shear walls in the upper stories can be more severe than those obtained from such analysis.
3. The use of a shear wall (or braced frame) system of cast-in-place concrete or structural steel up to a height of 240 ft (73 m) is permitted only if braced frames or shear walls in any plane do not resist more than 50 percent of the seismic design force including torsional effects and the configuration of the lateral-force-resisting system is such that torsional effects result in less than a 20 percent contribution to the strength demand on the walls or frames. The intent is that each of these shear walls or braced frames be in a different plane and that the four or more planes required be spaced adequately throughout the plan or on the perimeter of the



building in such a way that the premature failure of one of the single walls or frames will not lead to excessive inelastic torsion.

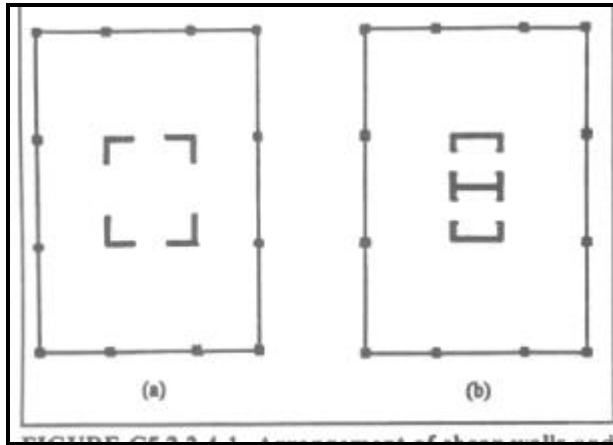

FIGURE C5.2.2.4-1 Arrangement of shear walls and braced frames--not recommended. Note that the heavy lines indicate shear walls and/or braced frames.

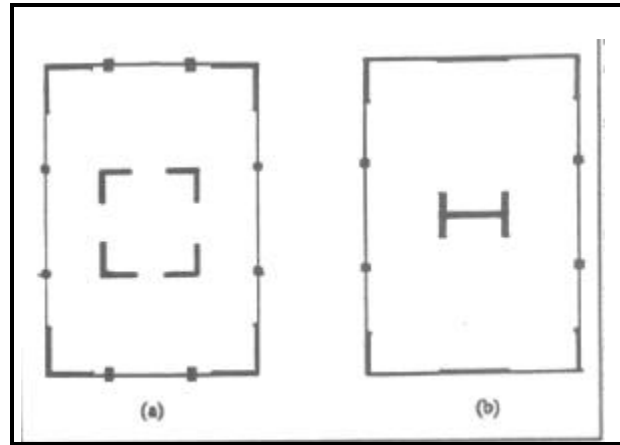

FIGURE C5.2.2.4-2 Arrangement of shear walls and braced frames-- recommended. Note that the heavy lines indicate shear walls and/or braced frames.

Although a structural system with lateral force resistance concentrated in the interior core (Figure C5.2.2.4-1) is acceptable according to the *Provisions*, it is highly recommended that use of such a system be avoided, particularly for taller buildings. The intent is to replace it by the system with lateral force resistance distributed across the entire building (Figure C5.2.2.4-2). The latter system is believed to be more suitable in view of the lack of reliable data regarding the behavior of tall buildings having structural systems based on central cores formed by coupling shear walls or slender braced frames.

**5.2.2.4.2 Interaction Effects:** This section relates to the interaction of elements of the seismic-force-resisting system with elements that are not part of this system. A classic example of such interaction is the behavior of infill masonry walls used as architectural elements in a building provided with a seismic-force-resisting system composed of moment resisting frames. Although the masonry walls are not intended to resist seismic forces, at low levels of deformation they will be substantially more rigid than the moment resisting frames and will participate in lateral force resistance. A common effect of such walls is that they can create shear-critical conditions in the columns they infill against by reducing the effective flexural height of these columns to the height of the openings in the walls. If these walls are not uniformly distributed throughout the structure, or not effectively isolated from participation in lateral force resistance they can also create torsional irregularities and soft story irregularities in structures that would otherwise have regular configuration.

Infill walls are not the only elements not included in seismic-force-resisting systems that can affect a structure's seismic behavior. For example, in parking garage structures, the ramps between levels can act as effective bracing elements and resist a large portion of the seismic induced forces. They can induce large thrusts in the diaphragms where they connect, as well as large vertical forces on the adjacent columns and beams. In addition, if not symmetrically placed in the

structure they can induce torsional irregularities. This section requires consideration of these potential effects.

**5.2.2.4.3 Deformational Compatibility:** The purpose of this section is to require that the seismic-force-resisting system provide adequate deformation control to protect elements of the structure that are not part of the seismic-force-resisting system. In regions of high seismicity, it is relatively common to apply ductile detailing requirements to elements which are intended to resist seismic forces but to neglect such practices in nonstructural elements or elements intended to only resist gravity forces. The fact that many elements of the structure are not intended to resist seismic forces and are not detailed for such resistance does not prevent them from actually participating in this resistance and becoming severely damaged as a result.

The 1994 Northridge earthquake provided several examples where this was a cause of failure. In a preliminary reconnaissance report of that earthquake (EERI, 1994) it was stated: "Of much significance is the observation that six of the seven partial collapses (in modern precast concrete parking structures) seem to have been precipitated by damage to the gravity load system. Possibly, the combination of large lateral deformation and vertical load caused crushing in poorly confined columns that were not detailed to be part of the lateral load resisting system." The report also noted that: "Punching shear failures were observed in some structures at slab-to-column connections such as at the Four Seasons building in Sherman Oaks. The primary lateral load resisting system was a perimeter ductile frame that performed quite well. However, the interior slab-column system was incapable of undergoing the same lateral deflections and experienced punching failures."

In response to a preponderance of evidence, SEAOC successfully submitted a change to the *Uniform Building Code* in 1994 to clarify and strengthen the existing requirements intended to require deformation compatibility. The statement in support of that code change included the following reasons: "Deformation compatibility requirements have largely been ignored by the design community. In the 1994 Northridge earthquake, deformation-induced damage to elements which were not part of the lateral-force-resisting system resulted in structural collapse. Damage to elements of the lateral-framing system, whose behavior was affected by adjoining rigid elements, was also observed. This has demonstrated a need for stronger and clearer requirements. The proposed changes attempt to emphasize the need for specific design and detailing of elements not part of the lateral system to accommodate expected seismic deformation...."

The new language in the 1997 *Provisions* is largely based on SEAOC's successful 1995 change to the *Uniform Building Code*. Rather than implicitly relying on designers to assume appropriate levels of stiffness, the new language in Sec. 5.2.2.4.3 explicitly requires that the "stiffening effects of adjoining rigid structural and nonstructural elements shall be considered and a rational value of member and restraint stiffness shall be used" for the design of components that are not part of the lateral-force-resisting system. This will keep designers from neglecting the potentially adverse stiffening effects that such components can have on structures. This section also adds a requirement to address shears that can be induced in structural components that are not part of the lateral-force-resisting system since sudden shear failures have been catastrophic in past earthquakes.

The exception in Sec. 5.2.4.3 is intended to encourage the use of intermediate or special detailing in beams and columns that are not part of the lateral-force-resisting system. In return for better

detailing, such beams and columns are permitted to be designed to resist moments and shears from unamplified deflections. This reflects observations and experimental evidence that well-detailed components can accommodate large drifts by responding inelastically without losing significant vertical load carrying capacity.

**5.2.2.5 Seismic Design Category F:** Sec. 5.2.2.5 covers Category F, which is restricted to essential facilities on sites located within a few kilometers of major active faults. Because of the necessity for reducing risk (particularly in terms of protecting life safety or maintaining function by minimizing damage to nonstructural building elements, contents, equipment, and utilities), the height limitations for Category F are reduced. Again, the limits--100 ft (30 m) and 160 ft (49 m)--are arbitrary and require further study. The developers of these requirements believe that, at present, it is advisable to establish these limits, but the importance of having more stringent requirements for detailing the seismic-force-resisting system as well as the nonstructural components of the building must be stressed. Such requirements are specified in Sec. 5.2.6 and Chapters 8 through 12.

**5.2.3 Structure Configuration:** The configuration of a structure can significantly affect its performance during a strong earthquake that produces the ground motion contemplated in the *Provisions*. Configuration can be divided into two aspects, plan configuration and vertical configuration. The *Provisions* were basically derived for buildings having regular configurations. Past earthquakes have repeatedly shown that buildings having irregular configurations suffer greater damage than buildings having regular configurations. This situation prevails even with good design and construction. There are several reasons for this poor behavior of irregular structures. In a regular structure, inelastic demands produced by strong ground shaking tend to be well distributed throughout the structure, resulting in a dispersion of energy dissipation and damage. However, in irregular structures, inelastic behavior can concentrate in the zone of irregularity, resulting in rapid failure of structural elements in these areas. In addition, some irregularities introduce unanticipated stresses into the structure which designers frequently overlook when detailing the structural system. Finally, the elastic analysis methods typically employed in the design of structures often can not predict the distribution of earthquake demands in an irregular structure very well, leading to inadequate design in the zones of irregularity. For these reasons, these requirements are designed to encourage that buildings be designed to have regular configurations and to prohibit gross irregularity in buildings located on sites close to major active faults, where very strong ground motion and extreme inelastic demands can be experienced.

**5.2.3.2 Plan Irregularity:** Sec. 5.2.3.2 indicates, by reference to Table 5.2.3.2, when a building must be designated as having a plan irregularity for the purposes of the *Provisions*. A building may have a symmetrical geometric shape without re-entrant corners or wings but still be classified as irregular in plan because of distribution of mass or vertical seismic resisting elements. Torsional effects in earthquakes can occur even when the static centers of mass and resistance coincide. For example, ground motion waves acting with a skew with respect to the building axis can cause torsion. Cracking or yielding in a nonsymmetrical fashion also can cause torsion. These effects also can magnify the torsion due to eccentricity between the static centers. For this reason, buildings having an eccentricity between the static center of mass and the static center of resistance in excess of 10 percent of the building dimension perpendicular to the direction of the seismic force should be classified as irregular. The vertical resisting components may be arranged so that the static centers of mass and resistance are within the limitations given above and still be

unsymmetrically arranged so that the prescribed torsional forces would be unequally distributed to the various components. In the 1997 *Provisions*, torsional irregularities have been subdivided into two categories, with a category of extreme irregularity having been created. Extreme torsional irregularities are prohibited for structures located very close to major active faults and should be avoided, when possible, in all structures.

There is a second type of distribution of vertical resisting components that, while not being classified as irregular, does not perform well in strong earthquakes. This arrangement is termed a core-type building with the vertical components of the seismic-force-resisting system concentrated near the center of the building. Better performance has been observed when the vertical components are distributed near the perimeter of the building. In recognition of the problems leading to torsional instability, a torsional amplification factor is introduced in Section 5.3.5.2.

A building having a regular configuration can be square, rectangular, or circular. A square or rectangular building with minor re-entrant corners would still be considered regular but large re-entrant corners creating a crucifix form would be classified as an irregular configuration. The response of the wings of this type of building is generally different from the response of the building as a whole, and this produces higher local forces than would be determined by application of the *Provisions* without modification. Other plan configurations such as H-shapes that have a geometrical symmetry also would be classified as irregular because of the response of the wings.

Significant differences in stiffness between portions of a diaphragm at a level are classified as irregularities since they may cause a change in the distribution of seismic forces to the vertical components and create torsional forces not accounted for in the normal distribution considered for a regular building. Examples of plan irregularities are illustrated in Figure C5.2.3.2.

Where there are discontinuities in the lateral force resistance path, the structure can no longer be considered to be "regular." The most critical of the discontinuities to be considered is the out-of-plane offset of vertical elements of the seismic force resisting elements. Such offsets impose vertical and lateral load effects on horizontal elements that are, at the least, difficult to provide for adequately.

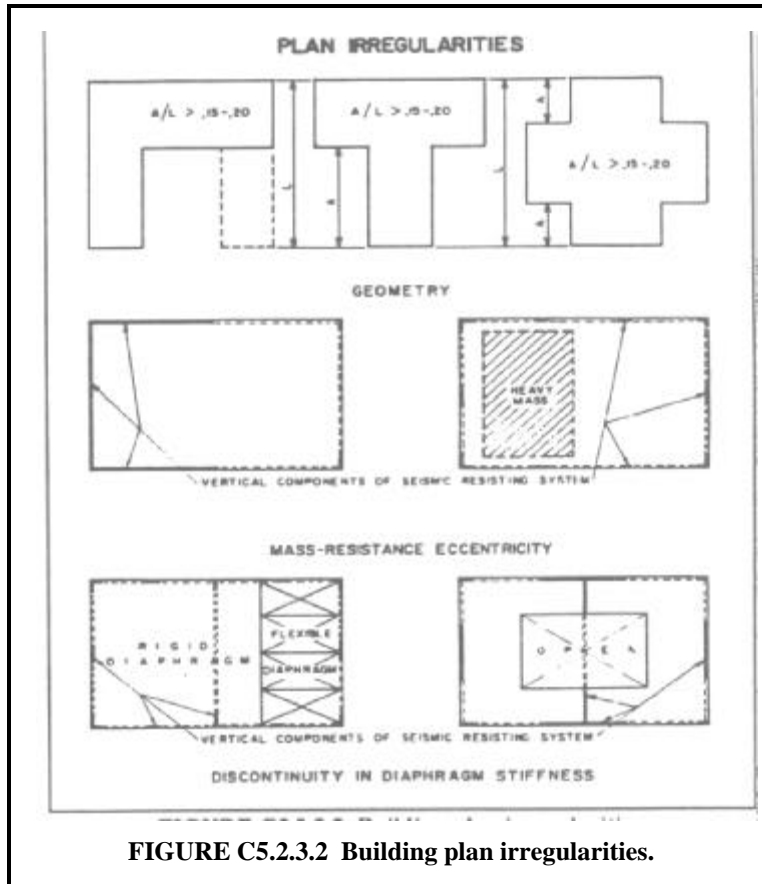

Where vertical elements of the lateral-force-resisting system are not parallel to or symmetric with major orthogonal axes, the static lateral force procedures of the *Provisions* cannot be applied as given and, thus, the structure must be considered to be "irregular."

**5.2.3.3 Vertical Irregularity:** Sec. 5.2.3.3 indicates, by reference to Table 5.2.3.3, when a structure must be considered to have a vertical irregularity. Vertical configuration irregularities affect the responses at the various levels and induce loads at these levels that are significantly different from the distribution assumed in the equivalent lateral force procedure given in Sec. 5.3.

A moment resisting frame building might be classified as having a vertical irregularity if one story were much taller than the adjoining stories and the resulting decrease in stiffness that would normally occur was not, or could not be, compensated for. Examples of vertical irregularities are illustrated in Figure C5.2.3.3.

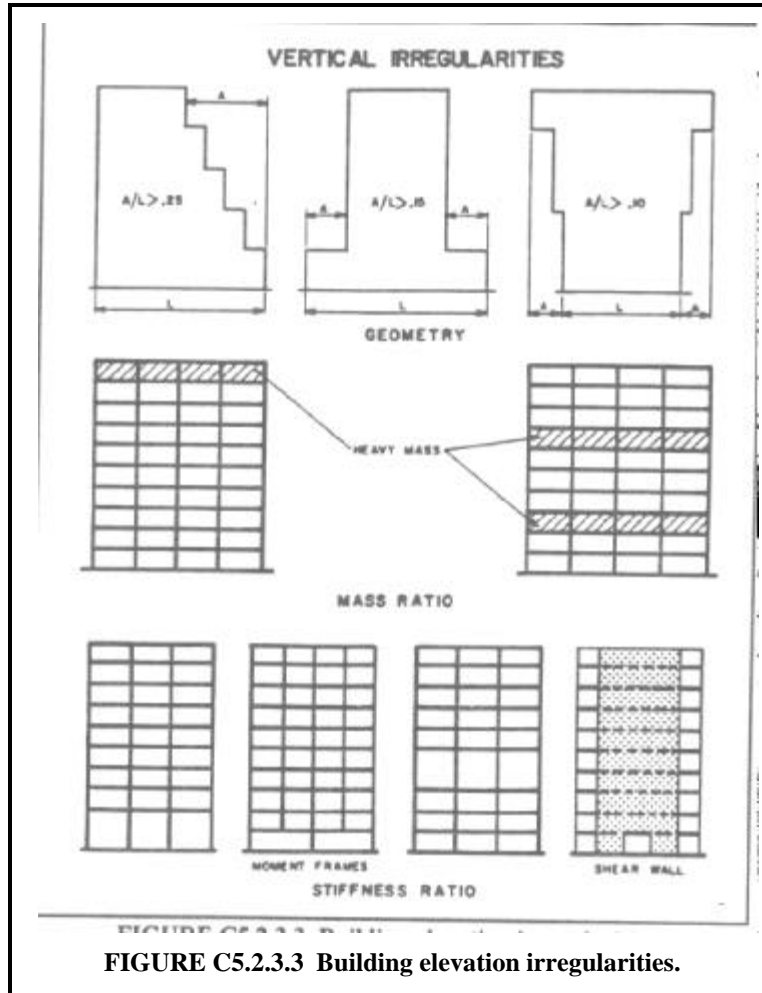

A building would be classified as irregular if the ratio of mass to stiffness in adjoining stories differs significantly. This might occur when a heavy mass, such as a swimming pool, is placed at one level. Note that the exception in the *Provisions* provides a comparative stiffness ratio between stories to exempt structures from being designated as having a vertical irregularity of the types specified.

One type of vertical irregularity is created by unsymmetrical geometry with respect to the vertical axis of the building. The building may have a geometry that is symmetrical about the vertical axis and still be classified as irregular because of significant horizontal offsets in the vertical elements of the lateral-force-resisting system at one or more levels. An offset is considered to be significant if the ratio of the larger dimension to the smaller dimension is more than 130 percent. The building also would be considered irregular if the smaller dimension were below the larger dimension, thereby creating an inverted pyramid effect.

Weak story irregularities occur whenever the strength of a story to resist lateral demands is significantly less than that of the story above. This is because buildings with this configuration tend to develop all of their inelastic behavior at the weak story. This can result in a significant

change in the deformation pattern of the building, with most earthquake induced displacement occurring within the weak story. This can result in extensive damage within the weak story and even instability and collapse. Note that an exception has been provided in Sec. 5.2.6.2.4 when there is considerable overstrength of the "weak" story.

In the 1997 *Provisions*, the soft story irregularity has been subdivided into two categories with an extreme soft story category being created. Like weak stories, soft stories can lead to instability and collapse. Buildings with extreme soft stories are now prohibited on sites located very close to major active faults.

**5.2.4 Redundancy:** The 1997 *Provisions* introduces specific requirements intended to quantify the importance of redundancy. Many parts of the *Provisions*, particularly the response modification coefficients,  $R$ , were originally developed assuming that structures possess varying levels of redundancy that heretofore were undefined. *Commentary* Sec. 5.2.1 recommends that lower  $R$  values be used for non-redundant systems, but does not provide guidance on how to select and justify appropriate reductions. As a result, many non-redundant structures have been designed in the past using values of  $R$  that were intended for use in designing structures with higher levels of redundancy. For example, current  $R$  values for special moment resisting frames were initially established in the 1970s based on the then widespread use of complete or nearly complete frame systems in which all beam-column connections were designed to participate in the lateral-force-resisting system. High  $R$  values were justified by the large number of potential hinges that could form in such redundant systems, and the beneficial effects of progressive yield hinge formation described in Sec. C5.2.1. However, in recent years, economic pressures have encouraged the now prevalent use of much less redundant special moment frames with relatively few bays of moment resisting framing supporting large floor and roof areas. Similar observations have been made of other types of construction as well. Modern concrete and masonry shear wall buildings, for example, have many fewer walls than were once commonly provided in such buildings.

In order to quantify the effects of redundancy, the 1997 *Provisions* introduce the concept of a reliability factor,  $\phi$ , that is applied to the design earthquake loads in the basic load combination equations of Sec. 5.6, for structures in Seismic Design Categories D, E, and F. The value of the reliability factor  $\phi$  varies from 1 to 1.5. In effect this reduces the  $R$  values for less redundant structures and should provide greater economic incentive for the design of structures with well distributed lateral-force-resisting systems. The formulation for the equation from which  $\phi$  is derived is similar to that developed by SEAOC for inclusion in the 1997 edition of the *Uniform Building Code*. It bases the value of  $\phi$  on the floor area of the building and the parameter "r" which relates to the amount of the building's design lateral force carried by any single element.

There are many other considerations than just floor area and element/story shear ratios that should be considered in quantifying redundancy. Conceptually, the element demand/capacity ratios, types of mechanisms which may form, the individual characteristics of building systems and materials, building height, number of stories, irregularity, torsional resistance, chord and collector length, diaphragm spans, the number of lines of resistance, and the number of elements per line are all important and will intrinsically influence the level of redundancy in systems and their reliability.

The SEAOC proposed code change to the *1997 UBC* recommends addressing redundancy in irregular buildings by evaluating the ratio of element shear to design story shear, “r” only in the lower one-third height. However, many failures of buildings have occurred at and above mid-heights. Therefore, the *Provisions* base the  $r$  factor on the worst “r” for the least redundant story, which should then be applied throughout the height of the building.

The Applied Technology Council, in its as-yet-unpublished final draft ATC 19 report suggests that future redundancy factors be based on reliability theory. For example, if the number of hinges in a moment frame required to achieve a minimally redundant system were established, a redundancy factor for less redundant systems could be based on the relationship of the number of hinges actually provided to those required for minimally redundant systems. ATC suggests that similar relationships could be developed for shear wall systems using reliability theory. However, much work yet remains to be completed before such approaches will be ready for adoption into the *Provisions*.

The *Provisions* limit special moment resisting frames to configurations that provide maximum values of 1.25 and 1.1, respectively, in Seismic Design Categories D, and E or F, to compensate for the strength based factor in what are typically drift controlled systems. Other seismic-force-resisting systems that are not typically drift controlled may be proportioned to exceed the maximum  $r$  factor of 1.5; however, it is not recommended that this be done.

**5.2.5 ANALYSIS PROCEDURES:** Many of the standard procedures for the analysis of forces and deformations in structures subjected to earthquake ground motion, including the two procedures specified in the *Provisions*, are listed below in order of increasing rigor and expected accuracy:

1. Equivalent lateral force procedure (Sec. 5.3).
2. Modal analysis procedure (response spectrum analysis) (Sec. 5.4).
3. Inelastic static procedure, involving incremental application of a pattern of lateral forces and adjustment of the structural model to account for progressive yielding under load application (push-over analysis).
4. Inelastic response history analysis involving step-by-step integration of the coupled equations of motion.

Each procedure becomes more rigorous if effects of soil-structure interaction are considered, either as presented in Sec. 5.5 or through a more complete analysis of this interaction as appropriate. Every procedure improves in rigor if combined with use of results from experimental research (not described in these *Provisions*).

The equivalent lateral force (ELF) procedure specified in Sec. 5.3 is similar in its basic concept to SEAOC recommendations in 1968, 1973, and 1974, but several improved features have been incorporated. A significant revision to this procedure, that more closely adopts the direct consideration of ground motion response spectra, has been adopted in the *1997 Provisions* in parallel with a similar concept developed by SEAOC.

The modal superposition method is a general procedure for linear analysis of the dynamic response of structures. In various forms, modal analysis has been widely used in the earthquake-resistant design of special structures such as very tall buildings, offshore drilling platforms, dams, and nuclear power plants, for a number of years; however, its use is also becoming more common for ordinary structures as



well. In previous editions of the *Provisions*, the modal analysis procedure specified in Sec. 5.4 was simplified from the general case by restricting consideration to lateral motion in a single plane. Only one degree of freedom was required per floor for this type of analysis. In recent years, with the advent of high speed, desktop computers, and the proliferation of relatively inexpensive, user-friendly structural analysis software capable of performing three dimensional modal analyses, such simplifications have become unnecessary. Consequently, the 1997 *Provisions* adopted the more general approach describing a three-dimensional modal analysis of the structure. When modal analysis is specified by the *Provisions*, a three-dimensional analysis generally is required except in the case of highly regular structures or structures with flexible diaphragms.

The ELF procedure of Sec. 5.3 and the modal analysis procedure of Sec. 5.4 are both based on the approximation that the effects of yielding can be adequately accounted for by linear analysis of the seismic-force-resisting system for the design spectrum, which is the elastic acceleration response spectrum reduced by the response modification factor,  $R$ . The effects of the horizontal component of ground motion perpendicular to the direction under consideration in the analysis, the vertical component of ground motion, and torsional motions of the structure are all considered in the same simplified approaches in the two procedures. The main difference between the two procedures lies in the distribution of the seismic lateral forces over the building. In the modal analysis procedure, the distribution is based on properties of the natural vibration modes, which are determined from the mass and stiffness distribution. In the ELF procedure, the distribution is based on simplified formulas that are appropriate for regular structures as specified in Sec. 5.3.4. Otherwise, the two procedures are subject to the same limitations.

The simplifications inherent in the ELF procedure result in approximations that are likely to be inadequate if the lateral motions in two orthogonal directions and the torsional motion are strongly coupled. Such would be the case if the building were irregular in its plan configuration (see Sec. 5.2.3.2) or if it had a regular plan but its lower natural frequencies were nearly equal and the centers of mass and resistance were nearly coincident. The modal analysis method introduced in the 1997 *Provisions* includes a general model that is more appropriate for the analysis of such structures. It requires at least three degrees of freedom per floor—two translational and one torsional motion.

The methods of modal analysis can be generalized further to model the effect of diaphragm flexibility, soil-structure interaction, etc. In the most general form, the idealization would take the form of a large number of mass points, each with six degrees of freedom (three translation and three rotational) connected by generalized stiffness elements.

The ELF procedure (Sec. 5.3) and the modal analysis procedure are all likely to err systematically on the unsafe side if story strengths are distributed irregularly over height. This feature is likely to lead to concentration of ductility demand in a few stories of the building. The inelastic static (or so-called pushover) procedure is a method to more accurately account for irregular strength distribution. However, it also has limitations and is not particularly applicable to tall structures or structures with relatively long fundamental periods of vibration.

The actual strength properties of the various components of a structure can be explicitly considered only by a nonlinear analysis of dynamic response by direct integration of the coupled equations of motion. This method has been used extensively in earthquake research studies of inelastic structural response. If the two lateral motions and the torsional motion are expected to be essentially uncoupled, it would be sufficient to include only one degree of freedom per floor, the motion in the direction along

which the structure is being analyzed; otherwise at least three degrees of freedom per floor, two translational motions and one torsional, should be included. It should be recognized that the results of a nonlinear response history analysis of such mathematical structural models are only as good as are the models chosen to represent the structure vibrating at amplitudes of motion large enough to cause significant yielding during strong ground motions. Furthermore, reliable results can be achieved only by calculating the response to several ground motions--recorded accelerograms and/or simulated motions--and examining the statistics of response.

It is possible with presently available computer programs to perform two- and three-dimensional inelastic analyses of reasonably simple structures. The intent of such analyses could be to estimate the sequence in which components become inelastic and to indicate those components requiring strength adjustments so as to remain within the required ductility limits. It should be emphasized that with the present state of the art in analysis, there is no one method that can be applied to all types of structures. Further, the reliability of the analytical results are sensitive to:

1. The number and appropriateness of the input motion records,
2. The practical limitations of mathematical modeling including interacting effects of inelastic elements,
3. The nonlinear solution algorithms, and
4. The assumed member hysteretic behavior.

Because of these sensitivities and limitations, the maximum base shear produced in an inelastic analysis should not be less than that required by Sec. 5.4.

The least rigorous analytical procedure that may be used in determining the design seismic forces and deformations in structures depends on the Seismic Design Category and the structural characteristics (in particular, regularity). Regularity is discussed in Sec. 5.2.3.

Neither regular nor irregular buildings in Seismic Design Category A are required to be analyzed as a whole for seismic forces, but certain minimum requirements are given in Sec. 5.2.5.1. In addition, there is a requirement that Seismic Design Category A structure should be evaluated for a total lateral force equal to a nominal percentage of their effective weight. The purpose of this provision is to assure that a complete lateral-force-resisting system is provided for all structures.

For the higher Seismic Design Categories, the ELF procedure is the minimum level of analysis except that a more rigorous procedure is required for some Category D, E and F structures as identified in Table 5.2.5.3. The modal analysis procedure adequately addresses vertical irregularities of stiffness, mass, or geometry, as limited by the *Provisions*. Other irregularities must be carefully considered.

The basis for the ELF procedure and its limitations were discussed above. It is adequate for most regular structures; however, the designer may wish to employ a more rigorous procedure (see list of procedures at beginning of this section for those regular structures where it may be inadequate). The ELF procedure is likely to be inadequate in the following cases:

1. Structures with irregular mass and stiffness properties in which case the simple equations for vertical distribution of lateral forces (Eq. 5.3.4-1 and 5.3.4-2) may lead to erroneous results;
2. Structures (regular or irregular) in which the lateral motions in two orthogonal directions and the torsional motion are strongly coupled; and

3. Structures with irregular distribution of story strengths leading to possible concentration of ductility demand in a few stories of the building.

In such cases, a more rigorous procedure that considers the dynamic behavior of the structure should be employed.

Structures with certain types of vertical irregularities may be analyzed as regular *structures* in accordance with the requirements of Sec. 5.3. These structures are generally referred to as setback structures. The following procedure may be used:

1. The base and tower portions of a building having a setback vertical configuration may be analyzed as indicated in (2) below if:
  - a. The base portion and the tower portion, considered as separate *structures*, can be classified as regular and
  - b. The stiffness of the top story of the base is at least five times that of the first story of the tower.

When these conditions are not met, the building must be analyzed in accordance with Sec. 5.4.

2. The base and tower portions may be analyzed as separate *structures* in accordance with the following:
  - a. The tower may be analyzed in accordance with the procedures in Sec. 5.3 with the base taken at the top of the base portion.
  - b. The base portion then must be analyzed in accordance with the procedures in Sec. 5.3 using the height of the base portion of  $h_n$  and with the gravity load and seismic base shear forces of the tower portion acting at the top level of the base portion.

The design requirements in Sec. 5.4 include a simplified version of modal analysis that accounts for irregularity in mass and stiffness distribution over the height of the building. It would be adequate, in general, to use the ELF procedure for *structures* whose floor masses and cross-sectional areas and moments of inertia of structural members do not differ by more than 30 percent in adjacent floors and in adjacent stories.

For other structures, the following procedure should be used to determine whether the modal analysis procedures of Sec. 5.4 should be used:

1. Compute the story shears using the ELF procedure specified in Sec. 5.3.
2. On this basis, approximately dimension the structural members, and then compute the lateral displacements of the floor.
3. Replace  $h$  in Eq. 5.3.4-2 with these displacements, and recompute the lateral forces to obtain the revised story shears.
4. If at any story the recomputed story shear differs from the corresponding value as obtained from the procedures of Sec. 5.3 by more than 30 percent, the building should be analyzed using the procedure of Sec. 5.4. If the difference is less than this value, the building may be designed using the story shear obtained in the application of the present criterion and the procedures of Sec. 5.4 are not required.

Application of this procedure to these structures requires far less computational effort than the use of the modal analysis procedure of Sec. 5.4. In the majority of the *structures*, use of this procedure will determine that modal analysis need not be used and will also furnish a set of story shears that practically always lie much closer to the results of modal analysis than the results of the ELF procedure.

This procedure is equivalent to a single cycle of Newmark's method for calculation of the fundamental mode of vibration. It will detect both unusual shapes of the fundamental mode and excessively high influence of higher modes. Numerical studies have demonstrated that this procedure for determining whether modal analysis must be used will, in general, detect cases that truly should be analyzed dynamically; however, it generally will not indicate the need for dynamic analysis when such an analysis would not greatly improve accuracy.

Section 5.2.5.3 of the *Provisions* requires "special consideration of dynamic characteristics" when:

1. The building is assigned to Seismic Design Category D, E or F and
2. The building has one or more of the plan structural irregularities listed in Table 5.2.3.2 and/or
3. The building has a vertical structural irregularity of Type 4 and/or 5 listed in Table 5.2.3.3.

When special dynamic analysis is required and irregularities of the plan type exist, three-dimensional modal analysis must be employed

### **5.2.6 DESIGN, DETAILING REQUIREMENTS, AND STRUCTURAL COMPONENT**

**LOAD EFFECTS:** The design and detailing requirements for components of the seismic-force-resisting system are stated in this section. The combination of load effects is specified in Sec. 5.2.7. The requirements of this section are spelled out in considerable detail. The major reasons for this are presented below.

The provision of detailed design ground motions and requirements for analysis of the structure do not by themselves make a building earthquake resistant. Additional design requirements are necessary to provide a consistent degree of earthquake resistance in buildings. The more severe the expected seismic ground motions, the more stringent these additional design requirements should be. Not all of the necessary design requirements are expressed in codes, and although experienced seismic design engineers account for them, engineers lacking experience in the design and construction of earthquake-resistant structures often overlook them. Considerable uncertainties exist regarding:

1. The actual dynamic characteristics of future earthquake motions expected at a building site;
2. The soil-structure-foundation interaction;
3. The actual response of buildings when subjected to seismic motions at their foundations; and
4. The mechanical characteristics of the different structural materials, particularly when they undergo significant cyclic straining in the inelastic range that can lead to severe reversals of strains.

It should be noted that the overall inelastic response of a structure is very sensitive to the inelastic behavior of its critical regions, and this behavior is influenced, in turn, by the detailing of these regions.

Although it is possible to counteract the consequences of these uncertainties by increasing the level of design forces, it is considered more feasible to provide a building system with the largest energy dissipation consistent with the maximum tolerable deformations of nonstructural components and

equipment. This energy dissipation capacity, which is usually denoted simplistically as "ductility," is extremely sensitive to the detailing. Therefore, in order to achieve such a large energy dissipation capacity, it is essential that stringent design requirements be used for detailing the structural as well as the nonstructural components and their connections or separations. Furthermore, it is necessary to have good quality control of materials and competent inspection. The importance of these factors has been clearly demonstrated by the building damage observed after both moderate and severe earthquakes.

It should be kept in mind that a building's response to seismic ground motion most often does not reflect the designer's or analyst's original conception or modeling of the structure on paper. What is reflected is the manner in which the building was constructed in the field. These requirements emphasize the importance of detailing and recognize that the detailing requirements should be related to the expected earthquake intensities and the importance of the building's function and/or the density and type of occupancy. The greater the expected intensity of earthquake ground-shaking and the more important the building function or the greater the number of occupants in the building, the more stringent the design and detailing requirements should be. In defining these requirements, the *Provisions* uses the concept of Seismic Design Categories (Tables 4.2.1a and 4.2.1b ), which relate to the design ground motion severities, given by the spectral response acceleration coefficients  $S_{DS}$  and  $S_{DI}$  (Sec. 4.1.1 ) and the Seismic Use Group (Sec. 1.3).

**5.2.6.1 Seismic Design Category A:** Because of the very low seismicity associated with sites with  $S_{DS}$  less than 0.25g and  $S_{DI}$  less than 0.10g , it is considered appropriate for Category A buildings to require only a complete lateral-force-resisting system. good quality of construction materials and adequate ties and anchorage as specified in this section. Category A buildings will be constructed in a large portion of the United States that is generally subject to strong winds but low earthquake risk. Those promulgating construction regulations for these areas may wish to consider many of the low-level seismic requirements as being suitable to reduce the windstorm risk. Since the *Provisions* considers only earthquakes, no other requirements are prescribed for Category A buildings. Only a complete lateral-force-resisting system, ties, and wall anchorage are required by these *Provisions*.

**5.2.6.1.1 Component Load Effects:** This section specifies that the direction of the applied seismic force be that which produces the most critical load effect on the building. In past codes, it was necessary only to independently consider loads on the main axes of the building. For beams and girders, this gives maximum design stresses. However, if earthquake forces affect the building in a direction other than the main axes, corner columns can be subjected to higher stresses, which may partially explain the vulnerability of such columns in past earthquakes.

**5.2.6.1.2 Connections:** The analysis of a structure and the provision of a design ground motion alone do not make a structure earthquake resistant; additional design requirements are necessary to provide adequate earthquake resistance in buildings. Experienced seismic designers normally fill these requirements, but because some were not formally specified, they often are overlooked by inexperienced engineers.

Probably the most important single attribute of an earthquake-resistant building is that it is tied together to act as a unit. This attribute not only is important in earthquake-resistant design, but also is indispensable in resisting high winds, floods, explosion, progressive failure, and even such ordinary hazards as foundation settlement. Sec. 5.2.6.1.2 requires that all parts of the building (or unit if there are separation joints) be so tied together that any part of the structure is tied to the rest to resist a force

of  $S_{DS}/7.5$  (with a minimum of 5 percent  $g$ ) times the weight of the smaller. In addition, beams must be tied to their supports or columns and columns to footings for a minimum of 5 percent of the dead and live load reaction.

Certain connections of buildings with plan irregularities must be designed for higher forces than calculated due to the simplifying assumptions used in the analysis by Sec. 5.2, 5.3, and 5.4 (see Sec. 5.2.6.4.3 ).

**5.2.6.1.3 Anchorage of Concrete or Masonry Walls:** One of the major hazards from buildings during an earthquake is the pulling away of heavy masonry or concrete walls from floors or roofs. Although requirements for the anchorage to prevent this separation are common in highly seismic areas, they have been minimal or nonexistent in most other parts of the country. This section requires that anchorage be provided in any locality to the extent of  $400S_{DS}$  pounds per linear foot (plf) or 5,840 times  $S_{DS}$  Newtons per meter (N/m). This requirement alone may not provide complete earthquake-resistant design, but observations of earthquake damage indicate that it can greatly increase the earthquake resistance of buildings and reduce hazards in those localities where earthquakes may occur but are rarely damaging.

**5.2.6.2 Seismic Design Category B:** Category B and Category C buildings will be constructed in the largest portion of the United States. Earthquake-resistant requirements are increased appreciably over Category A requirements, but they still are quite simple compared to present requirements in areas of high seismicity.

The Category B requirements specifically recognize the need to design diaphragms, provide collector bars, and provide reinforcing around openings. Their requirements may seem elementary and obvious but, because they are not specifically covered in many codes, some engineers totally neglect them.

**5.2.6.2.4 Nonredundant Systems:** Design consideration should be given to potentially adverse effects where there is a lack of redundancy. Because of the many unknowns and uncertainties in the magnitude and characteristics of earthquake loading, in the materials and systems of construction for resisting earthquake loadings and in the methods of analysis, good earthquake engineering practice has been to provide as much redundancy as possible in the seismic-force-resisting system of buildings.

Redundancy plays an important role in determining the ability of the building to resist earthquake forces. In a structural system without redundant components, every component must remain operative to preserve the integrity of the building structure. On the other hand, in a highly redundant system, one or more redundant components may fail and still leave a structural system that retains its integrity and can continue to resist lateral forces, albeit with diminished effectiveness.

Redundancy often is accomplished by making all joints of the vertical load-carrying frame moment resisting and incorporating them into the seismic-force-resisting system. These multiple points of resistance can prevent a catastrophic collapse due to distress or failure of a member or joint. (The overstrength characteristics of this type of frame were discussed in the commentary on Sec. 5.2.1.)

The designer should be particularly aware of the proper selection of  $R$  when using only one or two one-bay rigid frames in one direction for resisting seismic loads. A single one-bay frame or a pair of such frames provides little redundancy so the designer may wish to consider a modified (smaller)  $R$  to account for a lack of redundancy. As more one-bay frames are added to the system, however, overall system redundancy increases. The increase in redundancy is a function of frame placement and total number of frames.

Redundant characteristics also can be obtained by providing several different types of seismic-force-resisting systems in a building. The backup system can prevent catastrophic effects if distress occurs in the primary system.

In summary, it is good practice to incorporate redundancy into the seismic-force-resisting system and not to rely on any system wherein distress in any member may cause progressive or catastrophic collapse.

**5.2.6.2.5 Collector Elements:** Many buildings have shear walls or other bracing elements that are not uniformly spaced around the diaphragms. Such conditions require that collector or drag members be provided. A simple illustration is shown in Figure C5.2.6.2.5.

Consider a building as shown in the plan with four short shear walls at the corners arranged as shown. For north-south earthquake forces, the diaphragm shears on Line AB are uniformly distributed between A and B if the chord reinforcing is assumed to act on Lines BC and AD. However, wall A is quite short so reinforcing steel is required to collect these shears and transfer them to the wall. If Wall A is a quarter of the length of AB, the steel must carry, as a minimum, three-fourths of the total shear on Line AB. The same principle is true for the other walls. In Figure C5.2.6.2.5 reinforcing is required to collect the shears or drag the forces from the diaphragm into the shear wall. Similar collector elements are needed in most shear walls and some frames.

**5.2.6.2.6 Diaphragms:** Diaphragms are deep beams or trusses that distribute the lateral loads from their origin to the components where they are resisted. As such, they are subject to shears, bending moments, direct stresses (truss member, collector elements), and deformations. The deformations must be minimized in some cases because they could overstress the walls to which they are connected. The amount of deflection permitted in the diaphragm must be related to the ability of the walls (normal to the direction being analyzed) to deflect without failure.

A detail commonly overlooked by many engineers is the requirement to tie the diaphragm together so that it acts as a unit. Wall anchorages tend to tear off the edges of the diaphragm; thus, the ties must be extended into the diaphragm so as to develop adequate anchorage. During the San Fernando earthquake, seismic forces from the walls caused separations in roof diaphragms 20 or more ft (6 m) from the edge in several industrial buildings.

When openings occur in shear walls, diaphragms, etc., it is not adequate to only provide temperature trim bars. The chord stresses must be provided for and the chords anchored to develop the chord stresses by embedment. The embedment must be sufficient to take the reactions without overstressing the material in any respect. Since the design basis depends on an elastic analysis, the internal force system should be compatible with both static and the elastic deformations.

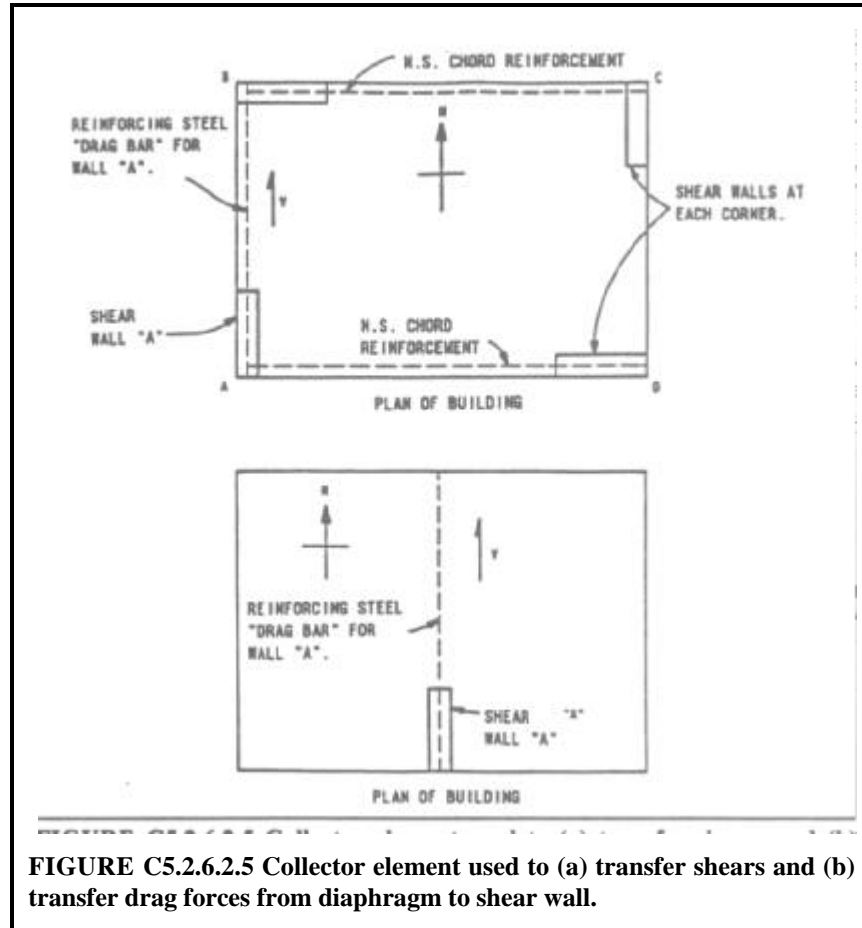

**FIGURE C5.2.6.2.5** Collector element used to (a) transfer shears and (b) transfer drag forces from diaphragm to shear wall.

**5.2.6.2.7 Bearing Walls:** A minimum anchorage of bearing walls to diaphragms or other resisting elements is specified. To ensure that the walls and supporting framing system interact properly, it is required that the interconnection of dependent wall elements and connections to the framing system have sufficient ductility or rotational capacity, or strength, to stay as a unit. Large shrinkage or settlement cracks can significantly affect the desired interaction.

**5.2.6.2.8 Inverted Pendulum-Type Structures:** Inverted pendulum-type structures have a large portion of their mass concentrated near the top and, thus, have essentially one degree of freedom in horizontal translation. Often the structures are T-shaped with a single column supporting a beam or slab at the top. For such a structure, the lateral motion is accompanied by rotation of the horizontal element of the  $T$  due to rotation at the top of the column, resulting in vertical accelerations acting in opposite directions on the overhangs of the structure. Dynamic response amplifies this rotation; hence, a bending moment would be induced at the top of the column even though the procedures of Sec. 5.3.2 and 5.3.5 would not so indicate. A simple provision to compensate for this is specified in this section. The bending moments due to the lateral force are first calculated for the base of the column according to the requirements of Sec. 5.3.2 and 5.3.5. One-half of the calculated bending moment at the base is applied at the top and the moments along the column are varied from 1.5  $M$  at the base to 0.5  $M$  at the



top. The addition of one-half the moment calculated at the base in accordance with Sec. 5.3.2 and 5.3.5 is based on analyses of inverted pendulums covering a wide range of practical conditions.

**5.2.6.2.9 Anchorage of Nonstructural Systems:** Anchorage of nonstructural systems and components of buildings is required when prescribed in Chapter 6.

**5.2.6.3 Seismic Design Category C:** The material requirements in Chapters 8 through 12 for Category C are somewhat more restrictive than those for Categories A and B. Also, a nominal inter-connection between pile caps and caissons is required.

**5.2.6.4 Seismic Design Category D:** Category D requirements compare roughly to present design practice in California seismic areas for buildings other than schools and hospitals. All moment resisting frames of concrete or steel must meet ductility requirements. Interaction effects between structural and nonstructural elements must be investigated. Foundation interaction requirements are increased.

Sec. 5.2.5.4.1 requires for Category D buildings that the effects from seismic loads applied in one direction be combined with those from the other direction. This may affect more than just the columns. The second order effect that is referenced is explained more fully in Sec. 5.3.7.

**5.2.6.4.1 Orthogonal Effects:** Earthquake forces act in both principal directions of the building simultaneously, but the earthquake effects in the two principal directions are unlikely to reach their maximum simultaneously. This section provides a reasonable and adequate method for combining them. It requires that structural elements be designed for 100 percent of the effects of seismic forces in one principal direction combined with 30 percent of the effects of seismic forces in the orthogonal direction.

The following combinations of effects of gravity loads, effects of seismic forces in the x-direction, and effects of seismic forces in the y-direction (orthogonal to x-direction) thus pertain:

$$\begin{aligned} &\text{gravity} \pm 100\% \text{ of x-direction} \pm 30\% \text{ of y-direction} \\ &\text{gravity} \pm 30\% \text{ of x-direction} \pm 100\% \text{ of y-direction} \end{aligned}$$

The combination and signs (plus or minus) requiring the greater member strength are used for each member. Orthogonal effects are slight on beams, girders, slabs, and other horizontal elements that are essentially one-directional in their behavior, but they may be significant in columns or other vertical members that participate in resisting earthquake forces in both principal directions of the building. For two-way slabs, orthogonal effects at slab-to-column connections can be neglected provided the moment transferred in the minor direction does not exceed 30 percent of that transferred in the orthogonal direction and there is adequate reinforcement within lines one and one-half times the slab thickness either side of the column to transfer all the minor direction moment.

**5.2.7 COMBINATION OF LOAD EFFECTS:** The load combination statements in the *Provisions* combine the effects of structural response to horizontal and vertical ground accelerations. They do not show how to combine the effect of earthquake loading with the effects of other loads. For those combinations, the user is referred to ASCE 7 (Ref. 5-1). The pertinent combinations are:

$$\begin{aligned} 1.2D + 1.0E + 0.5L + 0.2S & \qquad \qquad \qquad \text{(Additive)} \\ 0.9D + 1.0E & \qquad \qquad \qquad \text{(Counteracting)} \end{aligned}$$

where  $D$ ,  $E$ ,  $L$ , and  $S$  are, respectively, the dead, earthquake, live, and snow loads.

The design basis expressed in Sec. 5.2.1 reflects the fact that the specified earthquake loads are at the design level without amplification by load factors; thus, for sufficiently redundant structures, a load factor of 1.0 is assigned to the earthquake load effects in Eq. 5.2.7-1 and 5.2.7-2.

In Eq. 5.2.7-1 and 5.2.7-2, a factor of  $0.2S_{DS}$  was placed on the dead load to account for the effects of vertical acceleration. The  $0.2S_{DS}$  factor on dead load is not intended to represent the total vertical response. The concurrent maximum response of vertical accelerations and horizontal accelerations, direct and orthogonal, is unlikely and, therefore, the direct addition of responses was not considered appropriate.

The factor was introduced into Eq. 5.2.7-1 and 5.2.7-2 in the 1997 *Provisions*. This factor, determined in accordance with Sec. 5.2.4, relates to the redundancy inherent in the lateral-force-resisting system and is, in essence, a reliability factor, penalizing designs which are likely to be unreliable due to concentration of the structure's resistance to lateral forces in a relatively few elements.

There is very little research that speaks directly to the merits of redundancy in buildings for seismic resistance. The SAC joint venture recently studied the relationships between damage to welded steel moment frame connections and redundancy (Bonowitz, et al, 1995). While this study found no specific correlation between damage and the number of bays of moment resisting framing per moment frame, it did find increased rates of damage in connections that resisted larger floor areas. This study included modern low-, mid- and high-rise steel buildings.

Another study (Wood, 1991) that addresses the potential effects of redundancy evaluated the performance of 165 Chilean concrete buildings ranging from 6 to 23 stories in height. These concrete shear wall buildings with non-ductile details and no boundary elements experienced moderately strong shaking (MMI VII to VIII) with a strong shaking duration of over 60 seconds, yet performed well. One plausible explanation for this generally good performance was the substantial amount of wall area (2 to 4 percent of the floor area) commonly used in Chile. However, Wood's study found no correlation between damage rates and higher redundancy in buildings with wall areas greater than 2 percent.

The special load combination of Sect. 5.2.7.1 is intended to address those situations where failure of an isolated, individual, brittle element can result in the loss of a complete lateral-force-resisting system or in instability and collapse. This section has evolved over several editions. In the 1991 Edition, a  $2R/5$  factor was introduced to better represent the behavior of elements sensitive to overstrength in the remainder of the seismic resisting system or in specific other structural components. The particular number was selected to correlate with the  $3R_w/8$  factor that had been introduced in Structural Engineers Association of California (SEAOC) recommendations and the *Uniform Building Code*. This is a somewhat arbitrary factor that attempts to quantify the maximum force that can be delivered to sensitive elements based on historic observation that the real force that could develop in a structure may be 3 to 4 times the design levels. In the 1997 *Provisions*, an attempt has been made to determine this force more rationally through the assignment of the  $\phi$  factor in Table 5.2.2, dependent on the individual system.

The special load combinations of Eq. 5.2.6-3 and 5.2.6-4 were first introduced in the 1991 Edition of the *Provisions*, for the design of elements that could fail in an undesirable manner when subjected to demands that are significantly larger than those used to proportion them. It recognizes the fact that the

actual response (forces and deformations) developed by a structure subjected to the design earthquake ground motion will be substantially larger than that predicted by the design forces. Through the use of the  $\omega_o$  coefficient, this special equation provides an estimate of the maximum forces actually likely to be experienced by an element.

When originally introduced in the 1991 *Provisions*, the overstrength factor  $\omega_o$  was represented by the factor  $2R/5$ . That particular value was selected to correlate with the  $3R_w/8$  factor that had been previously introduced in Structural Engineers Association of California (SEAOC) recommendations and the *Uniform Building Code* in 1988. Typically, both of these factors resulted in a three to four fold amplification in the design force levels, based on the historic judgment that the real forces experienced by a structure in a major earthquake are probably on the order of 3 to 4 times the design force levels.

In recent years, a number of researchers have investigated the factors that permit structures designed for reduced forces to survive design earthquakes. Although these studies have principally been focused on the development of more reliable response modification coefficients,  $R$ , they have identified the importance of structural overstrength, and identified a number of sources of such overstrength. This has made it possible to replace the single  $2R/5$  factor formerly contained in the *Provisions* with a more system-specific estimate, represented by the  $\omega_o$  coefficient.

It is recognized, that no single value, whether obtained by formula related to the  $R$  factor or otherwise obtained will provide a completely accurate estimate for the overstrength of all structures with a given seismic-force-resisting system. However, most structures designed with a given lateral-force-resisting system, will fall within a range of overstrength values. Since the purpose of the  $W_o$  factor in Eq. 5.2.7-3 and 5.2.7-4 is to estimate the maximum force that can be delivered to a component that is sensitive to overstress, the values of this factor tabulated in Table 5.2.2 are intended to be representative of the larger values in this range for each system.

Figure C5.2.7 and the following discussion explore some of the factors that contribute to structural overstrength. The figure shows a plot of lateral structural strength vs. displacement for an elastic-perfectly-plastic structure. In addition, it shows a similar plot for a more representative real structure, that possesses significantly more strength than the design strength. This real strength is represented by the lateral force  $F_n$ . Essentially, the  $W_o$  coefficient is intended to be a somewhat conservative estimate of the ratio of  $F_n$  to the design strength  $F_E/R$ . As shown in the figure, there are three basic components to the overstrength. These are the design overstrength ( $\omega_D$ ), the material overstrength ( $\omega_M$ ) and the system overstrength ( $\omega_S$ ). Each of these is discussed separately. The design overstrength ( $\omega_D$ ) is the most difficult of the three to estimate. It is the difference between the lateral base shear force at which the first significant yield of the structure will occur (point 1 in the figure) and the minimum specified force given by  $F_E/R$ . To some extent, this is system dependent. Systems that are strength controlled, such as most braced frames and shear wall structures, will typically have a relatively low value of design overstrength, as most designers will seek to optimize their designs and provide a strength that is close to the minimum specified by the *Provisions*. For such structures, this portion of the overstrength coefficient could be as low as 1.0.

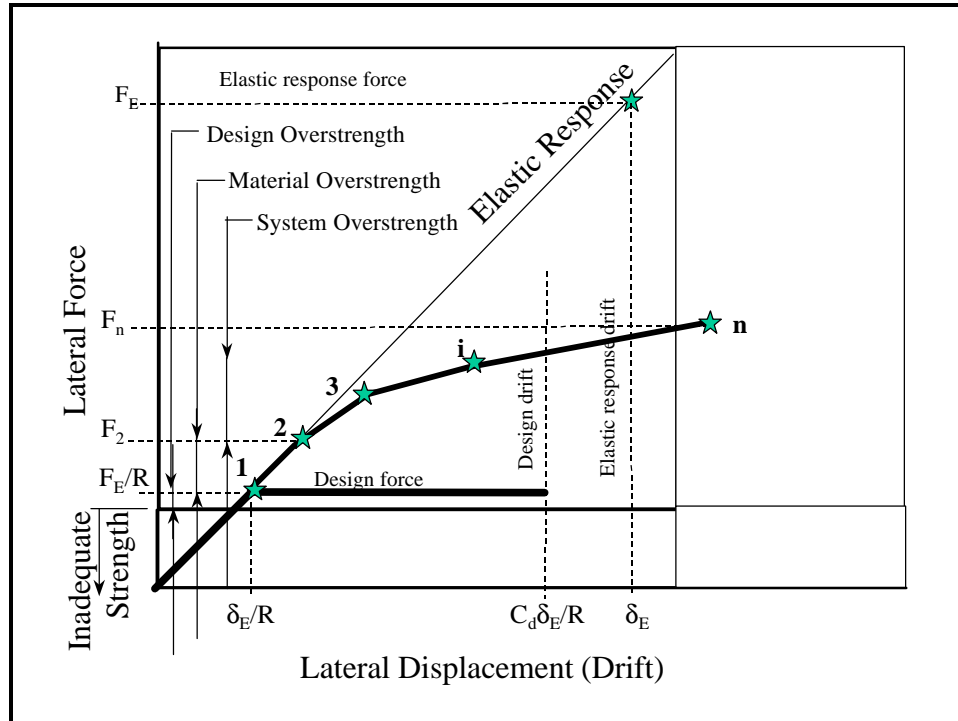

FIGURE C5.2.7 Factors affecting overstrength.

Drift controlled systems such as moment frames, however, will have substantially larger design overstrengths since it will be necessary to oversize the sections of such structures in order to keep the lateral drifts within prescribed limits. In a recent study of a number of special moment resisting steel frames conducted by the SAC Joint Venture design overstrengths on the order of a factor of two to three were found to exist (*Analytical Investigation of Buildings Affected by the 1994 Northridge Earthquake, Volumes 1 and 2*, SAC 95-04A and B. SAC Joint Venture, Sacramento, CA, 1995). Design overstrength is also potentially regionally dependent. The SAC study was conducted for frames in Seismic Design Category D and E, which represent the most severe design conditions. For structures in Seismic Design Categories A, B and C, seismic force resistance would play a less significant role in the sizing of frame elements to control drifts, and consequently, design overstrengths for these systems would be somewhat lower. It seems reasonable to assume that this portion of the design overstrength for special moment frame structures is on the order of 2.0.

Architectural design considerations have the potential to play a significant role in design overstrength. Some architectural designs will incorporate many more and larger lateral force resisting elements than are required to meet the strength and drift limitations of the code. An example of this are warehouse type structures, wherein the massive perimeter walls of the structure can provide very large lateral strength. However, even in such structures, there is typically some limiting element, such as the diaphragm, that prevents the design overstrength from becoming uncontrollably large. Thus, although the warehouse structure may have very large lateral resistance in its shear walls, typically the roof diaphragm will have a lateral force resisting capacity comparable to that specified as a minimum by the *Provisions*.

Finally, the structural designer can affect the design overstrength. While some designers seek to optimize their structures with regard to the limitations contained in the *Provisions*, others will seek to

intentionally provide greater strength and drift control than required. Typically design overstrength intentionally introduced by the designer will be on the order of 10 percent of the minimum required strength, but it may range as high as 50 to 100 percent in some cases. A factor of 1.2 should probably be presumed for this portion of the design overstrength to include the effects of both architectural and structural design overstrength. Designers who intentionally provide greater design overstrength should keep in mind that the  $W_o$  factors used in their designs should be adjusted accordingly.

Material overstrength ( $\gamma_M$ ) results from the fact that the design values used to proportion the elements of a structure are specified by the *Provisions* to be conservative lower bound estimates of the actual probable strengths of the structural materials and their effective strengths in the as-constructed structure. It is represented in the figure by the ratio of  $F_2/F_1$ , where  $F_2$  and  $F_1$  are respectively the lateral force at points 2 and 1 on the curve. All structural materials have considerable variation in the strengths that can be obtained in given samples of the material from a specific grade. The design requirements typically base proportioning requirements on minimum specified values that are further reduced through strength reduction ( $\phi$ ) factors. The actual expected strength of the as-constructed structure is significantly higher than this design value and should be calculated using the mean strength of the material, based on statistical data, by removal of the  $\phi$  factor from the design equation, and by providing an allowance for strain hardening, where significant yielding is expected to occur. Code requirements for reinforced masonry, concrete and steel have historically used a factor of 1.25 to account for the ratio of mean to specified strength and the effects of strain hardening. Considering a typical capacity reduction factor on the order of 0.9, this would indicate that the material overstrength for systems constructed of these materials would be on the order of  $1.25/0.9$ , or 1.4.

System overstrength ( $\gamma_s$ ) is the ratio of the ultimate lateral force the structure is capable of resisting,  $F_n$  in the figure, to the actual force at which first significant yield occurs,  $F_2$  in the figure. It is dependent on the amount of redundancy contained in the structure as well as the extent to which the designer has optimized the various elements that participate in lateral force resistance. For structures, with a single lateral force resisting element, such as a braced frame structure with a single bay of bracing, the system overstrength ( $\gamma_s$ ) factor would be 1.0, since once the brace in the frame yields, the system becomes fully yielded. For structures that have a number of elements participating in lateral seismic force resistance, whether or not actually intended to do so, the system overstrength will be significantly larger than this, unless the designer has intentionally optimized the structure such that a complete sidesway mechanism develops at the level of lateral drift at which the first actual yield occurs.

Structural optimization is most likely to occur in structures where the actual lateral force resistance is dominated by the design of elements intended to participate as part of the lateral-force-resisting system, and where the design of those elements is dominated by seismic loads, as opposed to gravity loads. This would include concentric braced frames and eccentric braced frames in all Seismic Design Categories and Special Moment Frames in Seismic Design Categories D and E. For such structures, the system overstrength may be taken on the order of 1.1. For dual system structures, the system overstrength is set by the *Provisions* at an approximate minimum value of 1.25. For structures where the number of elements that actually resist lateral forces is based on other than seismic design considerations, the system overstrength may be somewhat larger. In light framed residential construction, for example, the number of walls is controlled by architectural rather than seismic design consideration. Such structures may have a system overstrength on the order of 1.5. Moment frames, the design of which is dominated by gravity load considerations can easily have a system overstrength

of 2.0 or more. This affect is somewhat balanced by the fact that such frames will have a lower design overstrength related to the requirement to increase section sizes to obtain drift control. Table C5.2.7-1 presents some possible ranges of values for the various components of overstrength for various structural systems as well as the overall range of values that may occur for typical structures.

**Table C5.2.7-1 Typical Range of Overstrength for Various Systems**

Structural System	Design Overstrength D	Material Overstrength M	System Overstrength S	$\rho$
Special Moment Frames Steel & Concrete	1.5-2.5	1.2-1.6	1.0-1.5	2-3.5
Intermediate Moment Frames Steel & Concrete	1.0-2.0	1.2-1.6	1.0-2.0	2-3.5
Ordinary Moment Frames Steel & Concrete	1.0-1.5	1.2-1.6	1.5-2.5	2-3.5
Masonry Wall Frames	1.0-2.0	1.2-1.6	1.0-1.5	2-2.5
Braced Frames	1.5-2.0	1.2-1.6	1.0-1.5	1.5-2
Reinforced Bearing Wall	1.0-1.5	1.2-1.6	1.0-1.5	1.5-2.5
Reinforced Infill Wall	1.0-1.5	1.2-1.6	1.0-1.5	1.5-2.5
Unreinforced Bearing Wall	1.0-2.0	0.8-2.0	1.0-2.0	2-3
Unreinforced Infill Wall	1.0-2.0	0.8-2.0	1.0-2.0	2-3
Dual System Bracing & Frame	1.1-1.75	1.2-1.6	1.0-1.5	1.5-2.5
Light Bearing Wall Systems	1.0-0.5	1.2-2.0	1.0-2.0	2.5-3.5

In recognition of the fact that it is difficult to accurately estimate the amount of overstrength a structure will have, based solely on the type of seismic-force-resisting system that is present, in lieu of using the values of the overstrength coefficient  $\rho$  provided in Table 5.2.2, designers are encouraged to base the maximum forces used in Eqs. 5.2.7.3 and 5.2.7.4 on the results of a suitable nonlinear analysis of the structure. Such analyses should use the actual expected, rather than specified values, of material and section properties. Appropriate forms of such analyses could include a plastic mechanism analysis, a static pushover analysis or a nonlinear time history analysis. If a plastic mechanism analysis is utilized, the maximum seismic force that ever could be produced in the structure, regardless of the ground motion experienced is, estimated. If static pushover or nonlinear time history analyses are utilized, the forces utilized for design as the maximum force, should probably be that determined for Maximum Considered Earthquake level ground shaking demands.

While overstrength can be quite beneficial in permitting structures to resist actual seismic demands that are larger than those for which they have been specifically designed, it is not always beneficial. Some elements incorporated in structures behave in a brittle manner and can fail in an abrupt manner if substantially overloaded. The existence of structural overstrength results in a condition where such overloads are likely to occur, unless they are specifically accounted for in the design process. This is the purpose of Eq. 5.2.7-3 and 5.2.7-4.

One case where structural overstrength should specifically be considered is in the design of column elements beneath discontinuous braced frames and shear walls, such as occurs at vertical in-plane and out-of-plane irregularities. Overstrength in the braced frames and shear walls could cause buckling

failure of such columns with resulting structural collapse. Columns subjected to tensile loading in which splices are made using partial penetration groove welds, a type of joint subject to brittle fracture when overloaded, are another example of a case where these special load combinations should be used. Other design situations that warrant the use of these equations are noted throughout the *Provisions*.

Although the *Provisions* note the most common cases in which structural overstrength can lead to an undesirable failure mode, it is not possible for them to note all such conditions. Therefore, designers using the *Provisions* should be alert for conditions where the isolated independent failure of any element can lead to a condition of instability or collapse and should use the special load combinations of Eq. 5.6.2-3 and 5.2.7-4 for the design of these elements. Other conditions which may warrant such a design approach, although not specifically noted in the *Provisions*, include the design of transfer structures beneath discontinuous lateral force resisting elements; and the design of diaphragm force collectors to shear walls and braced frames, when these are the only method of transferring force to these elements at a diaphragm level.

**5.2.8 DEFLECTION AND DRIFT LIMITS:** This section provides procedures for the limitation of story drift. The term "drift" has two connotations:

1. "Story drift" is the maximum lateral displacement within a story (i.e., the displacement of one floor relative to the floor below caused by the effects of seismic loads).
2. The lateral displacement or deflection due to design forces is the absolute displacement of any point in the structure relative to the base. This is not "story drift" and is not to be used for drift control or stability considerations since it may give a false impression of the effects in critical stories. However, it is important when considering seismic separation requirements.

There are many reasons for controlling drift; one is to control member inelastic strain. Although use of drift limitations is an imprecise and highly variable way of controlling strain, this is balanced by the current state of knowledge of what the strain limitations should be.

Stability considerations dictate that flexibility be controlled. The stability of members under elastic and inelastic deformation caused by earthquakes is a direct function of both axial loading and bending of members. A stability problem is resolved by limiting the drift on the vertical load carrying elements and the resulting secondary moment from this axial load and deflection (frequently called the *P*-delta effect). Under small lateral deformations, secondary stresses are normally within tolerable limits. However, larger deformations with heavy vertical loads can lead to significant secondary moments from the *P*-delta effects in the design. The drift limits indirectly provide upper bounds for these effects.

Buildings subjected to earthquakes need drift control to restrict damage to partitions, shaft and stair enclosures, glass, and other fragile nonstructural elements and, more importantly, to minimize differential movement demands on the seismic safety elements. Since general damage control for economic reasons is not a goal of this document and since the state of the art is not well developed in this area, the drift limits have been established without regard to considerations such as present worth of future repairs versus additional structural costs to limit drift. These are matters for building owners and designers to examine. To the extent that life might be excessively threatened, general nonstructural damage to nonstructural and seismic safety elements is a drift limit consideration.

The design story drift limits of Table 5.2.8. reflect consensus judgment taking into account the goals of drift control outlined above. In terms of life safety and damage control objectives, the drift limits should yield a substantial, though not absolute, measure of safety for well detailed and constructed

brittle elements and provide tolerable limits wherein the seismic safety elements can successfully perform, provided they are designed and constructed in accordance with these *Provisions*.

To provide a higher performance standard, the drift limit for the essential facilities of Seismic Use Group III is more stringent than the limit for Groups I and II except for masonry shear wall buildings.

The drift limits for low-rise structures are relaxed somewhat provided the interior walls, partitions, ceilings, and exterior wall systems have been designed to accommodate story drifts. The type of steel building envisioned by the exception to the table would be similar to a prefabricated steel structure with metal skin. When the more liberal drift limits are used, it is recommended that special requirements be provided for the seismic safety elements to accommodate the drift.

It should be emphasized that the drift limits,  $D_a$ , of Table 5.2.8. are story drifts and, therefore, are applicable to each story (i.e., they must not be exceeded in any story even though the drift in other stories may be well below the limit.) The limit,  $D_a$  is to be compared to the design story drift as determined by Sec. 5.3.8.1.

Stress or strength limitations imposed by design level forces occasionally may provide adequate drift control. However, it is expected that the design of moment resisting frames, especially steel building frames, and the design of tall, narrow shear wall or braced frame buildings will be governed at least in part by drift considerations. In areas having large design spectral response accelerations,  $S_{DS}$  and  $S_{DI}$ , it is expected that seismic drift considerations will predominate for buildings of medium height. In areas having a low design spectral response accelerations and for very tall buildings in areas with large design spectral response accelerations, wind considerations generally will control, at least in the lower stories.

Due to probable first mode drift contributions, the Sec. 5.3 ELF procedure may be too conservative for drift design of very tall moment-frame buildings. It is suggested for these buildings, where the first mode would be responding in the constant displacement region of a response spectra (where displacements would be essentially independent of stiffness), that the modal analysis procedure of Sec. 5.4 be used for design even when not required by Sec. 5.2.4.

Building separations and seismic joints are separations between two adjoining buildings or parts of the same building, with or without frangible closures, for the purpose of permitting the adjoining buildings or parts to respond independently to earthquake ground motion. Unless all portions of the structure have been designed and constructed to act as a unit, they must be separated by seismic joints. For irregular structures that cannot be expected to act reliably as a unit, seismic joints should be utilized to separate the building into units whose independent response to earthquake ground motion can be predicted.

Although the *Provisions* do not give precise formulations for the separations, it is required that the distance be "sufficient to avoid damaging contact under total deflection" in order to avoid interference and possible destructive hammering between buildings. It is recommended that the distance be equal to the total of the lateral deflections of the two units assumed deflecting toward each other (this involves increasing separations with height). If the effects of hammering can be shown not to be detrimental, these distances can be reduced. For very rigid shear wall structures with rigid diaphragms whose lateral deflections cannot be reasonably estimated, it is suggested that older code requirements for structural separations of at least 1 in. (25 mm) plus 1/2 in. (13 mm) for each 10 ft (3 m) of height above 20 ft (6 m) be followed.

### **5.3 EQUIVALENT LATERAL FORCE PROCEDURE:**

---



**5.3.1 General:** This section discusses the equivalent lateral force (ELF) procedure for seismic analysis of structures.

**5.3.2 Seismic Base Shear:** The heart of the ELF procedure is Eq. 5.3.2.-1 for base shear, which gives the total seismic design force,  $V$ , in terms of two factors: a seismic response coefficient,  $C_s$ , and the total gravity load of the building,  $W$ . The seismic response coefficient  $C_s$ , is obtained from Eq. 5.3.2..1-1 and 5.3.2..1-2 based on the design spectral response accelerations,  $S_{DS}$  and  $S_{D1}$ . These acceleration parameters and the derivation of the response spectrum is discussed more fully in the *Commentary* for Chapter 4.

The gravity load  $W$  is the total weight of the building and that part of the service load that might reasonably be expected to be attached to the building at the time of an earthquake. It includes permanent and movable partitions and permanent equipment such as mechanical and electrical equipment, piping, and ceilings. The normal human live load is taken to be negligibly small in its contribution to the seismic lateral forces. Buildings designed for storage or warehouse usage should have at least 25 percent of the design floor live load included in the weight,  $W$ . Snow loads up to 30 psf (1400 Pa) are not considered. Freshly fallen snow would have little effect on the lateral force in an earthquake; however, ice loading would be more or less firmly attached to the roof of the building and would contribute significantly to the inertia force. For this reason, the effective snow load is taken as the full snow load for those regions where the snow load exceeds 30 psf with the proviso that the local authority having jurisdiction may allow the snow load to be reduced up to 80 percent. The question of how much snow load should be included in  $W$  is really a question of how much ice buildup or snow entrapment can be expected for the roof configuration or site topography, and this is a question best left to the discretion of the local authority having jurisdiction.

The base shear formula and the various factors contained therein were arrived at as explained below.

*Elastic Acceleration Response Spectra:* See the *Commentary* for Chapter 4 for a full discussion of the shape of the spectra accounting for dynamic response amplification and the effect of site response.

*Elastic Design Spectra:* The elastic acceleration response spectra for earthquake motions has a descending branch for longer values of  $T$ , the period of vibration of the system, that varies roughly as  $1/T$ . In previous editions of the *Provisions*, the actual response spectra that varied in a  $1/T$  relationship were replaced with design spectra that varied in a  $1/T^{2/3}$  relationship. This was intentionally done to provide added conservatism in the design of tall structures. In the development of the 1997 *Provisions*, a special task force, known as the Seismic Design Procedures Group (SDPG), was convened to develop a method for using new seismic hazard maps, developed by the USGS in the *Provisions*. Whereas older seismic hazard maps provided an effective peak ground acceleration coefficient  $C_a$  and an effective peak velocity related acceleration coefficient  $C_v$ , the new maps directly provide parameters that correspond to points on the response spectrum. It was the recommendation of the SDPG that the true shape of the response spectrum, represented by a  $1/T$  relationship, be maintained in the base shear equation. In order to maintain the added conservatism for tall and high occupancy structures, formerly provided by the design spectra which utilized a  $1/T^{2/3}$  relationship, the 1997 *Provisions* adopted an occupancy importance factor  $I$  into the base shear equation. This  $I$  factor, which has a value of 1.25 for Seismic Use Group II structures and 1.5 for Seismic Use Group III structures has the effect of raising the design spectrum for taller, high occupancy structures, to levels comparable to those for which they were designed in previous editions of the *Provisions*.

**Response Modification Factor:** The factor  $R$  in the denominator of Eq. 5.3.2.1-1 is an empirical response reduction factor intended to account for both damping and the ductility inherent in the structural system at displacements great enough to surpass initial yield and approach the ultimate load displacement of the structural system. Thus, for a lightly damped building structure of brittle material that would be unable to tolerate any appreciable deformation beyond the elastic range, the factor  $R$  would be close to 1 (i.e., no reduction from the linear elastic response would be allowed). At the other extreme, a heavily damped building structure with a very ductile structural system would be able to withstand deformations considerably in excess of initial yield and would, therefore, justify the assignment of a larger response reduction factor  $R$ . Table 5.2.2 in the *Provisions* stipulates  $R$  coefficients for different types of building systems using several different structural materials. The coefficient  $R$  ranges in value from a minimum of 1-1/4 for an unreinforced masonry bearing wall system to a maximum of 8 for a special moment frame system. The basis for the  $R$  factor values specified in Table 5.2.2 is explained in the Sec. 5.2.1.

The effective value of  $R$  used in the base shear equation is adjusted by the occupancy importance factor  $I$ . The  $I$  value, which ranges from 1 to 1.5, has the effect of reducing the amount of ductility the structure will be called on to provide at a given level of ground shaking. However, it must be recognized that added strength, by itself, is not adequate to provide for superior seismic performance in buildings with critical occupancies. Good connections and construction details, quality assurance procedures, and limitations on building deformation or drift are also important to significantly improve the capability for maintenance of function and safety in critical facilities and those with a high-density occupancy. Consequently, the reduction in the damage potential of critical facilities (Group III) is also handled by using more conservative drift controls (Sec. 5.2.8.) and by providing special design and detailing requirements (Sec. 5.2.6) and materials limitations (Chapters 8 through 12).

**5.3.3 Period Determination:** In the denominator of Eq. 5.3.2.1-2,  $T$  is the fundamental period of vibration of the building. It is preferable that this be determined using modal analysis methods and the principals of structural mechanics. However, methods of structural mechanics cannot be employed to calculate the vibration period before a building has been designed. Consequently, this section provides an approximate method that can be used to estimate building period, with minimal information available on the building design. It is based on the use of simple formulas that involve only a general description of the building type (e.g., steel moment frame, concrete moment frame, shear wall system, braced frame) and overall dimensions (e.g., height and plan length) to estimate the vibration period in order to calculate an initial base shear and proceed with a preliminary design. It is advisable that this base shear and the corresponding value of  $T$  be conservative. Even for final design, use of a large value for  $T$  is unconservative. Thus, the value of  $T$  used in design should be smaller than the true period of the building. Equations 5.3.3.1-1 and 5.3.3.1-2 for the approximate period  $T_a$  are therefore intended to provide conservative estimates of the fundamental period of vibration. An upper bound is placed on the value of  $T$  calculated using more exact methods, based on  $T_a$  and the factor  $C_u$ . The coefficient  $C_u$  accommodates the probable fact that buildings in areas with lower lateral force requirements probably will be more flexible. Furthermore, it results in less dramatic changes from present practice in lower risk areas. It is generally accepted that the *empirical* equations for  $T_a$  are tailored to fit the type of construction common in areas with high lateral force requirements. It is unlikely that buildings in lower risk seismic areas would be designed to produce as high a drift level as allowed in the *Provisions* due to stability problems ( $P$ -delta) and wind requirements. For buildings whose design are actually

"controlled" by wind, the use of a large  $T$  will not really result in a lower design force; thus, use of this approach in high-wind regions should not result in unsafe design.

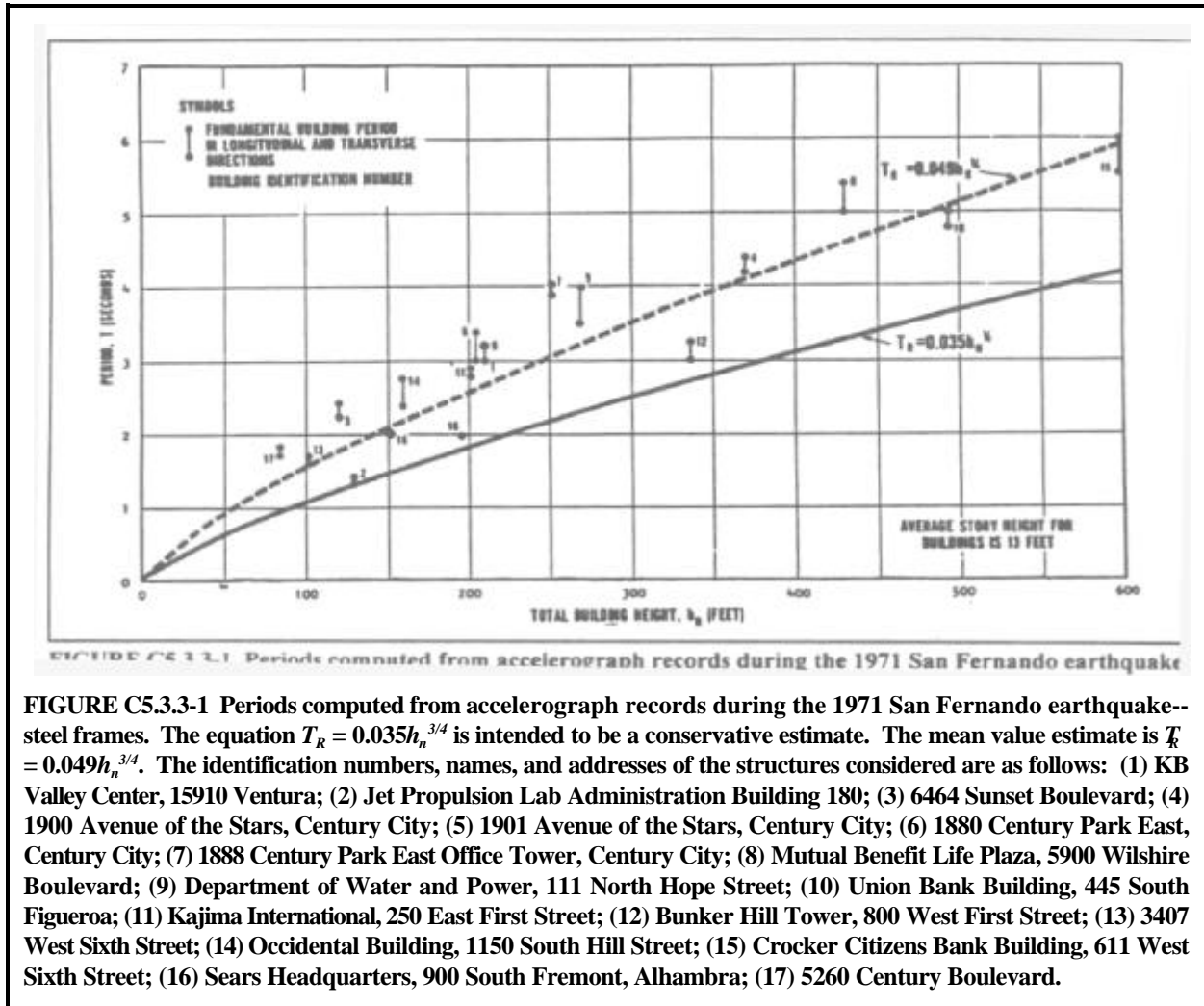

Taking the seismic base shear to vary as  $1/T$  and assuming that the lateral forces are distributed linearly over the height and the deflections are controlled by drift limitations, a simple analysis of the vibration period by Rayleigh's method (Clough and Penzien, 1975; Newmark and Rosenblueth, 1971; Thomson, 1965; Wiegel, 1970) leads to the conclusion that the vibration period of moment resisting frame structures varies roughly as  $h_n^{3/4}$  where  $h_n$  equals the total height of the building as defined elsewhere. Equation 5.3.3.1-1 is therefore appropriate and the values of the coefficient  $C_T$  have been established to produce values for  $T_a$  generally lower than the true fundamental vibration period of moment frame buildings. This is apparent in Figures C5.3.3-1 and C5.3.3-2. In these figures, Eq. 5.3.3.1-1 is compared with fundamental vibration periods computed from accelerograph records from

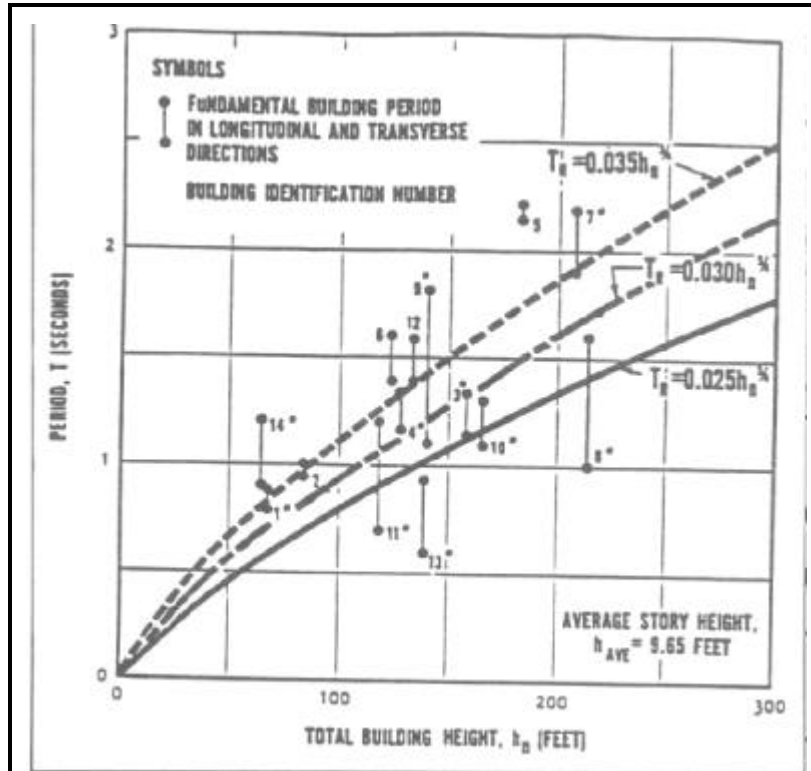
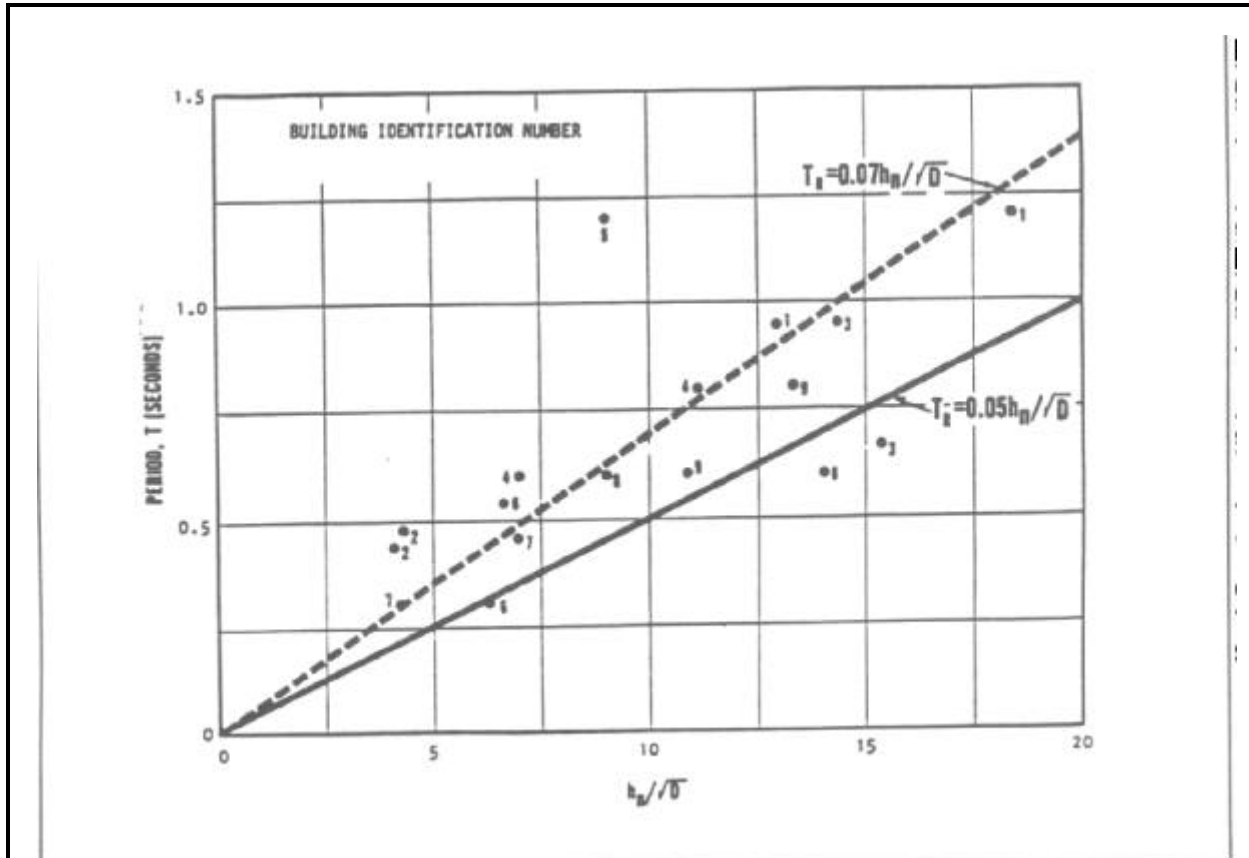

FIGURE C5.3.2-2 Periods computed from accelerograph records during the 1971 San Fernando earthquake--reinforced concrete frames. The equation  $T_R = 0.030h_n^{3/4}$  is intended to be a conservative estimate. The mean value estimate is  $T_R = 0.035h_n^{3/4}$ . The identification numbers, names, and addresses of the structures considered are as follows: (1) Holiday Inn, 8244 Orion Street; (2) Valley Presbyterian Hospital, 15107 Vanowen Boulevard; (3) Bank of California, 15250 Ventura Boulevard; (4) Hilton Hotel, 15433 Ventura Boulevard; (5) Sheraton-Universal, 3838 Lankership Boulevard; (6) Muir Medical center, 7080 Hollywood Boulevard; (7) Holiday Inn, 1760 North Orchid; (8) 1800 Century Park East, Century City; (9) Wilshire Christian Towers, 616 South Normandie Avenue; (10) Wilshire Square One, 3345 Wilshire Boulevard; (11) 533 South Fremont; (12) Mohn Olympic, 1625 Olympic Boulevard; (13) 120 Robertson; (14) Holiday Inn, 1640 Marengo. Incomplete study data have suggested that Buildings 1, 3, 4, 7, 8, 9, 10, 11, 13, and 14 may not act as true frames; these numbers are marked with an asterisk.

upper stories of several buildings during the 1971 San Fernando earthquake. The optional use of  $T = 0.1N$  (Eq. 5.3.3.1-2) is an approximation for low to moderate height frames that has been long in use.

As an exception to Eq. 5.3.3.1-1, these requirements allow the calculated fundamental period of vibration,  $T$ , of the seismic-force-resisting system to be used in calculating the base shear. However, the period,  $T$ , used may not exceed  $C_u T_a$  with  $T_a$  determined from Eq. 5.3.3.1-1.



**FIGURE C5.3.3-3** Periods computed from accelerograph records during the 1971 San Fernando earthquake--reinforced concrete shear wall buildings. The equation  $T_r = 0.05h_n/D$  is intended to be a conservative estimate for all buildings other than steel frames and reinforced concrete frames. The mean value estimate is  $T_i = 0.07h_n/D$ . The identification numbers, names, and addresses of the buildings considered are as follows: (1) Certified Life, 14724 Ventura Boulevard; (2) Kaiser Foundation hospital, 4867 Sunset Boulevard; (3) Millikan Library, Cal Tech, Pasadena; (4) 1888 Century Park East, Century City; (5) 3470 Wilshire Boulevard; (6) Los Angeles Athletic Club Parking Structure, 646 South Olive; (7) Parking Structure, 808 South Olive; (8) USC Medical Center, 2011 Zonal; (9) Airport Marina Hotel, 8639 Lincoln, Marina Del Ray.

For exceptionally stiff or light buildings, the calculated  $T$  for the seismic-force-resisting system may be significantly shorter than  $T_a$  calculated by Eq. 5.3.3.1-1. For such buildings, it is recommended that the period value  $T$  be used in lieu of  $T_a$  for calculating the seismic response coefficient,  $C_s$ .

Although the approximate methods of Section 3.3.3. can be used to determine a period for the design of structures, the fundamental period of vibration of the seismic-force-resisting system should be calculated according to established methods of mechanics. Computer programs are available for such calculations. One method of calculating the period, probably as convenient as any, is the use of the following formula based on Rayleigh's method (Clough and Penzien, 1975; Newmark and Rosenblueth, 1971; Thomson, 1965; Wiegel, 1970):

$$T = 2 \sqrt{\frac{\sum_{i=1}^n w_i^2 d_i^2}{g \sum_{i=1}^n F_i d_i}} \quad (\text{C5.3.3})$$

where:

- $F_i$  = the seismic lateral force at Level  $i$ ,
- $w_i$  = the gravity load assigned in Level  $i$ ,
- $d_i$  = the static lateral displacement at Level  $i$  due to the forces  $F_i$  computed on a linear elastic basis, and
- $g$  = is the acceleration of gravity.

The calculated period increases with an increase in flexibility of the structure because the  $\delta$  term in the Rayleigh formula appears to the second power in the numerator but to only the first power in the denominator. Thus, if one ignores the contribution of nonstructural elements to the stiffness of the structure in calculating the deflections  $\delta$ , the deflections are exaggerated and the calculated period is lengthened, leading to a decrease in the seismic response coefficient  $C_s$  and, therefore, a decrease in the design force. Nonstructural elements do not know that they are nonstructural. They participate in the behavior of the structure even though the designer may not rely on them for contributing any strength or stiffness to the structure. To ignore them in calculating the period is to err on the unconservative side. The limitation of  $C_u T_a$  is imposed as a safeguard.

**5.3.4 Vertical Distribution of Seismic Forces:** The distribution of lateral forces over the height of a structure is generally quite complex because these forces are the result of superposition of a number of natural modes of vibration. The relative contributions of these vibration modes to the total forces depends on a number of factors including the shape of the earthquake response spectrum, the natural periods of vibration of the structure, and the shapes of vibration modes that, in turn, depend on the mass and stiffness over the height (see Sec. 5.2.3). The basis of this method is discussed below. In structures having only minor irregularity of mass or stiffness over the height, the accuracy of the lateral force distribution as given by Eq. 5.3.4-2 is much improved by the procedure described in the last portion of Sec. 5.2.4 of this commentary. The lateral force at each level,  $x$ , due to response in the first (fundamental) natural mode of vibration is:

$$f_{xI} = V_1 \left( \frac{w_x \phi_{xI}}{\sum_{i=1}^n w_i \phi_{iI}} \right) \quad (\text{C5.3.4})$$

where:

$V_1$  = the contribution of this mode to the base shear,

$w_i$  = the weight lumped at the  $i$ th level, and

$\phi_i$  = the amplitude of the first mode at the  $i^{\text{th}}$  level.

This is the same as Eq. 5.4.6-2 in Sec. 5.4 of the *Provisions*, but it is specialized for the first mode. If  $V_1$  is replaced by the total base shear,  $V$ , this equation becomes identical to Eq. 5.3.4-2 with  $k = 1$  if the first mode shape is a straight line and with  $k = 2$  if the first mode shape is a parabola with its vertex at the base.

It is well known that the influence of modes of vibration higher than the fundamental mode is small in the earthquake response of short period structures and that, in regular structures, the fundamental vibration mode departs little from a straight line. This, along with the matters discussed above, provides the basis for Eq. 5.3.4-2 with  $k = 1$  for structures having a fundamental vibration period of 0.5 seconds or less.

It has been demonstrated that although the earthquake response of long period structures is primarily due to the fundamental natural mode of vibration, the influence of higher modes of vibration can be significant and, in regular structures, the fundamental vibration mode lies approximately between a straight line and a parabola with the vertex at the base. Thus, Eq. 5.3.4-2 with  $k = 2$  is appropriate for structures having a fundamental period of vibration of 2.5 seconds or longer. Linear variation of  $k$  between 1 at a 0.5 second period and 2 at a 2.5 seconds period provides the simplest possible transition between the two extreme values.

**5.3.5 Horizontal Shear Distribution:** The story shear in any story is the sum of the lateral forces acting at all levels above that story. Story  $x$  is the story immediately below Level  $x$  (C5.3.5).

Reasonable and consistent assumptions regarding the stiffness of concrete and masonry elements may be used for analysis in distributing the shear force to such elements connected by a horizontal diaphragm. Similarly, the stiffness of moment or braced frames will establish the distribution of the story shear to the vertical resisting elements in that story.

**5.3.5.1 Torsion:** The torsional moment to be considered in the design of elements in a story consists of two parts:

1.  $M_p$ , the moment due to eccentricity between centers of mass and resistance for that story, is to be computed as the story shear times the eccentricity perpendicular to the direction of applied earthquake forces.
2.  $M_{\omega}$ , commonly referred to as "accidental torsion," is to be computed as the story shear times the "accidental eccentricity," equal to 5 percent of the dimension of the structure, in the story under consideration perpendicular to the direction of the applied earthquake forces.

Computation of  $M_{ta}$  in this manner is equivalent to the procedure in Sec. 5.3.5 which implies that the dimension of the structure is the dimension in the story where the torsional moment is being computed and that all the masses above that story should be assumed to be displaced in the same direction at one time (e.g., first, all of them to the left and, then, to the right).

Dynamic analyses assuming linear behavior indicate that the torsional moment due to eccentricity between centers of mass and resistance may significantly exceed  $M_t$  (Newmark and Rosenblueth, 1971). However, such dynamic magnification is not included in the *Provisions*, partly because its significance is not well understood for structures designed to deform well beyond the range of linear behavior.

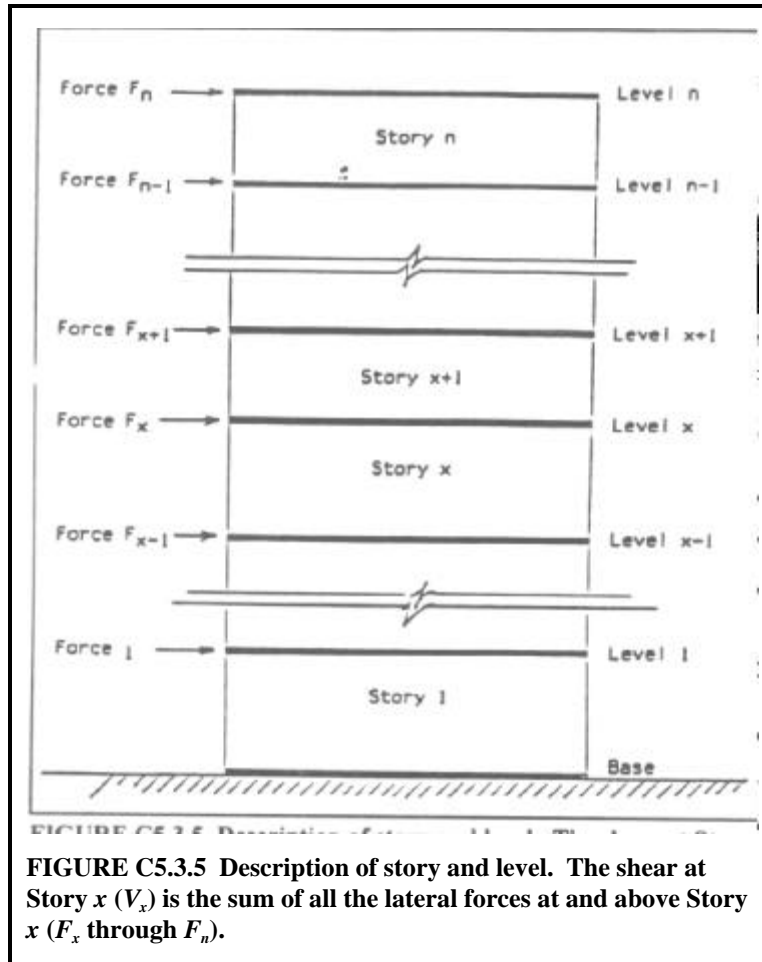

The torsional moment  $M_t$  calculated in accordance with this provision would be zero in those stories where centers of mass and resistance coincide. However, during vibration of the structure, torsional moments would be induced in such stories due to eccentricities between centers of mass and resistance in other stories. To account for such effects, it is recommended that the torsional moment in any story be not smaller than the following two values (Newmark and Rosenblueth, 1971):

1. The story shear times one-half of the maximum of the computed eccentricities in all stories below the one being analyzed and
2. One-half of the maximum of the computed torsional moments for all stories above.



Accidental torsion is intended to cover the effects of several factors that have not been explicitly considered in the *Provisions*. These factors include the rotational component of ground motion about a vertical axis; unforeseeable differences between computed and actual values of stiffness, yield strengths, and dead-load masses; and unforeseeable unfavorable distributions of dead- and live-load masses.

There are indications that the 5 percent accidental eccentricity may be too small in some structures since they may develop torsional dynamic instability. Some examples are the upper stories of tall structures having little or no nominal eccentricity, those structures where the calculations of relative stiffnesses of various elements are particularly uncertain (e.g., those that depend largely on masonry walls for lateral force resistance or those that depend on vertical elements made of different materials), and nominally symmetrical structures that utilize core elements alone for seismic resistance or that behave essentially like elastic nonlinear systems (e.g., some prestressed concrete frames). The amplification factor for torsionally irregular structures (Eq. 5.3.5.1) was introduced in the 1988 Edition as an attempt to account for some of these problems in a controlled and rational way.

The way in which the story shears and the effects of torsional moments are distributed to the vertical elements of the seismic-force-resisting system depends on the stiffness of the diaphragms relative to vertical elements of the system.

Where the diaphragm stiffness in its own plane is sufficiently high relative to the stiffness of the vertical components of the system, the diaphragm may be assumed to be indefinitely rigid for purposes of this section. Then, in accordance with compatibility and equilibrium requirements, the shear in any story is to be distributed among the vertical components in proportion to their contributions to the lateral stiffness of the story while the story torsional moment produces additional shears in these components that are proportional to their contributions to the torsional stiffness of the story about its center of resistance. This contribution of any component is the product of its lateral stiffness and the square of its distance to the center of resistance of the story. Alternatively, the story shears and torsional moments may be distributed on the basis of a three-dimensional analysis of the structure, consistent with the assumption of linear behavior.

Where the diaphragm in its own plane is very flexible relative to the vertical components, each vertical component acts almost independently of the rest. The story shear should be distributed to the vertical components considering these to be rigid supports. Analysis of the diaphragm acting as a continuous horizontal beam or truss on rigid supports leads to the distribution of shears. Because the properties of the beam or truss may not be accurately computed, the shears in vertical elements should not be taken to be less than those based on "tributary areas." Accidental torsion may be accounted for by adjusting the position of the horizontal force with respect to the supporting vertical elements.

There are some common situations where it is obvious that the diaphragm can be assumed to be either rigid or very flexible in its own plane for purposes of distributing story shear and considering torsional moments. For example, a solid monolithic reinforced concrete slab, square or nearly square in plan, in a structure with slender moment resisting frames may be regarded as rigid. A large plywood diaphragm with widely spaced and long, low masonry walls may be regarded as very flexible. In intermediate situations, the design forces should be based on an analysis that explicitly considers diaphragm deformations and satisfies equilibrium and compatibility requirements. Alternatively, the design forces should be the envelope of the two sets of forces resulting from both extreme assumptions regarding the diaphragms--rigid or very flexible.

Where the horizontal diaphragm is not continuous, the story shear can be distributed to the vertical components based on their tributary areas.

**5.3.6 Overtuning:** This section requires that the structure be designed to resist overturning moments statically consistent with the design story shears, except for reduction factor  $\alpha$  in Eq. 5.3.6. There are several reasons for reducing the statically computed overturning moments:

1. The distribution of design story shears over height computed from the lateral forces of Sec. 5.3.2 is intended to provide an envelope since the shears in all stories do not attain their maximum simultaneously. Thus, the overturning moments computed statically from the envelope of story shears will be overestimated.
2. It is intended that the design shear envelope, which is based on the simple distribution of forces specified in Sec. 5.3.4, be conservative. If the shear in a specific story is close to the exact value, the shears in almost all other stories are almost necessarily overestimated. Hence, the overturning moments statically consistent with the design story shears will be overestimated.
3. Under the action of overturning moments, one edge of the foundation may lift from the ground for short durations of time. Such behavior leads to substantial reduction in the seismic forces and, consequently, in the overturning moments.

The overturning moments computed statically from the envelope of story shears may be reduced by no more than 20 percent. This value is similar to those obtained from results of dynamic analysis taking into account the first two reasons presented above. No reduction is permitted in the uppermost 10 stories primarily because the statically computed overturning moment in these stories may err on the unsafe side (Newmark and Rosenblueth, 1971). In any case, there is hardly any benefit in reducing the overturning moments in the stories near the top of structures because design of vertical elements in these stories is rarely governed by overturning moments. For the eleventh to the twentieth stories from the top, linear variation of  $\alpha$  provides the simplest transition between the minimum and maximum values of 0.8 and 1.0.

In the design of the foundation, the overturning moment may be calculated at the foundation-soil interface using Eq. 5.3.6 with  $\alpha = 0.75$  for structures of all heights. This is appropriate because a slight uplifting of one edge of the foundation during vibration leads to reduction in the overturning moment and because such behavior does not normally cause structural distress.

Formerly, many building codes and design recommendations allowed more drastic reduction in overturning moments relative to their value statically consistent with the design story shears. These reductions appeared to be excessive in light of the damage to structures during the 1967 Caracas earthquake where a number of column failures were due primarily to effects of overturning moment. In later versions of the SEAOC recommendations (1973), no reduction was allowed. The moderate reduction permitted in Sec. 5.3.6, which is consistent with results of dynamic analyses (Newmark and Rosenblueth, 1971), is more appropriate because use of the full statically determined overturning moment cannot be justified in light of the reasons mentioned above.

**5.3.7 Drift Determination and *P*-delta Effects:** This section defines the design story drift as the difference of the deflections,  $\Delta_{sp}$ , at the top and bottom of the story under consideration. The deflections,  $\Delta_{se}$ , are determined by multiplying the deflections,  $\Delta_{xe}$  (determined from an elastic analysis), by the deflection amplification factor,  $C_{d\beta}$ , given in Table 5.2.2. The elastic analysis is to be made for the seismic-force-resisting system using the prescribed seismic design forces and considering the

structure to be fixed at the base. Stiffnesses other than those of the seismic-force-resisting system should not be included since they may not be reliable at higher inelastic strain levels.

The deflections are to be determined by combining the effects of joint rotation of members, shear deformations between floors, the axial deformations of the overall lateral resisting elements, and the shear and flexural deformations of shear walls and braced frames. The deflections are determined initially on the basis of the distribution of lateral forces stipulated in Sec. 5.3.4. For frame structures, the axial deformations from bending effects, although contributing to the overall structural distortion, may or may not affect the story-to-story drift; however, they are to be considered. Centerline dimensions between the frame elements often are used for analysis, but clear span dimensions with consideration of joint panel zone deformation also may be used.

For determining compliance with the story drift limitation of Sec. 5.2.7, the deflections,  $\delta_x$ , may be calculated as indicated above for the seismic-force-resisting system and design forces corresponding to the fundamental period of the structure,  $T$  (calculated without the limit  $T \leq C_u T_a$  specified in Sec. 5.3.3), may be used. The same model of the seismic-force-resisting system used in determining the deflections must be used for determining  $T$ . The waiver does not pertain to the calculation of drifts for determining  $P$ -delta effects on member forces, overturning moments, etc. If the  $P$ -delta effects determined in Sec. 5.3.7.2 are significant, the design story drift must be increased by the resulting incremental factor.

The  $P$ -delta effects in a given story are due to the eccentricity of the gravity load above that story. If the story drift due to the lateral forces prescribed in Sec. 5.3.4 were  $\delta_x$ , the bending moments in the story would be augmented by an amount equal to  $\delta_x$  times the gravity load above the story. The ratio of the  $P$ -delta moment to the lateral force story moment is designated as a stability coefficient,  $\alpha$ , in Eq. 5.3.7.2-1. If the stability coefficient  $\alpha$  is less than 0.10 for every story, the  $P$ -delta effects on story shears and moments and member forces may be ignored. If, however, the stability coefficient exceeds 0.10 for any story, the  $P$ -delta effects on story drifts, shears, member forces, etc., for the whole structure must be determined by a rational analysis.

An acceptable  $P$ -delta analysis, based upon elastic stability theory, is as follows:

1. Compute for each story the  $P$ -delta amplification factor,  $a_d = \delta_x / (1 - \alpha \delta_x)$ .  $a_d$  takes into account the multiplier effect due to the initial story drift leading to another increment of drift that would lead to yet another increment, etc. Thus, both the effective shear in the story and the computed eccentricity would be augmented by a factor  $1 + \alpha \delta_x + \alpha^2 \delta_x^2 + \alpha^3 \delta_x^3 \dots$ , which is  $1/(1 - \alpha \delta_x)$  or  $(1 + a_d)$ .
2. Multiply the story shear,  $V_x$ , in each story by the factor  $(1 + a_d)$  for that story and recompute the story shears, overturning moments, and other seismic force effects corresponding to these augmented story shears.

This procedure is applicable to planar structures and, with some extension, to three-dimensional structures. Methods exist for incorporating two- and three-dimensional  $P$ -delta effects into computer analyses that do not explicitly include such effects (Rutenberg, 1985). Many programs explicitly include  $P$ -delta effects. A mathematical description of the method employed by several popular programs is given by Wilson and Habibullah (1987).

The  $P$ -delta procedure cited above effectively checks the static stability of a structure based on its initial stiffness. Since the inception of this procedure with ATC 3-06, however, there has been some debate regarding its accuracy. This debate stems from the intuitive notion that the structure's secant

stiffness would more accurately represent inelastic  $P$ -delta effects. Given the additional uncertainty of the effect of dynamic response on  $P$ -delta behavior and the (apparent) observation that instability-related failures rarely occur in real structures, the  $P$ -delta requirements remained as originally written until revised for the 1991 Edition.

There was increasing evidence that the use of inelastic stiffness in determining *theoretical*  $P$ -delta response is unconservative. Given a study carried out by Bernal (1987), it was argued that  $P$ -delta amplifiers should be based on secant stiffness and that, in other words, the  $C_d$  term in Eq. 5.3.7.2-1 should be deleted. However, since Bernal's study was based on the inelastic response of single-degree-of-freedom elastic-perfectly plastic systems, significant uncertainties existed regarding the extrapolation of the concepts to the complex hysteretic behavior of multi-degree-of-freedom systems.

Another problem with accepting a  $P$ -delta procedure based on secant stiffness was that design forces would be greatly increased. For example, consider an ordinary moment frame of steel with a  $C_d$  of 4.0 and an elastic stability coefficient of 0.15. The amplifier for this structure would be  $1.0/0.85 = 1.18$  according to the 1988 Edition of the *Provisions*. If the  $P$ -delta effects were based on secant stiffness, however, the stability coefficient would increase to 0.60 and the amplifier would become  $1.0/0.4 = 2.50$ . (Note that the 0.9 in the numerator of the amplifier equation in the 1988 Edition was dropped for this comparison.) This example illustrates that there could be an extreme impact on the requirements if a change was implemented that incorporated  $P$ -delta amplifiers based on static secant stiffness response.

There was, however, some justification for retaining the  $P$ -delta amplifier as based on elastic stiffness. This justification was the apparent lack of stability-related failures. The reasons for the lack of observed failures included:

1. Many structures display strength well above the strength implied by code-level design forces (see Figure C5.1.1). This overstrength likely protects structures from stability-related failures.
2. The likelihood of a stability failure decreases with increased intensity of expected ground-shaking. This is due to the fact that the stiffness of most structures designed for extreme ground motion is significantly greater than the stiffness of the same structure designed for lower intensity shaking or for wind. Since damaging low-intensity earthquakes are somewhat rare, there would be little observable damage.

Due to the lack of stability-related failures, therefore, the requirements of the 1988 Edition of the *Provisions* regarding  $P$ -delta amplifiers remain in the 1991 and 1994 Editions with the exception that the 0.90 factor in the numerator of the amplifier has been deleted. This factor originally was used to create a transition from cases where  $P$ -delta effects need not be considered ( $\leq 0.10$ , amplifier = 1.0) to cases where such effects need be considered ( $> 1.0$ , amplifier  $> 1.0$ ).

However, the 1991 Edition introduced a requirement that the computed stability coefficient,  $\beta$ , not exceed  $0.25$  or  $0.5/C_d$ , where  $C_d$  is an adjusted ductility demand that takes into account the fact that the seismic strength demand may be somewhat less than the code strength supplied. The adjusted ductility demand is not intended to incorporate overstrength beyond that computed by the means available in Chapters 8 through 14 of the *Provisions*.

The purpose of this requirement is to protect structures from the possibility of stability failures triggered by post-earthquake residual deformation. The danger of such failures is real and may not be

eliminated by apparently available overstrength. This is particularly true of structures designed in regions of lower seismicity.

The computation of  $\gamma_{max}$ , which, in turn, is based on  $C_{db}$ , requires the computation of story strength supply and story strength demand. Story strength demand is simply the seismic design shear for the story under consideration. The story strength supply may be computed as the shear in the story that occurs simultaneously with the attainment of the development of first significant yield of the overall structure. To compute first significant yield, the structure should be loaded with a seismic force pattern similar to that used to compute seismic story strength demand. A simple and conservative procedure is to compute the ratio of demand to strength for each member of the seismic-force-resisting system in a particular story and then use the largest such ratio as  $\gamma_{max}$ . For a structure otherwise in conformance with the *Provisions*,  $\gamma_{max} = 1.0$  is obviously conservative.

The principal reason for inclusion of  $\gamma_{max}$  is to allow for a more equitable analysis of those structures in which substantial extra strength is provided, whether as a result of added stiffness for drift control, from code-required wind resistance, or simply a feature of other aspects of the design.  $\gamma_{max} =$  story shear demand/story shear capacity is conservatively 1.0 for any design that meets the remainder of the *Provisions*. Some structures inherently possess more strength than required, but instability is not typically a concern for such structures. For many flexible structures, the proportions of the structural members are controlled by the drift requirements rather than the strength requirements; consequently,  $\gamma_{max}$  is less than 1.0 because the members provided are larger and stronger than required. This has the effect of reducing the inelastic component of total seismic drift and, thus,  $\gamma_{max}$  is placed as a factor on  $C_{dt}$ .

Accurate evaluation of  $\gamma_{max}$  would require consideration of all pertinent load combinations to find the maximum value of seismic load effect demand to seismic load effect capacity in each and every member. A conservative simplification is to divide the total demand with seismic included by the total capacity; this covers all load combinations in which dead and live effects add to seismic. If a member is controlled by a load combination where dead load counteracts seismic, to be correctly computed, the ratio  $\gamma_{max}$  must be based only on the seismic component, not the total; note that the vertical load  $P$  in the  $P$ -delta computation would be less in such a circumstance and, therefore,  $\gamma_{max}$  would be less. The importance of the counteracting load combination does have to be considered, but it rarely controls instability.

## 5.4 MODAL ANALYSIS PROCEDURE:

**5.4.1 General, and 5.4.2 Modeling:** Modal analysis (Newmark and Rosenblueth, 1971; Clough and Penzien, 1975; Thomson, 1965; Wiegel, 1970) is applicable for calculating the linear response of complex, multi-degree-of-freedom structures and is based on the fact that the response is the superposition of the responses of individual natural modes of vibration, each mode responding with its own particular pattern of deformation (the mode shape), with its own frequency (the modal frequency), and with its own modal damping. The response of the structure, therefore, can be modeled by the response of a number of single-degree-of-freedom oscillators with properties chosen to be representative of the mode and the degree to which the mode is excited by the earthquake motion. For certain types of damping, this representation is mathematically exact and, for structures, numerous full-scale tests and analyses of earthquake response of structures have shown that the use of modal analysis, with viscously damped single-degree-of-freedom oscillators describing the response of the structural modes, is an accurate approximation for analysis of linear response.

Modal analysis is useful in design. The Equivalent Lateral Force procedure of Sec. 5.3 is simply a first mode application of this technique, that assumes all of the structure's mass is active in the first mode. The purpose of modal analysis is to obtain the maximum response of the structure in each of its important modes, which are then summed in an appropriate manner. This maximum modal response can be expressed in several ways. For the *Provisions*, it was decided that the modal forces and their distributions over the structure should be given primary emphasis to highlight the similarity to the equivalent static methods traditionally used in building codes (the SEAOC recommendations and the *UBC*) and the ELF procedure in Sec. 5.3. Thus, the coefficient  $C_{sm}$  in Eq. 5.4.5-1 and the distribution equations, Eq. 5.4.6-1 and 5.4.6-2, are the counterparts of Eq. 5.3.4-1 and 5.3.4-2. This correspondence helps clarify the fact that the simplified modal analysis contained in Sec. 5.4 is simply an attempt to specify the equivalent lateral forces on a structure in a way that directly reflects the individual dynamic characteristics of the structure. Once the story shears and other response variables for each of the important modes are determined and combined to produce design values, the design values are used in basically the same manner as the equivalent lateral forces given in Sec. 5.3.

**5.4.3 MODES:** This section defines the number of modes to be used in the analysis. For many structures, including low-rise structures and structures of moderate height, three modes of vibration in each direction are nearly always sufficient to determine design values of the earthquake response of the structure. For high-rise structures, however, more than three modes may be required to adequately determine the forces for design. This section provides a simple rule that the combined participating mass of all modes considered in the analysis should be equal to or greater than 90 percent of the effective total mass in each of two orthogonal horizontal directions.

**5.4.4 Periods:** Natural periods of vibration are required for each of the modes used in the subsequent calculations. These are needed to determine the modal coefficients  $C_{sm}$  from Eq. 5.4.5-3. Because the periods of the modes contemplated in these requirements are those associated with moderately large, but still essentially linear, structural response, the period calculations should include only those elements that are effective at these amplitudes. Such periods may be longer than those obtained from a small-amplitude test of the structure when completed or the response to small earthquake motions because of the stiffening effects of nonstructural and architectural components of the structure at small amplitudes. During response to strong ground-shaking, however, measured responses of structures have shown that the periods lengthen, indicating the loss of the stiffness contributed by those components.

There exists a wide variety of methods for calculation of natural periods and associated mode shapes, and no one particular method is required by the *Provisions*. It is essential, however, that the method used be one based on generally accepted principles of mechanics such as those given in well known textbooks on structural dynamics and vibrations (Clough and Penzien, 1975; Newmark and Rosenblueth, 1971; Thomson, 1965; Wiegel, 1970). Although it is expected that in many cases computer programs, whose accuracy and reliability are documented and widely recognized, will be used to calculate the required natural periods and associated mode shapes, their use is not required.

**5.4.5 Modal Base Shear:** A central feature of modal analysis is that the earthquake response is considered as a combination of the independent responses of the structure vibrating in each of its important modes. As the structure vibrates back and forth in a particular mode at the associated period, it experiences maximum values of base shear, interstory drifts, floor displacements, base (overturning) moments, etc. In this section, the base shear in the  $m^{\text{th}}$  mode is specified as the product

of the modal seismic coefficient  $C_{sm}$  and the effective weight  $W_m$  for the mode. The coefficient  $C_{sm}$  is determined for each mode from Eq. 5.4.5-3 using the associated period of the mode,  $T_m$ , in addition to the factors  $C_v$  and  $R$ , which are discussed elsewhere in the *Commentary*. An exception to this procedure occurs for higher modes of those *structures* that have periods shorter than 0.3 second and that are founded on soils of *Site Class* D, E, or F. For such modes, Eq. 5.4.5-4 is used. Equation 5.4.5-4 gives values ranging from  $S_{DS}/2.5R$  for very short periods to  $S_{DS}/R$  for  $T_m = 0.3$ . Comparing these values to the limiting values of  $C_s$  of  $S_{DS}/R$  for soils with Soil Profile Type D as specified following Eq. 5.4.5-3, it is seen that the use of Eq. 5.4.5-4, when applicable, reduces the modal base shear. This is an approximation introduced in consideration of the conservatism embodied in using the spectral shape specified by Eq. 5.4.5-3 and its limiting values. The spectral shape so defined is a conservative approximation to average spectra that are known to first ascend, level off, and then decay as period increases. Equation 5.4.5-3 and its limiting values conservatively replace the ascending portion for small periods by a level portion. For soils with Soil Profile Type A, B and C, the ascending portion of the spectra is completed by the time the period reaches a small value near 0.1 or 0.2 second. On the other hand, for soft soils the ascent may not be completed until a larger period is reached. Equation 5.4.5-4 is then a replacement for the spectral shape for soils with Soil Profile Type D, E and F and short periods that is more consistent with spectra for measured accelerations. It was introduced because it was judged unnecessarily conservative to use Eq. 5.4.5-3 for modal analysis in the case of soils with Soil Profile Types D, E, and F. The effective modal gravity load given in Eq. 5.4.5-2 can be interpreted as specifying the portion of the weight of the structure that participates in the vibration of each mode. It is noted that Eq. 5.4.5-2 gives values of  $W_m$  that are independent of how the modes are normalized.

The final equation of this section, Eq. 5.4.5-5, is to be used if a modal period exceeds 4 seconds. It can be seen that Eq. 5.4.5-5 and 5.4.5-3 coincide at  $T_m = 4$  seconds so that the effect of using Eq. 5.4.5-5 is to provide a more rapid decrease in  $C_{sm}$  as a function of the known characteristics of earthquake response spectra at intermediate and long periods. At intermediate periods, the average velocity spectrum of strong earthquake motions from large (magnitude 6.5 and larger) earthquakes is approximately constant, which implies that  $C_{sm}$  should decrease as  $1/T_m$ . For very long periods, the average displacement spectrum of strong earthquake motions becomes constant which implies that  $C_{sm}$ , a form of acceleration spectrum, should decay as  $1/T_m^2$ . The period at which the displacement response spectrum becomes constant depends on the size of the earthquake, being larger for great earthquakes, and a representative period of 4 seconds was chosen to make the transition.

**5.4.6 Modal Forces, Deflections, and Drifts:** This section specifies the forces and displacements associated with each of the important modes of response.

Modal forces at each level are given by Eq. 5.4.6-1 and 5.4.6-2 and are expressed in terms of the gravity load assigned to the floor, the mode shape, and the modal base shear  $V_m$ . In applying the forces  $F_{xm}$  to the structure, the direction of the forces is controlled by the algebraic sign of  $f_{xm}$ . Hence, the modal forces for the fundamental mode will all act in the same direction, but modal forces for the second and higher modes will change direction as one moves up the structure. The form of Eq. 5.4.6-1 is somewhat different from that usually employed in standard references and shows clearly the relation between the modal forces and the modal base shear. It therefore is a convenient form for calculation and highlights the similarity to Eq. 5.3.4-1 in the ELF procedure.

The modal deflections at each level are specified by Eq. 5.4.6-3. These are the displacements caused by the modal forces  $F_{xm}$  considered as static forces and are representative of the maximum amplitudes of modal response for the essentially elastic motions envisioned within the concept of the seismic response modification coefficient  $R$ . This is also a logical point to calculate the modal drifts, which are required in Sec. 5.4.8. If the mode under consideration dominates the earthquake response, the modal deflection under the strongest motion contemplated by the *Provisions* can be estimated by multiplying by the deflection amplification factor  $C_d$ . It should be noted also that  $d_{xm}$  is proportional to  $f_{xm}$  (this can be shown with algebraic substitution for  $F_{xm}$  in Eq. 5.4.6-4) and will therefore change direction up and down the structure for the higher modes.

**5.4.7 Modal Story Shears and Moments:** This section merely specifies that the forces of Eq. 5.4.6-1 should be used to calculate the shears and moments for each mode under consideration. In essence, the forces from Eq. 5.4.6-1 are applied to each mass, and linear static methods are used to calculate story shears and story overturning moments. The base shear that results from the calculation should check with Eq. 5.4.5-1.

**5.4.8 Design Values:** This section specifies the manner in which the values of story shear, moment, and drift quantities and the deflection at each level are to be combined. The method used, in which the design value is the square root of the sum of the squares of the modal quantities, was selected for its simplicity and its wide familiarity (Clough and Penzien, 1975; Newmark and Rosenblueth, 1971; Wiegel, 1970). In general, it gives satisfactory results, but it is not always a conservative predictor of the earthquake response inasmuch as more adverse combinations of modal quantities than are given by this method of combination can occur. The most common instance where combination by use of the square root of the sum of the squares is unconservative occurs when two modes have very nearly the same natural period. In this case, the responses are highly correlated and the designer should consider combining the modal quantities more conservatively (Newmark and Rosenblueth, 1971). In the 1991 Edition of the *Provisions* the option of combining these quantities by the complete quadratic combination (CQC) technique was introduced. This method provides somewhat better results than the square root of the sum of squares method for the case of closely spaced modes.

This section also limits the reduction of base shear that can be achieved by modal analysis compared to use of the ELF procedure. Some reduction, where it occurs, is thought justified because the modal analysis gives a somewhat more accurate representation of the earthquake response. Some limit to any such possible reduction that may occur from the calculation of longer natural periods is necessary because the actual periods of vibration may not be as long, even at moderately large amplitudes of motion, due to the stiffening effects of elements not a part of the seismic resisting system and of nonstructural and architectural components. The limit is imposed by comparison to the ELF procedure with a 20 percent increase in the factor  $C_u$ .

**5.4.9 Horizontal Shear Distribution and Torsion:** This section requires that the design story shears calculated in Sec. 5.4.8 and the torsional moments prescribed in Sec. 5.3.5 be distributed to the vertical elements of the seismic resisting system as specified in Sec. 5.3.5 and as elaborated on in the corresponding section of this commentary.

**5.4.10 Foundation Overturning:** Because story moments are calculated mode by mode (properly recognizing that the direction of forces  $F_{xm}$  is controlled by the algebraic sign of  $f_{xm}$ ) and then combined to obtain the design values of story moments, there is no reason for reducing these design moments. This is in contrast with reductions permitted in overturning moments calculated from equivalent lateral



forces in the analysis procedures of Sec. 5.3 (see Sec. 5.3.6 of this commentary). However, in the design of the foundation, the overturning moment calculated at the foundation-soil interface may be reduced by 10 percent for the reasons mentioned in Sec. 5.3.6 of this commentary.

**5.4.11 P-delta Effects:** Sec. 5.3.7 of this commentary applies to this section. In addition, to obtain the story drifts when using the modal analysis procedure of Sec. 5.4, the story drift for each mode should be independently determined in each story (Sec. 5.4.6). The story drift should not be determined from the differential combined lateral structural deflections since this latter procedure will tend to mask the higher mode effects in longer period structures.

## **5.5 SOIL-STRUCTURE INTERACTION EFFECTS:**

### **5.5.1 General:**

*Statement of the Problem:* Fundamental to the design requirements presented in Sec. 5.3 and 5.4 is the assumption that the motion experienced by the base of a structure during an earthquake is the same as the free-field ground motion, a term that refers to the motion that would occur at the level of the foundation if no structure was present. Strictly speaking, this assumption is true only for structures supported on essentially rigid ground. For structures supported on soft soil, the foundation motion generally is different from the free-field motion and may include an important rocking component in addition to a lateral or translational component. The rocking component may be particularly significant for tall structures.

A flexibly supported structure also differs from a rigidly supported structure in that a substantial part of its vibrational energy may be dissipated into the supporting medium by radiation of waves and by hysteretic action in the soil. The importance of the latter factor increases with increasing intensity of ground-shaking. There is, of course, no counterpart of this effect of energy dissipation in a rigidly supported structure.

The effects of soil-structure interaction accounted for in Sec. 5.5 represent the difference in the response of the structure computed by assuming the motion of the foundation to be the same as the free-field ground motion and considering the modified or actual motion of the foundation. This difference depends on the characteristics of the free-field ground motion as well as on the properties of the structure and the supporting medium.

The interaction effects accounted for in Sec. 5.5 should not be confused with "site effects," which refer to the fact that the characteristics of the free-field ground motion induced by a dynamic event at a given site are functions of the properties and geological features of the subsurface soil and rock. The interaction effects, on the other hand, refer to the fact that the dynamic response of a structure built on that site depends, in addition, on the interrelationship of the structural characteristics and the properties of the local underlying soil deposits. The site effects are reflected in the values of the seismic coefficients employed in Sec. 5.3 and 5.4 and are accounted for only implicitly in Sec. 5.5.

*Possible Approaches to the Problem:* Two different approaches may be used to assess the effects of soil-structure interaction. The first involves modifying the stipulated free-field design ground motion and evaluating the response of the given structure to the modified motion of the foundation whereas the second involves modifying the dynamic properties of the structure and evaluating the response of the modified structure to the prescribed free-field ground motion (Veletsos, 1977). When properly implemented, both approaches lead to equivalent results. However, the second approach, involving

the use of the free-field ground motion, is more convenient for design purposes and provides the basis of the requirements presented in the Sec. 5.5.

*Characteristics of Interaction:* The interaction effects in the approach used here are expressed by an increase in the fundamental natural period of the structure and a change (usually an increase) in its

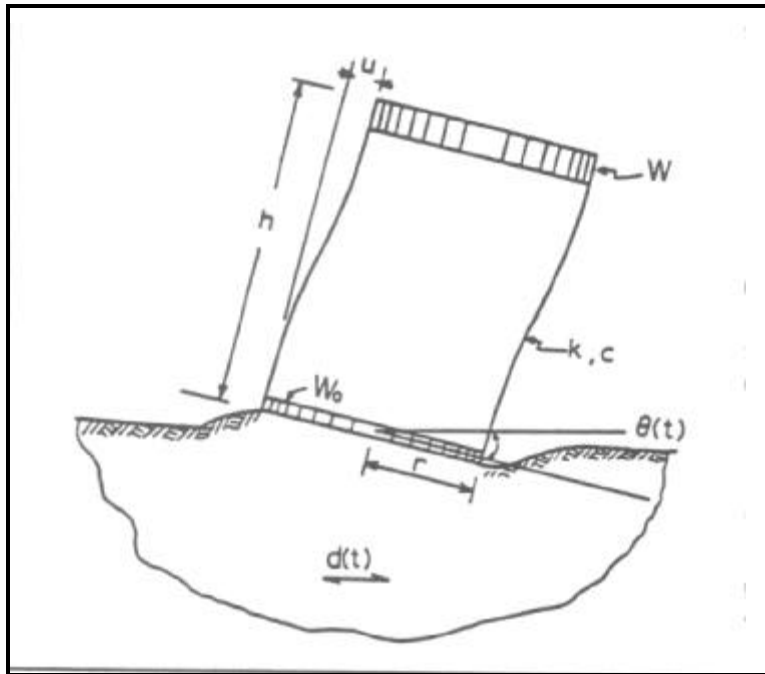

FIGURE C5.5.1-1 Simple system investigated.

effective damping. The increase in period results from the flexibility of the foundation soil whereas the change in damping results mainly from the effects of energy dissipation in the soil due to radiation and material damping. These statements can be clarified by comparing the responses of rigidly and elastically supported systems subjected to a harmonic excitation of the base. Consider a linear structure of weight  $W$ , lateral stiffness  $k$ , and coefficient of viscous damping  $c$  (shown in Figure C5.5.1-1) and assume that it is supported by a foundation of weight  $W_0$  at the surface of a homogeneous, elastic halfspace.

The foundation mat is idealized as a rigid circular plate of negligible

thickness bonded to the supporting medium, and the columns of the structure are considered to be weightless and axially inextensible. Both the foundation weight and the weight of the structure are assumed to be uniformly distributed over circular areas of radius  $r$ . The base excitation is specified by the free-field motion of the ground surface. This is taken as a horizontally directed, simple harmonic motion with a period  $T_0$  and an acceleration amplitude  $a_m$ .

The configuration of this system, which has three degrees of freedom when flexibly supported and a single degree of freedom when fixed at the base, is specified by the lateral displacement and rotation of the foundation,  $y$  and  $\theta$ , and by the displacement relative to the base of the top of the structure,  $u$ . The system may be viewed either as the direct model of a one-story structural frame or, more generally, as a model of a multistory, multimode structure that responds as a single-degree-of-freedom system in its fixed-base condition. In the latter case,  $h$  must be interpreted as the distance from the base to the centroid of the inertia forces associated with the fundamental mode of vibration of the fixed-base structure and  $W$ ,  $k$ , and  $c$  must be interpreted as its generalized or effective weight, stiffness, and damping coefficient, respectively. The relevant expressions for these quantities are given below.

The solid lines in Figures C5.5.1-2 and 5.5.1-3 represent response spectra for the steady-state amplitude of the total shear in the columns of the system considered in Figure C5.5.1-1. Two different values of  $h/r$  and several different values of the relative flexibility parameter for the soil and the struc-

ture,  $\beta$ , are considered. The latter parameter is defined by the equation  $\beta = \frac{h}{v_s T}$  in which  $h$  is the

height of the structure as previously indicated,  $v_s$  is the velocity of shear wave propagation in the halfspace, and  $T$  is the fixed-base natural period of the structure. A value of  $\beta = 0$  corresponds to a rigidly supported structure.

The results in Figures C5.5.1-2 and 5.5.1-3 are displayed in a dimensionless form, with the abscissa representing the ratio of the period of the excitation,  $T_o$ , to the fixed-base natural period of the system,

$T$ , and the ordinate representing the ratio of the amplitude of the actual base shear,  $V$ , to the amplitude of the base shear induced in an infinitely stiff, rigidly supported structure.

The latter quantity is given by the product  $ma_m$ , in which  $m = W/g$ ,  $g$  is the acceleration of gravity, and  $a_m$  is the acceleration amplitude of the free-field ground motion.

The inclined scales on the left represent the deformation amplitude of the superstructure,  $u$ , normalized with respect to the displacement amplitude of the free-field

$$d_m = \frac{a_m T_0^2}{4 \beta^2}$$

ground motion  $d_m$ . The damping of the structure in its fixed-base condition,  $\beta$ , is considered to be 2 percent of the critical value, and the additional parameters needed to characterize completely these solutions are identified in Veletsos and Meek (1974), from which these figures have been reproduced.

Comparison of the results presented in these figures reveals that the effects of soil-structure interaction are most strikingly reflected in a shift of the peak of the response spectrum to the right and a change in the magnitude of the peak.

These changes, which are particularly prominent for taller structures and more flexible soils (increasing values of  $\beta$ ), can conveniently be expressed by an increase in the natural period of the system over its fixed-base value and by a change in its damping factor.

Also shown in these figures in dotted lines are response spectra for single-degree-of-freedom (SDF) oscillators, the natural period and damping of which have been adjusted so that the absolute maximum (resonant) value of the base shear and the associated period are in each case identical to those of the actual interacting systems. The base motion for the replacement oscillator is considered to be the same as the free-field ground motion. With the properties of the replacement SDF oscillator determined in

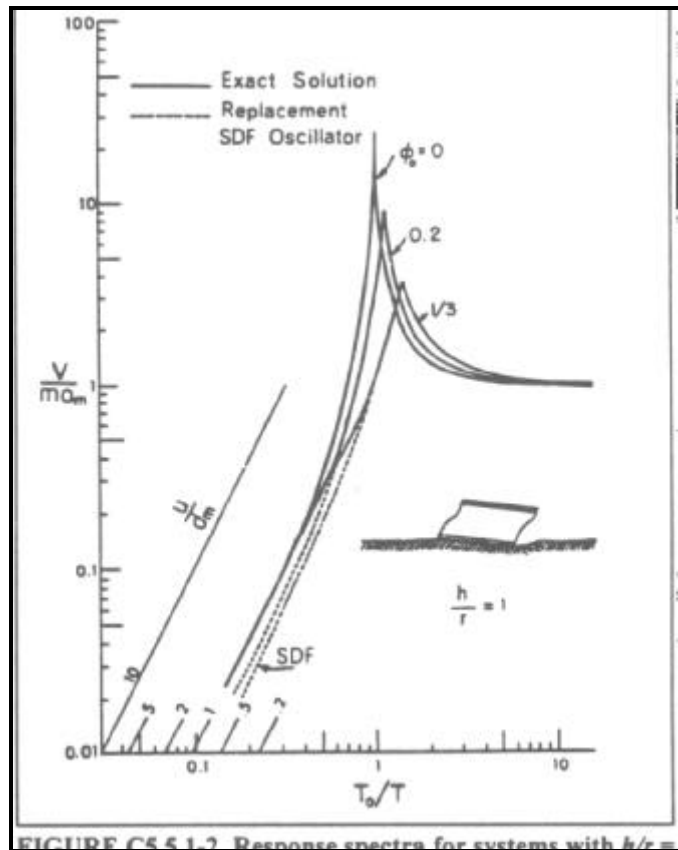

FIGURE C5.5.1-2 Response spectra for systems with  $h/r = 1$  (Veletsos and Meek, 1974).

this manner, it is important to note that the response spectra for the actual and the replacement systems are in excellent agreement over wide ranges of the exciting period on both sides of the resonant peak.

In the context of Fourier analysis, an earthquake motion may be viewed as the result of superposition of harmonic motions of different periods and amplitudes. Inasmuch as the components of the excitation with periods close to the resonant period are likely to be the dominant contributors to the

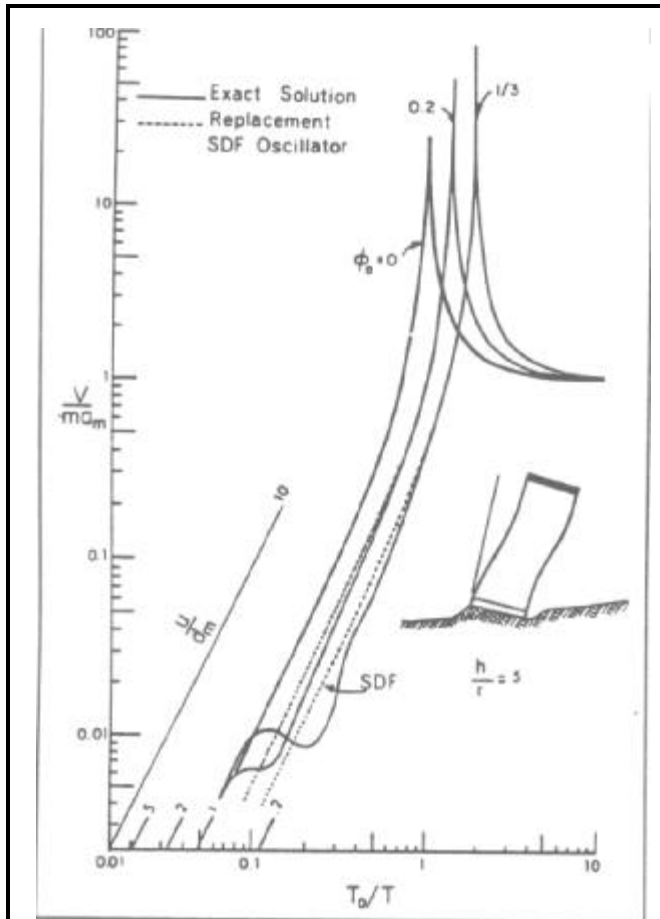

FIGURE C5.5.1-3 Response spectra for systems with  $h/r = 5$  (Veletsos and Meek, 1974).

response, the maximum responses of the actual system and of the replacement oscillator can be expected to be in satisfactory agreement for earthquake ground motions as well. This expectation has been confirmed by the results of comprehensive comparative studies (Veletsos, 1977; Veletsos and Meek, 1974; Veletsos and Nair, 1975).

It follows that, to the degree of approximation involved in the representation of the actual system by the replacement SDF oscillator, the effects of interaction on maximum response may be expressed by an increase in the fundamental natural period of the fixed-base system and by a change in its damping value. In the following sections, the natural period of replacement oscillator is denoted by  $T$  and the associated damping factor, by  $\tilde{\gamma}$ . These quantities will also be referred to as the effective natural period and the effective damping factor of the interacting system. The relationships between  $T$  and  $T$  and between  $\tilde{\gamma}$  and  $\gamma$  are considered in Sec. 5.5.2.1.1 and 5.5.2.1.2.

#### *Basis of Provisions and Assumptions:*

Current knowledge of the effects of soil-structure interactions is derived mainly from studies of systems of the type referred

to above in which the foundation is idealized as a rigid mat. For foundations of this type, both surface-supported and embedded structures resting on uniform as well as layered soil deposits have been investigated (Bielak, 1975; Chopra and Gutierrez, 1974; Jennings and Bielak, 1973; Liu and Fagel, 1971; Parmelee et al., 1969; Roesset et al., 1973; Veletsos, 1977; Veletsos and Meek, 1974; Veletsos and Nair, 1975). However, only a small amount of information is available concerning the interaction effects for structures supported on spread footings or pile foundations (Blaney et al., n.d.; Novak, 1974; Rainer, 1975b). The requirements presented in Sec. 5.5 for the latter cases represent the best interpretation and judgment of the developers of the requirements regarding the current state of knowledge.

Fundamental to these requirements is the assumption that the structure and the underlying soil are bonded and remain so throughout the period of ground-shaking. It is further assumed that there is no soil instability or large foundation settlements. The design of the foundation in a manner to ensure satisfactory soil performance (e.g., to avoid soil instability and settlement associated with the compaction and liquefaction of loose granular soils), is beyond the scope of Sec. 5.5. Finally, no account is taken of the interaction effects among neighboring structures.

*Nature of Interaction Effects:* Depending on the characteristics of the structure and the ground motion under consideration, soil-structure interaction may increase, decrease, or have no effect on the magnitudes of the maximum forces induced in the structure itself (Bielak, 1975; Jennings and Bielak, 1973; Veletsos, 1977; Veletsos and Meek, 1974; Veletsos and Nair, 1975). However, for the conditions stipulated in the development of the requirements for rigidly supported structures presented in Sec. 5.3 and 5.4, soil-structure interaction will reduce the design values of the base shear and moment from the levels applicable to a rigid-base condition. These forces therefore can be evaluated conservatively without the adjustments recommended in Sec. 5.5.

Because of the influence of foundation rocking, however, the horizontal displacements relative to the base of the elastically supported structure may be larger than those of the corresponding fixed-base structure, and this may increase both the required spacing between structures and the secondary design forces associated with the  $P$ -delta effects. Such increases generally are small.

*Scope:* Two procedures are used to incorporate effects of the soil-structure interaction. The first is an extension of the equivalent lateral force procedure presented in Sec. 5.3 and involves the use of equivalent lateral static forces. The second is an extension of the simplified modal analysis procedure presented in Sec. 5.4. In the latter approach, the earthquake-induced effects are expressed as a linear combination of terms, the number of which is equal to the number of stories involved. Other more complex procedures also may be used, and these are outlined briefly at the end of this commentary on Sec. 5.5. However, it is believed that the more involved procedures are justified only for unusual structures of extreme importance and only when the results of the specified simpler approaches have revealed that the interaction effects are indeed of definite consequence in the design.

**5.5.2 Equivalent Lateral Force Procedure:** This procedure is similar to that used in the older SEAOC recommendations except that it incorporates several improvements (see Sec. 5.3 of this commentary). In effect, the procedure considers the response of the structure in its fundamental mode of vibration and accounts for the contributions of the higher modes implicitly through the choice of the effective weight of the structure and the vertical distribution of the lateral forces. The effects of soil-structure interaction are accounted for on the assumption that they influence only the contribution of the fundamental mode of vibration. For structures, this assumption has been found to be adequate (Bielak, 1976; Jennings and Bielak, 1973; Veletsos, 1977).

**5.5.2.1 Base Shear:** With the effects of soil-structure interaction neglected, the base shear is defined by Eq. 5.3.2,  $V = C_s W$ , in which  $W$  is the total dead weight of the structure and of applicable portions of the design live load (as specified in Sec. 5.3.2) and  $C_s$  is the dimensionless seismic response coefficient (as defined by Eq. 5.3.2.1-1). This term depends on the seismic zone under consideration, the properties of the site, and the characteristics of the structure itself. The latter characteristics include the fixed-base fundamental natural period of the structure,  $T$ ; the associated damping factor,  $\zeta$ ; and the degree of permissible inelastic deformation. The damping factor does not appear explicitly in Eq. 5.3.2.1-1 because a constant value of  $\zeta = 0.05$  has been used for all structures for which the

interaction effects are negligible. The degree of permissible inelastic action is reflected in the choice of the reduction factor,  $R$ . It is convenient to rewrite Eq. 5.3.2.1 in the form:

$$V = C_s(T, \zeta) \bar{W} + C_s(T, \zeta) [W - \bar{W}] \quad (\text{C5.5.2.1-1})$$

where  $\bar{W}$  represents the generalized or effective weight of the structure when vibrating in its fundamental natural mode. The terms in parentheses are used to emphasize the fact that  $C_s$  depends upon both  $T$  and  $\zeta$ . The relationship between  $\bar{W}$  and  $W$  is given below. The first term on the right side of Eq. C5.5.2.1-1 approximates the contribution of the fundamental mode of vibration whereas the second term approximates the contributions of the higher natural modes. Inasmuch as soil-structure interaction may be considered to affect only the contribution of the fundamental mode and inasmuch as this effect can be expressed by changes in the fundamental natural period and the associated damping of the system, the base shear for the interacting system,  $V$ , may be stated in a form analogous to Eq. C5.5.2.1-1:

$$V = C_s(T, \zeta) \bar{W} + C_s(T, \zeta) [W - \bar{W}] \quad (\text{C5.5.2.1-2})$$

The value of  $C_s$  in the first part of this equation should be evaluated for the natural period and damping of the elastically supported system,  $T$  and  $\zeta$ , respectively, and the value of  $C_s$  in the second term part should be evaluated for the corresponding quantities of the rigidly supported system,  $\tilde{T}$  and  $\tilde{\zeta}$ .

Before proceeding with the evaluation of the coefficients  $C_s$  in Eq. C5.5.2.1-2, it is desirable to rewrite this formula in the same form as Eq. 5.5.2.1-1. Making use of Eq. 5.3.2.1 and rearranging terms, the following expression for the reduction in the base shear is obtained:

$$V = [C_s(T, \zeta) - C_s(\tilde{T}, \tilde{\zeta})] \bar{W} \quad (\text{C5.5.2.1-3})$$

Within the ranges of natural period and damping that are of interest in studies of structural response, the values of  $C_s$  corresponding to two different damping values but the same natural period (e.g.,  $T$ ), are related approximately as follows:

$$C_s(\tilde{T}, \tilde{\zeta}) = C_s(\tilde{T}, \zeta) \left( \frac{\zeta}{\tilde{\zeta}} \right)^{0.4} \quad (\text{C5.5.2.1-4})$$

This expression, which appears to have been first proposed in Arias and Husid (1962), is in good agreement with the results of recent studies of earthquake response spectra for systems having different damping values (Newmark et al., 1973).

Substitution of Eq. C5.5.2.1-4 in Eq. C5.5.2.1-3 leads to:

$$V = \left[ C_s(T, \zeta) - C_s(\tilde{T}, \zeta) \left( \frac{\zeta}{\tilde{\zeta}} \right)^{0.4} \right] \bar{W} \quad (\text{C5.5.2.1-5})$$

where both values of  $C_s$  are now for the damping factor of the rigidly supported system and may be evaluated from Eq. 5.3.2. If the terms corresponding to the periods  $T$  and  $T$  are denoted more simply as  $C_s$  and  $C_s$ , respectively, and if the damping factor is taken as 0.05, Eq. C5.5.2.1-5 reduces to Eq. 5.5.2.1-2.

Note that  $C_s$  in Eq. 5.5.2.1-2 is smaller than or equal to  $C_s$  because Eq. 5.3.2 is a nonincreasing function of the natural period and  $T$  is greater than or equal to  $T$ . Furthermore, since the minimum value of  $\tilde{\gamma}$  is taken as  $\tilde{\gamma} = 0.05$  (see statement following Eq. 5.5.2.1.2-1), the shear reduction  $V$  is a non-negative quantity. It follows that the design value of the base shear for the elastically supported structure cannot be greater than that for the associated rigid-base structure.

The effective weight of the structure,  $W$ , is defined by Eq. 5.4.5-2 (Sec. 5.4), in which  $u_{im}$  should be interpreted as the displacement amplitude of the  $i^{\text{th}}$  floor when the structure is vibrating in its fixed-base fundamental natural mode. It should be clear that the ratio  $W/W$  depends on the detailed characteristics of the structure. A constant value of  $W = 0.7 W$  is recommended in the interest of simplicity and because it is a good approximation for typical structures. As an example, it is noted that for a tall structure for which the weight is uniformly distributed along the height and for which the fundamental natural mode increases linearly from the base to the top, the exact value of  $W = 0.75 W$ . Naturally, when the full weight of the structure is concentrated at a single level,  $W$  should be taken equal to  $W$ .

The maximum permissible reduction in base shear due to the effects of soil-structure interaction is set at 30 percent of the value calculated for a rigid-base condition. It is expected, however, that this limit will control only infrequently and that the calculated reduction, in most cases, will be less.

**5.5.2.1.1 Effective Building Period:** Equation 5.5.2.1.1-1 for the effective natural period of the elastically supported structure,  $T$ , is determined from analyses in which the superstructure is presumed to respond in its fixed-base fundamental mode and the foundation weight is considered to be negligible in comparison to the weight of the superstructure (Jennings and Bielak, 1973; Veletsos and Meek, 1974). The first term under the radical represents the period of the fixed-base structure. The first portion of the second term represents the contribution to  $T$  of the translational flexibility of the foundation, and the last portion represents the contribution of the corresponding rocking flexibility. The quantities  $k$  and  $h$  represent, respectively, the effective stiffness and effective height of the structure, and  $K_y$  and  $K$  represent the translational and rocking stiffnesses of the foundation.

Equation 5.5.2.1.1-2 for the structural stiffness,  $k$ , is deduced from the well known expression for the natural period of the fixed-base system:

$$T = 2 \sqrt{\left(\frac{1}{g}\right) \left(\frac{W}{k}\right)} \quad (\text{C5.5.2.1.1-1})$$

The effective height,  $h$ , is defined by Eq. 5.5.3.1-2, in which  $u_{im}$  has the same meaning as the quantity  $u_{im}$  in Eq. 5.4.5-2 (Sec. 5.4) when  $m = 1$ . In the interest of simplicity and consistency with the approximation used in the definition of  $W$ , however, a constant value of  $h = 0.7h_n$  is recommended where  $h_n$  is the total height of the structure. This value represents a good approximation for typical structures. As an example, it is noted that for tall structures for which the fundamental natural mode

increases linearly with height, the exact value of  $\bar{h}$  is  $2/3h_n$ . Naturally, when the gravity load of the structure is effectively concentrated at a single level,  $h_n$  must be taken as equal to the distance from the base to the level of weight concentration.

Foundation stiffnesses depend on the geometry of the foundation-soil contact area, the properties of the soil beneath the foundation, and the characteristics of the foundation motion. Most of the available information on this subject is derived from analytical studies of the response of harmonically excited rigid circular foundations, and it is desirable to begin with a brief review of these results.

For circular mat foundations supported at the surface of a homogeneous halfspace, stiffnesses  $K_y$  and  $K$  are given by:

$$K_y = \frac{8 a_y}{(2 - \nu) Gr} \quad (\text{C5.5.2.1.1-2})$$

and

$$K = \left[ \frac{8}{3(1 - \nu)} \right] Gr^3 \quad (\text{C5.5.2.1.1-3})$$

where  $r$  is the radius of the foundation;  $G$  is the shear modulus of the halfspace;  $\nu$  is its Poisson's ratio; and  $a_y$  and  $a$  are dimensionless coefficients that depend on the period of the excitation, the dimensions of the foundation, and the properties of the supporting medium (Luco, 1974; Veletsos and Verbic, 1974; Veletsos and Wei, 1971). The shear modulus is related to the shear wave velocity,  $v_s$ , by the formula:

$$G = \frac{\gamma v_s^2}{g} \quad (\text{C5.5.2.1.1-4})$$

in which  $\gamma$  is the unit weight of the material. The values of  $G$ ,  $v_s$ , and  $\gamma$  should be interpreted as average values for the region of the soil that is affected by the forces acting on the foundation and should correspond to the conditions developed during the design earthquake. The evaluation of these quantities is considered further in subsequent sections. For statically loaded foundations, the stiffness coefficients  $a_y$  and  $a$  are unity, and Eq. C5.5.2.1.1-2 and 5.5.2.1.1-3 reduce to:

$$K_y = \frac{8Gr}{2 - \nu} \quad (\text{C5.5.2.1.1-5})$$

and

$$K = \frac{8Gr^3}{3(1 - \nu)} \quad (\text{C5.5.2.1.1-6})$$



Studies of the interaction effects in structure-soil systems have shown that, within the ranges of parameters of interest for structures subjected to earthquakes, the results are insensitive to the period-dependency of  $\gamma$  and  $\beta$  and that it is sufficiently accurate for practical purposes to use the static stiffnesses, defined by Eq. C5.5.2.1.1-5 and C5.5.2.1.1-6.

Foundation embedment has the effect of increasing the stiffnesses  $K_y$  and  $K$ . For embedded foundations for which there is positive contact between the side walls and the surrounding soil,  $K_y$  and  $K$  may be determined from the following approximate formulas:

$$K_y = \left[ \frac{8Gr}{2 - \gamma} \right] \left[ 1 + \left( \frac{2}{3} \right) \left( \frac{d}{r} \right) \right] \quad (\text{C5.5.2.1.1-7})$$

and

$$K = \left[ \frac{8Gr^3}{3 - \beta} \right] \left[ 1 + 2 \left( \frac{d}{r} \right) \right] \quad (\text{C5.5.2.1.1-8})$$

in which  $d$  is the depth of embedment. These formulas are based on finite element solutions (Blaney et al., n.d.).

Both analyses and available test data (Erden, 1974) indicate that the effects of foundation embedment are sensitive to the condition of the backfill and that judgment must be exercised in using Eq. C5.5.2.1.1-7 and C5.5.2.1.1-8. For example, if a structure is embedded in such a way that there is no positive contact between the soil and the walls of the structure, or when any existing contact cannot reasonably be expected to remain effective during the stipulated design ground motion, stiffnesses  $K_y$  and  $K$  should be determined from the formulas for surface-supported foundations. More generally, the quantity  $d$  in Eq. C5.5.2.1.1-7 and C5.5.2.1.1-8 should be interpreted as the effective depth of foundation embedment for the conditions that would prevail during the design earthquake.

The formulas for  $K_y$  and  $K$  presented above are strictly valid only for foundations supported on reasonably uniform soil deposits. When the foundation rests on a stratum of soft soil underlain by a much stiffer, rock-like deposit with an abrupt increase in stiffness,  $K_y$  and  $K$  may be determined from the two generalized formulas in which  $G$  is the shear modulus of the soft soil and  $D_s$  is the total depth of the stratum. First, using Eq. C5.5.2.1.1-7:

$$K_y = \left[ \frac{8Gr}{2 - \gamma} \right] \left[ 1 + \left( \frac{2}{3} \right) \left( \frac{d}{r} \right) \right] \left[ 1 + \left( \frac{1}{2} \right) \left( \frac{r}{D_s} \right) \right] \left[ 1 + \left( \frac{5}{4} \right) \left( \frac{d}{D_s} \right) \right] \quad (\text{C5.5.2.1.1-9})$$

Second, using Eq. C5.5.2.1.1-8:

$$K = \left[ \frac{8Gr^3}{3(1 - \beta)} \right] \left[ 1 + 2 \left( \frac{d}{r} \right) \right] \left[ 1 + \left( \frac{1}{6} \right) \left( \frac{r}{D_s} \right) \right] \left[ 1 + 0.7 \left( \frac{d}{D_s} \right) \right] \quad (\text{C5.5.2.1.1-10})$$

These formulas are based on analyses of a stratum supported on a rigid base (Elsabee et al., 1977; Kausel and Roesset, 1975).

The information for circular foundations presented above may be applied to mat foundations of arbitrary shapes provided the following changes are made:

1. The radius  $r$  in the expressions for  $K_y$  in Eq. 5.5.2.1.1-5 is replaced by the quantity:

$$r_a = \sqrt{\frac{A_o}{\pi}} \quad (\text{C5.5.2.1.1-11})$$

which represents the radius of a disk that has the area,  $A_o$ , of the actual foundation.

2. The radius  $r$  in the expressions for  $K$  in Eq. 5.5.2.1.1-6 is replaced by the quantity:

$$r_m = \sqrt[4]{\frac{I_o}{\pi}} \quad (\text{C5.5.2.1.1-12})$$

which represents the radius of a disk that has the moment of inertia,  $I_o$ , of the actual foundation.

For footing foundations, stiffnesses  $K_y$  and  $K$  are computed by summing the contributions of the individual footings. If it is assumed that the foundation behaves as a rigid body and that the individual footings are widely spaced so that they act as independent units, the following formulas are obtained:

$$K_y = \sum k_{yi} \quad (\text{C5.5.2.1.1-13})$$

and

$$K = \sum k_{xi} y_i^2 + \sum k_i \quad (\text{C5.5.2.1.1-14})$$

The quantity  $k_{yi}$  represents the horizontal stiffness of the  $i^{\text{th}}$  footing;  $k_{xi}$  and  $k_i$  represent, respectively, the corresponding vertical and rocking stiffnesses; and  $y_i$  represents the normal distance from the centroid of the  $i^{\text{th}}$  footing to the rocking axis of the foundation. The summations are considered to extend over all footings. The contribution to  $K$  of the rocking stiffnesses of the individual footings,  $k_i$ , generally is small and may be neglected.

The stiffnesses  $k_{yi}$ ,  $k_{xi}$ , and  $k_i$  are defined by the formulas:

$$k_{yi} = \left( \frac{8G_i r_{ai}}{2 -} \right) \left( \frac{1 + 2/3d_i}{r_{ai}} \right) \quad (\text{C5.5.2.1.1-15})$$

$$k_{xi} = \left( \frac{4G_i r_{ai}}{1 -} \right) \left( \frac{1 + 0.4d_i}{r_a} \right) \quad (\text{C5.5.2.1.1-16})$$

and

$$k_i = \left[ \frac{8G_i r_{mi}^3}{2(1 - \nu_i)} \right] \left[ \frac{1 + 2d_i}{r_{mi}} \right] \quad (\text{C5.5.2.1.1-17})$$

in which  $d_i$  is the depth of effective embedment for the  $i^{\text{th}}$  footing;  $G_i$  is the shear modulus of the soil beneath the  $i^{\text{th}}$  footing;  $r_{ai} = \sqrt{A_{oi}} / \pi$  is the radius of a circular footing that has the area of the  $i^{\text{th}}$  footing,  $A_{oi}$ ; and  $r_{mi}$  equals  $\sqrt[4]{A_{oi} / \pi} =$  the radius of a circular footing, the moment of inertia of which about a horizontal centroidal axis is equal to that of the  $i^{\text{th}}$  footing,  $I_{oi}$ , in the direction in which the response is being evaluated.

For surface-supported footings and for embedded footings for which the side wall contact with the soil cannot be considered to be effective during the stipulated design ground motion,  $d_i$  in these formulas should be taken as zero. Furthermore, the values of  $G_i$  should be consistent with the stress levels expected under the footings and should be evaluated with due regard for the effects of the dead loads involved. This matter is considered further in subsequent sections. For closely spaced footings, consideration of the coupling effects among footings will reduce the computed value of the overall foundation stiffness. This reduction will, in turn, increase the fundamental natural period of the system,  $T$ , and decrease the value of  $V$ , the amount by which the base shear is reduced due to soil-structure interaction. It follows that the use of Eq. C5.5.2.1.1-13 and 5.5.2.1.1-14 will err on the conservative side in this case. The degree of conservatism involved, however, will partly be compensated by the presence of a basement slab that, even when it is not tied to the structural frame, will increase the overall stiffness of the foundation.

The values of  $K_y$  and  $K_z$  for pile foundations can be computed in a manner analogous to that described in the preceding section by evaluating the horizontal, vertical, and rocking stiffnesses of the individual piles,  $k_{yi}$ ,  $k_{zi}$  and  $k_{pi}$ , and by combining these stiffnesses in accordance with Eq. C5.5.2.1.1-13 and 5.5.2.1.1-14.

The individual pile stiffnesses may be determined from field tests or analytically by treating each pile as a beam on an elastic subgrade. Numerous formulas are available in the literature (Nair et al., 1969) that express these stiffnesses in terms of the modulus of the subgrade reaction and the properties of the pile itself. Although they differ in appearance, these formulas lead to practically similar results. These stiffnesses typically are expressed in terms of the stiffness of an equivalent freestanding cantilever, the physical properties and cross-sectional dimensions of which are the same as those of the actual pile but the length of which is adjusted appropriately. The effective lengths of the equivalent cantilevers for horizontal motion and for rocking or bending motion are slightly different but are often assumed to be equal. On the other hand, the effective length in vertical motion is generally considerably greater. For further details, the reader is referred to Nair et al. (1969).

The soil properties of interest are the shear modulus,  $G$ , or the associated shear wave velocity,  $v_s$ ; the unit weight,  $\gamma$ ; and Poisson's ratio,  $\nu$ . These quantities are likely to vary from point to point of a construction site, and it is necessary to use average values for the soil region that is affected by the forces acting on the foundation. The depth of significant influence is a function of the dimensions of the foundation base and of the direction of the motion involved. The effective depth may be considered to

extend to about  $4r_a$  below the foundation base for horizontal and vertical motions and to about  $1.5r_m$  for rocking motion. For mat foundations, the effective depth is related to the total plan dimensions of the mat whereas for structures supported on widely spaced spread footings, it is related to the dimensions of the individual footings. For closely spaced footings, the effective depth may be determined by superposition of the "pressure bulbs" induced by the forces acting on the individual footings.

Since the stress-strain relations for soils are nonlinear, the values of  $G$  and  $v_s$  also are functions of the strain levels involved. In the formulas presented above,  $G$  should be interpreted as the secant shear modulus corresponding to the significant strain level in the affected region of the foundation soil. The approximate relationship of this modulus to the modulus  $G_o$  corresponding to small amplitude strains (of the order of  $10^{-3}$  percent or less) is given in Table 5.5.2.1.1. The backgrounds of this relationship and of the corresponding relationship for  $v_s/v_{so}$  are identified below.

The low amplitude value of the shear modulus,  $G_o$ , can most conveniently be determined from the associated value of the shear wave velocity,  $v_{so}$ , by use of Eq. C5.5.2.1.1-4. The latter value may be determined approximately from empirical relations or more accurately by means of field tests or laboratory tests.

The quantities  $G_o$  and  $v_{so}$  depend on a large number of factors (Hardin and Black, 1968; Hardin and Drnevich, 1975; Richart et al., n.d.), the most important of which are the void ratio,  $e$ , and the average confining pressure,  $\bar{\sigma}_o$ . The value of the latter pressure at a given depth beneath a particular foundation may be expressed as the sum of two terms as follows:

$$\bar{\sigma}_o = \bar{\sigma}_{os} + \bar{\sigma}_{ob} \quad (\text{C5.5.2.1.1-18})$$

in which  $\bar{\sigma}_{os}$  represents the contribution of the weight of the soil and  $\bar{\sigma}_{ob}$  represents the contribution of the superimposed weight of the structure and foundation. The first term is defined by the formula:

$$\bar{\sigma}_{os} = \left( \frac{1 + 2K_o}{3} \right) \gamma' x \quad (\text{C5.5.2.1.1-19})$$

in which  $x$  is the depth of the soil below the ground surface,  $\gamma'$  is the average effective unit weight of the soil to the depth under consideration, and  $K_o$  is the coefficient of horizontal earth pressure at rest. For sands and gravel,  $K_o$  has a value of 0.5 to 0.6 whereas for soft clays,  $K_o = 1.0$ . The pressures  $\bar{\sigma}_{ob}$  developed by the weight of the structure can be estimated from the theory of elasticity (Poulos and Davis, 1974). In contrast to  $\bar{\sigma}_{os}$  which increases linearly with depth, the pressures  $\bar{\sigma}_{ob}$  decrease with depth. As already noted, the value of  $v_{so}$  should correspond to the average value of  $\bar{\sigma}_o$  in the region of the soil that is affected by the forces acting on the foundation.

For clean sands and gravels having  $e < 0.80$ , the low-amplitude shear wave velocity can be calculated approximately from the formula:

$$v_{so} = c_1 (2.17 - e) (\bar{\sigma}_o)^{0.25} \quad (\text{C5.5.2.1.1-20})$$

in which  $c_1$  equals 78.2 when  $\bar{\sigma}_o$  is in lb/ft<sup>2</sup> and  $v_{so}$  is in ft/sec;  $c_1$  equals 160.4 when  $\bar{\sigma}_o$  is in kg/cm<sup>2</sup> and  $v_{so}$  is in m/sec; and  $c_1$  equals 51.0 when  $\bar{\sigma}_o$  is in kN/m<sup>2</sup> and  $v_{so}$  is in m/sec.

For angular-grained cohesionless soils ( $e > 0.6$ ), the following empirical equation may be used:

$$v_{so} = c_2(2.97 - e)(\bar{\sigma})^{0.25} \quad (\text{C5.5.2.1.1-21})$$

in which  $c_2$  equals 53.2 when  $\bar{\sigma}$  is in lb/ft<sup>2</sup> and  $v_{so}$  is in ft/sec;  $c_2$  equals 109.7 when  $\bar{\sigma}$  is in kg/cm<sup>2</sup> and  $v_{so}$  is in m/sec; and  $c_2$  equals 34.9 when  $\bar{\sigma}$  is in kN/m<sup>2</sup> and  $v_{so}$  is in m/sec.

Equation C5.5.2.1.1-21 also may be used to obtain a first-order estimate of  $v_{so}$  for normally consolidated cohesive soils. A crude estimate of the shear modulus,  $G_o$ , for such soils may also be obtained from the relationship:

$$G_o = 1,000S_u \quad (\text{C5.5.2.1.1-22})$$

in which  $S_u$  is the shearing strength of the soil as developed in an unconfined compression test. The coefficient 1,000 represents a typical value, which varied from 250 to about 2,500 for tests on different soils (Hara et al., 1974; Hardin and Drnevich, 1975).

These empirical relations may be used to obtain preliminary, order-of-magnitude estimates. For more accurate evaluations, field and/or laboratory determinations may be required. Field evaluations of the variations of  $v_{so}$  throughout the construction site can be carried out by standard seismic refraction methods or by the cross-hole method. The cross-hole method (Ballard and McLean, 1975; Stokoe and Woods, 1972) provides information from undisturbed soils below the proposed location of a particular foundation. The method permits evaluation of  $v_{so}$  in layered soils and is not affected by the presence of water in the soil. The low-amplitude procedure is relatively inexpensive and easy to use. The disadvantage of this method is that  $v_{so}$  is determined only for the stress conditions existing at the time of the test (usually  $\bar{\sigma}_{so}$ ). The effect of the changes in the stress conditions caused by construction must be considered by use of Eq. C5.5.2.1.1-19 and Eq. C5.5.2.1.1-20 to C5.5.2.1.1-21 to adjust the field measurement of  $v_{so}$  to correspond to the prototype situations. The influence of large-amplitude shearing strains may be evaluated from laboratory tests or approximated through the use of Table 5.5.2.1.1. This matter is considered further in the next two sections.

Laboratory tests to evaluate  $v_{so}$  are usually carried out with resonant column devices (Richart et al., n.d.). Such tests may be used to assess the effects of changes in confining pressures, shearing strain amplitudes, stress histories, temperature, and other variables. Consequently, they can easily simulate variations in prototype loading conditions. They are particularly useful in establishing the effects of changes in confining pressures. In fact, Eq. C5.5.5.1.1-20 and C5.5.5.1.1-21 were developed from the results of such tests.

An increase in the shearing strain amplitude is associated with a reduction in the secant shear modulus,  $G$ , and the corresponding value of  $v_s$ . Extensive laboratory tests (see, for example, Anderson and Richart, 1976; Hardin and Drnevich, 1972; Kuribayashi et al., 1974) have established the magnitudes of the reductions in  $v_s$  for both sands and clays as the shearing strain amplitude increases.

The results of such tests form the basis for the information presented in Table 5.5.5.1.1. For each severity of anticipated ground-shaking, represented by the effective peak acceleration coefficients  $A_a$  and  $A_v$ , a representative value of shearing strain amplitude was developed. A conservative value of  $v_s/v_{so}$  that is appropriate to that strain amplitude then was established. It should be emphasized that the

values in Table 5.5.5.1.1 are first order approximations. More precise evaluations would require laboratory tests on undisturbed samples from the site and studies of wave propagation for the site to determine the magnitude of the soil strains induced.

It is satisfactory to assume Poisson's ratio for soils as:  $\nu = 0.33$  for clean sands and gravels,  $\nu = 0.40$  for stiff clays and cohesive soils, and  $\nu = 0.45$  for soft clays. The use of an average value of  $\nu = 0.4$  also will be adequate for practical purposes.

Regarding an alternative approach, note that Eq. 5.5.5.1.1-3 for the period  $T$  of structures supported on mat foundations was deduced from Eq. 5.5.5.1.1-1 by making use of Eq. C5.5.5.1.1-5 and C5.5.5.1.1-6, with Poisson's ratio taken as  $\nu = 0.4$  and with the radius  $r$  interpreted as  $r_a$  in Eq. C5.5.5.1.1-5 and as  $r_m$  in Eq. C5.5.5.1.1-6. For a nearly square foundation, for which  $r_a \approx r_m \approx r$ , Eq. 5.5.5.1.1-3 reduces to:

$$\tilde{T} = T \sqrt{\left[ 1 + 25 \left( \frac{r\bar{h}}{v_s^2 T^2} \right) \right] \left[ 1 + \left( \frac{1.12\bar{h}}{r} \right)^2 \right]} \quad (C5.5.2.1.1-23)$$

The value of the relative weight parameter,  $\tilde{w}$ , is likely to be in the neighborhood of 0.15 for typical structures.

**5.5.5.1.2 Effective Damping:** Equation 5.5.5.1.2-1 for the overall damping factor of the elastically supported structure,  $\tilde{\gamma}$ , was determined from analyses of the harmonic response at resonance of simple systems of the type considered in Figures C5.5.1-2 and 5.5.1-3. The result is an expression of the form (Bielak, 1975; Veletsos and Nair, 1975):

$$\tilde{\gamma} = \gamma_o + \frac{8}{\left( \frac{\tilde{T}}{T} \right)^3} \quad (C5.5.2.1.2-1)$$

in which  $\gamma_o$  represents the contribution of the foundation damping, considered in greater detail in the following paragraphs, and the second term represents the contribution of the structural damping. The latter damping is assumed to be of the viscous type. Equation C5.5.5.1.2-1 corresponds to the value of  $\gamma_o = 0.05$  used in the development of the response spectra for rigidly supported systems employed in Sec. 5.3.

The foundation damping factor,  $\gamma_o$ , incorporates the effects of energy dissipation in the soil due to the following sources: the radiation of waves away from the foundation, known as radiation or geometric damping, and the hysteretic or inelastic action in the soil, also known as soil material damping. This factor depends on the geometry of the foundation-soil contact area and on the properties of the structure and the underlying soil deposits.

For mat foundations of circular plan that are supported at the surface of reasonably uniform soils deposits, the three most important parameters which affect the value of  $\gamma_o$  are: the ratio  $T/T_o$  of the fundamental natural periods of the elastically supported and the fixed-base structures, the ratio  $\bar{h}/r$  of the effective height of the structure to the radius of the foundation, and the damping capacity of the

soil. The latter capacity is measured by the dimensionless ratio  $W_s/W_s$ , in which  $W_s$  is the area of the hysteresis loop in the stress-strain diagram for a soil specimen undergoing harmonic shearing deformation and  $W_s$  is the strain energy stored in a linearly elastic material subjected to the same maximum stress and strain (i.e., the area of the triangle in the stress-strain diagram between the origin and the point of the maximum induced stress and strain). This ratio is a function of the magnitude of the imposed peak strain, increasing with increasing intensity of excitation or level of strain.

The variation of  $\gamma_o$  with  $T/T$  and  $h/r$  is given in Figure 5.5.5.1.2 for two levels of excitation. The dashed lines, which are recommended for values of the effective ground acceleration coefficient,  $A_v$ , equal to or less than 0.10, correspond to a value of  $W_s/W_s = 0.3$ , whereas the solid lines, which are recommended for  $A_v$  values equal to or greater than 0.20, correspond to a value of  $W_s/W_s = 1$ . (Note that for the purpose of these evaluations  $A_a$  may be taken as  $0.4 S_{DS}$  and  $A_v$  may be taken as  $S_{DI}$ .) These curves are based on the results of extensive parametric studies (Veletsos, 1977; Veletsos and Meek, 1974; Veletsos and Nair, 1975) and represent average values. For the ranges of parameters that are of interest in practice, however, the dispersion of the results is small.

For mat foundations of arbitrary shape, the quantity  $r$  in Figure 5.5.5.1.2 should be interpreted as a characteristic length that is related to the length of the foundation,  $L_o$ , in the direction in which the structure is being analyzed. For short, squatty structures for which  $h/L_o \leq 0.5$ , the overall damping of the structure-foundation system is dominated by the translational action of the foundation, and it is reasonable to interpret  $r$  as  $r_o$ , the radius of a disk that has the same area as that of the actual foundation (see Eq. 5.5.5.1.1-5). On the other hand, for structures with  $h/L_o \geq 1$ , the interaction effects are dominated by the rocking motion of the foundation, and it is reasonable to define  $r$  as the radius  $r_m$  of a disk whose static moment of inertia about a horizontal centroidal axis is the same as that of the actual foundation normal to the direction in which the structure is being analyzed (see Eq. 5.5.5.1.1-6).

Subject to the qualifications noted in the following section, the curves in Figure 5.5.5.1.2 also may be used for embedded mat foundations and for foundations involving spread footings or piles. In the latter cases, the quantities  $A_o$  and  $I_o$  in the expressions for the characteristic foundation length,  $r$ , should be interpreted as the area and the moment of inertia of the load-carrying foundation.

In the evaluation of the overall damping of the structure-foundation system, no distinction has been made between surface-supported foundations and embedded foundations. Since the effect of embedment is to increase the damping capacity of the foundation (Bielak, 1975; Novak, 1974; Novak and Beredugo, 1972) and since such an increase is associated with a reduction in the magnitude of the forces induced in the structure, the use of the recommended requirements for embedded structures will err on the conservative side.

There is one additional source of conservatism in the application of the recommended requirements to structures with embedded foundations. It results from the assumption that the free-field ground motion at the foundation level is independent of the depth of foundation embedment. Actually, there is evidence to the effect that the severity of the free-field excitation decreases with depth (Seed et al., 1977). This reduction is ignored both in Sec. 5.5 and in the requirements for rigidly supported structures presented in Sec. 5.3 and 5.4.

Equations 5.5.5.1.2-1 and C5.5.5.1.2-1, in combination with the information presented in Figure 5.5.5.1.2, may lead to damping factors for the structure-soil system,  $\tilde{\gamma}$ , that are smaller than the structural damping factor,  $\gamma$ . However, since the representative value of  $\gamma = 0.05$  used in the develop-

ment of the design requirements for rigidly supported structures is based on the results of tests on actual structures, it reflects the damping of the full structure-soil system, not merely of the component contributed by the superstructure. Thus, the value of  $\tilde{\gamma}$  determined from Eq. 5.5.5.1.2-1 should never be taken less than  $\gamma$ , and a low bound of  $\tilde{\gamma} = \gamma = 0.05$  has been imposed. The use of values of  $\tilde{\gamma} > \gamma$  is justified by the fact that the experimental values correspond to extremely small amplitude motions and do not reflect the effects of the higher soil damping capacities corresponding to the large soil strain levels associated with the design ground motions. The effects of the higher soil damping capacities are appropriately reflected in the values of  $\gamma_o$  presented in Figure 5.5.5.1.5.

There are, however, some exceptions. For foundations involving a soft soil stratum of reasonably uniform properties underlain by a much stiffer, rock-like material with an abrupt increase in stiffness, the radiation damping effects are practically negligible when the natural period of vibration of the stratum in shear,

$$T_s = \frac{4D_s}{v_s} \quad (\text{C5.5.2.1.2-2})$$

is smaller than the natural period of the flexibly supported structure,  $T$ . The quantity  $D_s$  in this formula represents the depth of the stratum. It follows that the values of  $\gamma_o$  presented in Figure 5.5.5.1.2 are applicable only when:

$$\frac{T_s}{\tilde{T}} = \frac{4D_s}{v_s \tilde{T}} \leq 1 \quad (\text{C5.5.2.1.2-3})$$

For

$$\frac{T_s}{\tilde{T}} = \frac{4D_s}{v_s \tilde{T}} < 1 \quad (\text{C5.5.2.1.2-4})$$

the effective value of the foundation damping factor,  $\gamma'_o$  is less than  $\gamma_o$ , and it is approximated by the second degree parabola defined by Eq. 5.5.5.1.2-4.

For  $T_s/T = 1$ , Eq. 5.5.5.1.2-4 leads to  $\gamma'_o = \gamma_o$  whereas for  $T_s/T = 0$ , it leads to  $\gamma'_o = 0$ , a value that clearly does not provide for the effects of material soil damping. It may be expected, therefore, that the computed values of  $\gamma'_o$  corresponding to small values of  $T_s/T$  will be conservative. The conservatism involved, however, is partly compensated by the requirement that  $\tilde{\gamma}$  be no less than  $\tilde{\gamma} = \gamma = 0.05$ .

**5.5.5.2 Vertical Distribution of Seismic Forces and 5.5.5.3 Other Effects:** The vertical distributions of the equivalent lateral forces for flexibly and rigidly supported structures are generally different. However, the differences are inconsequential for practical purposes, and it is recommended that the same distribution be used in both cases, changing only the magnitude of the forces to correspond to the appropriate base shear. A greater degree of refinement in this step would be inconsistent with the approximations embodied in the requirements for rigidly supported structures.



With the vertical distribution of the lateral forces established, the overturning moments and the torsional effects about a vertical axis are computed as for rigidly supported structures. The above procedure is applicable to planar structures and, with some extension, to three-dimensional structures. Methods exist for incorporating two- and three-dimensional  $P$ -delta effects into computer analyses that do not explicitly include such effects (Rutenberg, 1985). Many programs explicitly include  $P$ -delta effects. A mathematical description of the method employed by several popular programs is given by Wilson and Habibullah (1987).

The  $P$ -delta procedure cited above effectively checks the static stability of a structure based on its initial stiffness. Since the inception of this procedure in the ATC 3-06 document, however, there has been some debate regarding its accuracy. This debate reflects the intuitive notion that a structure's secant stiffness would more accurately represent inelastic  $P$ -delta effects. Due to the additional uncertainty of the effect of dynamic response on  $P$ -delta behavior and on the (apparent) observation that instability-related failures rarely occur in real structures, the  $P$ -delta requirements as originally written have remained unchanged until now.

There is increasing evidence, however, that the use of inelastic stiffness in determining theoretical  $P$ -delta response is unconservative. Based on a study carried out by Bernal (1987), it can be argued that  $P$ -delta amplifiers should be based on secant stiffness. In other words, the  $C_d$  term in Eq. 5.3.7.2-1 of the *Provisions* should be deleted. Since Bernal's study was based on the inelastic dynamic response of single-degree-of-freedom elastic-perfectly plastic systems, significant uncertainties exist in the extrapolation of the concepts to the complex hysteretic behavior of multi-degree-of-freedom systems.

Another problem with accepting a  $P$ -delta procedure based on secant stiffness is that current design forces would be greatly increased. For example, consider an ordinary moment frame of steel with a  $C_d$  of 4.0 and an elastic stability coefficient,  $\phi$ , of 0.15. The amplifier for this structure would be  $1.0/0.85 = 1.18$  according to the current requirements. If the  $P$ -delta effects were based on secant stiffness, however, the stability coefficient would increase to 0.60 and the amplifier would become  $1.0/0.4 = 2.50$ . (Note that the 0.9 in the numerator of the amplifier equation in the 1988 Edition of the *Provisions* has been dropped for this comparison.) From this example, it can be seen that there could be an extreme impact on the requirements if a change was implemented that incorporated  $P$ -delta amplifiers based on static secant stiffness response.

Nevertheless, there must be some justification for retaining the  $P$ -delta amplifier as based on elastic stiffness. This justification is the apparent lack of stability-related failures. The reasons for the lack of observed failures are, at a minimum, twofold:

1. Many structures display an overstrength well above the strength implied by code-level design forces (see Figure 5.5.1). This overstrength likely protects structures from stability-related failures.
5. The likelihood of a stability failure decreases with the increased intensity of expected ground-shaking. This is due to the fact that the stiffness of most structures designed for extreme ground motion is significantly greater than the stiffness of the same structure designed for lower intensity shaking or for wind. Since damaging low-intensity earthquakes are somewhat rare, there would be little observable damage.

Due to the lack of stability-related failures, therefore, the 1991 Edition of the *Provisions* regarding  $P$ -delta amplifiers has remained unchanged from the 1988 Edition with the exception that the 0.90 factor

in the numerator of the amplifier has been deleted. This factor originally was used to create a transition from cases where  $P$ -delta effects need not be considered ( $\beta > 1.0$ , amplifier  $> 1.0$ ).

Aside from the amplifier, however, the 1991 Edition of the *Provisions* added a new requirement that the computed stability coefficient,  $\beta$ , not exceed 0.25 or  $0.5/C_d$  where  $C_d$  is an adjusted ductility demand that takes into account the fact that the seismic strength demand may be somewhat less than the code strength supplied. The adjusted ductility demand is **not** intended to incorporate overstrength beyond that computed by the means available in Chapters 8 through 14 of the *Provisions*.

The purpose of this new provision is to protect structures from the possibility of stability-related failures triggered by post-earthquake residual deformation. The danger of such failures is real and may not be eliminated by apparently available overstrength. This is particularly true of structures designed in for regions of lower seismicity.

The computation of  $\beta_{max}$ , which in turn is based on  $C_b$ , requires the computation of story strength supply and story strength demand. Story strength demand is simply the seismic design shear for the story under consideration. The story strength supply may be computed as the shear in the story that occurs simultaneously with the attainment of the development of first significant yield of the overall structure. To compute first significant yield, the structure should be loaded with a seismic force pattern similar to that used to compute seismic story strength demand. A simple and conservative procedure is to compute the ratio of demand to strength for each member of the seismic-force-resisting system in a particular story and then use the largest such ratio as  $\beta$ . For a structure otherwise in conformance with the *Provisions*,  $\beta = 1.0$  is obviously conservative.

The principal reason for inclusion of  $\beta$  is to allow for a more equitable analysis of those structures in which substantial extra strength is provided, whether as a result of adding stiffness for drift control, of code-required wind resistance, or simply of a feature of other aspects of the design.

**5.5.3 Modal Analysis Procedure:** Studies of the dynamic response of elastically supported multi-degree-of-freedom systems (Bielak, 1976; Chopra and Gutierrez, 1974; Veletsos, 1977) reveal that, within the ranges of parameters that are of interest in the design of structures subjected to earthquakes, soil-structure interaction affects substantially only the response component contributed by the fundamental mode of vibration of the superstructure. In this section, the interaction effects are considered only in evaluating the contribution of the fundamental structural mode. The contributions of the higher modes are computed as if the structure were fixed at the base, and the maximum value of a response quantity is determined, as for rigidly supported structures, by taking the square root of the sum of the squares of the maximum modal contributions.

The interaction effects associated with the response in the fundamental structural mode are determined in a manner analogous to that used in the analysis of the equivalent lateral force method, except that the effective weight and effective height of the structure are computed so as to correspond exactly to those of the fundamental natural mode of the fixed-base structure. More specifically,  $\bar{W}$  is computed from:

$$\bar{W} = \bar{W}_1 = \frac{(\sum w_i \phi_{i1})^2}{\sum w_i \phi_{i1}^2} \quad (\text{C5.5.3})$$

which is the same as Eq. 5.4.5-2, and  $\tilde{h}$  is computed from Eq. 5.5.3.1-5. The quantity  $\tilde{u}_i$  in these formulas represents the displacement amplitude of the  $i^{\text{th}}$  floor level when the structure is vibrating in its fixed-base fundamental natural mode. The structural stiffness,  $\tilde{k}$ , is obtained from Eq. 5.5.5.1.1-2 by taking  $W = \tilde{W}_i$  and using for  $T$  the fundamental natural period of the fixed-base structure,  $T_f$ . The fundamental natural period of the interacting system,  $T_b$ , is then computed from Eq. 5.5.5.1.1-1 (or Eq. 5.5.5.1.2-4 when applicable) by taking  $T = T_f$ . The effective damping in the first mode,  $\tilde{\gamma}$ , is determined from Eq. 5.5.5.1.2-1 (and Eq. 5.5.5.1.2-4 when applicable) in combination with the information given in Figure 5.5.5.1.5. The quantity  $\tilde{h}$  in the latter figure is computed from Eq. 5.5.3.1-5.

With the values of  $T_b$  and  $\tilde{\gamma}$  established, the reduction in the base shear for the first mode,  $V_b$ , is computed from Eq. 5.5.5.1-5. The quantities  $C_s$  and  $C_b$  in this formula should be interpreted as the seismic coefficients corresponding to the periods  $T_f$  and  $T_b$ , respectively;  $\tilde{\gamma}$  should be taken equal to  $\tilde{\gamma}_b$ ; and  $W$  should be determined from Eq. C5.5.3.

The sections on lateral forces, shears, overturning moments, and displacements follow directly from what has already been noted in this and the preceding sections and need no elaboration. It may only be pointed out that the first term within the brackets on the right side of Eq. 5.5.3.2-1 represents the contribution of the foundation rotation.

**5.5.3.3 Design Values:** The design values of the modified shears, moments, deflections, and story drifts should be determined as for structures without interaction by taking the square root of the sum of the squares of the respective modal contributions. In the design of the foundation, the overturning moment at the foundation-soil interface determined in this manner may be reduced by 10 percent as for structures without interaction.

The effects of torsion about a vertical axis should be evaluated in accordance with the requirements of Sec. 5.3.5 and the  $P$ -delta effects should be evaluated in accordance with the requirements of Sec. 5.3.7.2, using the story shears and drifts determined in Sec. 5.5.3.5.

**Other Methods of Considering the Effects of Soil Structure Interaction:** The procedures proposed in the preceding sections for incorporating the effects of soil-structure interaction provide sufficient flexibility and accuracy for practical applications. Only for unusual structures of major importance, and only when the requirements indicate that the interaction effects are of definite consequence in design, would the use of more elaborate procedures be justified. Some of the possible refinements, listed in order of more or less increasing complexity, are:

1. Improve the estimates of the static stiffnesses of the foundation,  $K_y$  and  $K_x$ , and of the foundation damping factor,  $\gamma$ , by considering in a more precise manner the foundation type involved, the effects of foundation embedment, variations of soil properties with depth, and hysteretic action in the soil. Solutions may be obtained in some cases with analytical or semi-analytical formulations and in others by application of finite difference or finite element techniques (Blaney et al., 1974; Luco, 1974; Novak, 1974; Veletsos and Verbic, 1973). It should be noted, however, that these solutions involve approximations of their own that may offset, at least in part, the apparent increase in accuracy.
2. Improve the estimates of the average properties of the foundation soils for the stipulated design ground motion. This would require both laboratory tests on undisturbed samples from the site and studies of wave propagation for the site. The laboratory tests are needed to establish the actual

variations with shearing strain amplitude of the shear modulus and damping capacity of the soil, whereas the wave propagation studies are needed to establish realistic values for the predominant soil strains induced by the design ground motion.

3. Incorporate the effects of interaction for the higher modes of vibration of the structure, either approximately by application of the procedures recommended in Bielak (1976), Roesset et al. (1973), and Tsai (1974) or by more precise analyses of the structure-soil system. The latter analyses may be implemented either in the time domain by application of the impulse response functions presented in Veletsos and Verbic (1974). However, the frequency domain analysis is limited to systems that respond within the elastic range while the approach involving the use of the impulse response functions is limited, at present, to soil deposits that can adequately be represented as a uniform elastic halfspace. The effects of yielding in the structure and/or supporting medium can be considered only approximately in this approach by representing the supporting medium by a series of springs and dashpots whose properties are independent of the frequency of the motion and by integrating numerically the governing equations of motion (Parmelee et al., 1969).
4. Analyze the structure-soil system by finite element method (Seed et al., 1974 and 1977; Vaish and Chopra, 1974), taking due account of the nonlinear effects in both the structure and the supporting medium.

It should be emphasized that, while these more elaborate procedures may be appropriate in special cases for design verification, they involve their own approximations and do not eliminate the uncertainties that are inherent in the modeling of the structure-foundation-soil system and in the specification of the design ground motion and of the properties of the structure and soil.

## REFERENCES

- Anderson, D. G., and F. E. Richart, Jr. 1976. "Effects of Straining on Shear Modulus of Clays." *Journal of the ASCE Geotechnical Engineering Division* 102 (679):975-987.
- Arias, A., and R. Husid. 1965. "Influence of Damping on Earthquake Response of Structures." *Revista del IDIEM* 1 (3). In Spanish.
- Ballard, R. F., and F. G. McLean. 1975. "Seismic Field Methods for In Situ Moduli." In *Proceedings of the Conference on In Situ Measurement of Soil Properties*, Vol. I, pp. 121-150. North Carolina State University.
- Bernal, D. 1987. "Amplification Factors for Inelastic Dynamic  $P$ -delta Effects in Earthquake Analysis." *Earthquake Engineering and Structural Dynamics*, 15:835-881.
- Bielak, J. 1976. "Modal Analysis for Building-Soil Interaction." *Journal of the ASCE Engineering Mechanics Division* 102 (EM5):771-786.
- Bielak, J. 1975. "Dynamic Behavior of Structures with Embedded Foundations." In *Earthquake Engineering and Structural Dynamics*, Vol. 3, pp. 259-274.
- Blaney, G. W., I. Kausel, and J. M. Roesset. "Dynamic Stiffness of Piles." In *Proceedings of the Second International Conference on Numerical Methods in Geomechanics*, Vol. 2, pp. 1001-1015. Blacksburg: Virginia Polytechnic Institute and State University.
- Bonowitz, D., Youssef, N., and Gross, J. L., "A survey of steel moment-resisting frames buildings affected by the 1994 northridge earthquake," Report no. *NISTIR 5625*, NIST, Gaithersbur, MD, 1995.

- Chopra, A. K., and J. A. Gutierrez. 1974. "Earthquake Analysis of Multistory Buildings Including Foundation Interaction." *Journal of Earthquake Engineering and Structural Dynamics* 3:65-67.
- Clough, R. W. and J. Penzien. 1975. *Dynamics of Structures*. New York: McGraw-Hill.
- Earthquake Engineering Research Institute. 1994. *Preliminary Reconnaissance Report: Northridge Earthquake*, EERI 94-01.
- Elsabee, F., I. Kausel, and J. M. Roesset. 1977. "Dynamic Stiffness of Embedded Foundations." In *Proceedings of the ASCE Second Annual Engineering Mechanics Division Specialty Conference*, pp. 40-43.
- Erden, S. M. 1974. Influence of Shape and Embedment on Dynamic Foundation Response. Thesis submitted in partial fulfillment of the requirements for the degree of Doctor of Philosophy, University of Massachusetts, Amherst.
- Hara, A., T. Ohta, M. Niwa, S. Tanaka, and T. Banno. 1974. "Shear Modulus and Shear Strength of Cohesive Soils." *Journal of the Japanese Society of Soil Mechanics and Foundation Engineering* 14 (3):1-24.
- Hardin, B. O., and Black. 1968. ???
- Hardin, B. O., and V. P. Drnevich. 1975. "Shear Modulus and Damping in Soils: Design Equations and Curves." *Journal of the ASCE Soil Mechanics and Foundation Division* 98 (SM7):667-695.
- Jennings, P. C., and J. Bielak. 1973. "Dynamics of Building-Soil Interaction." *Bulletin of Seismology Society of America* 63 (1):9-48.
- Kausel, E., and J. M. Roesset. 1975. "Dynamic Stiffness of Circular Foundations." *Journal of the ASCE Engineering Mechanics Division* 101 (EM6):771-785.
- Kuribayashi, E., T. Iwasaki, and F. Tatsuoka. 1974. "Effects of Stress Conditions on Dynamic Properties of Sands." *Bulletin of the International Institute of Seismology and Earthquake Engineering* 12:117-130.
- Liu, S. C., and L. W. Fagel. 1971. "Earthquake Interaction by Fast Fourier Transform." *Journal of the ASCE Engineering Mechanics Division* 97 (EM4):1223-1237.
- Luco, J. E. 1974. "Impedance Functions for a Rigid Foundation on a Layered Medium." *Nuclear Engineering and Design* (31):204-217.
- Nair, K., H. Gray, and N. C. Donovan. 1969. *Analysis of Pile Group Behavior*. ASTM Special Technical Publication 44.
- Newmark, N. M., J. A. Blume, and K. K. Kapur. 1973. "Seismic Design Spectra for Nuclear Power Plants." *Journal of the ASCE Power Division* 99 (PO 2):873-889.
- Newmark, N. M., and E. Rosenblueth. 1971. *Fundamentals of Earthquake Engineering*. New York: Prentice-Hall.
- Novak, M. 1974. "Effect of Soil on Structural Response to Wind and Earthquake." In *Earthquake Engineering and Structural Dynamics*, Vol. 3, pp. 79-96.
- Novak, M., and Y. O. Beredugo. 1975. "Vertical Vibrations of Embedded Footings." *Journal of the ASCE Soil Mechanics and Foundations Division* 98 (SM12):1291-1310.

- Novak, M. 1974. "Dynamic Stiffness and Damping of Piles." *Canadian Geotechnical Journal* 11:574-598.
- Parmelee, R. A., D. S. Perelman, and S. L. Lee. 1969. "Seismic Response of Multistory Structures on Flexible Foundations." *Bulletin of the Seismological Society of America* 29:1061-1070.
- Poulos, H. G. and E. H. Davis. 1974. *Elastic Solutions for Soil and Rock Mechanics*. New York: Wiley and Sons.
- Rainer, J. H. 1975. "Simplified Analysis of Dynamic Structure-Ground Interaction." *Canadian Journal of Civil Engineering* 2 (3):345-356.
- Rainer, J. H. 1975. "Damping in Dynamic Structure-Foundation Interaction." *Canadian Geotechnical Journal* 12:13-25.
- Richart, F. E., J. R. Hall, Jr., and R. D. Woods. *Vibrations of Soils and Foundations*. Englewood Cliffs, New Jersey: Prentice-Hall.
- Roesset et al. 1973.
- Rutenburg, A. 1985. "Simplified  $P$ -delta Analysis for Asymmetric Structures." *Journal of the Structural Division, ASCE*, 108(ST9).
- SAC Joint Venture. 1995. *Analytical Investigation of Buildings Affected by the 1994 Northridge Earthquake*, Volumes 1 and 2, SAC 95-04A and B. SAC Joint Venture, Sacramento, CA, 1995.
- Seed, H. B., J. Lysmer, and R. Hwang. 1974. "Soil-Structure Interaction Analysis for Seismic Response." *Journal of the ASCE Geotechnical Engineering Division* 101 (GT5):439-457.
- Seed, H. B., R. V. Whitman, and J. Lysmer. 1977. "Soil-Structure Interaction Effects in the Design of Nuclear Power Plants." In *Structural and Geotechnical Mechanics, A Volume Honoring N. M. Newmark*, edited by W. J. Hall. Englewood Cliffs, New Jersey: Prentice-Hall.
- Stokoe, K. H., II, and R. D. Woods. 1975. "In Situ Shear Wave Velocity by Cross-Hole Method." *Journal of the ASCE Soil Mechanics and Foundations Division* 98 (SM5):443-460.
- Structural Engineers Association of California. 1968, 1973, 1974, 1976, and 1987. *Recommended Lateral Force Requirements and Commentary*. San Francisco: SEAOC.
- Thomson, W. T. 1965. *Vibration Theory and Application*. New York: Prentice-Hall.
- Tsai, N. C. 1974. "Modal Damping for Soil-Structure Interaction." *Journal of the ASCE Engineering Mechanics Division* 100 (EM2):323-341.
- Uang, C-M., "Establishing  $R$  (or  $R_w$ ) and  $C_d$  Factors for Building Seismic Provisions," *Journal of Structural Engineering*, vol 117, no. 1, pp. 19-28, ASCE, 1991.
- Vaish, A. K., and A. K. Chopra. 1974. "Earthquake Finite Element Analysis of Structure-Foundation Systems." *Journal of the ASCE Engineering Mechanics Division* 100 (EM6):1011-1016.
- Veletsos, A. S., and V. V. Nair. 1975. "Seismic Interaction of Structures on Hysteretic Foundations." *Journal of the ASCE Structural Division* 101 (ST1):109-129.
- Veletsos, A. S. 1977. "Dynamics of Structure-Foundation Systems." In *Structural and Geotechnical Mechanics, A Volume Honoring N. M. Newmark*, edited by W. J. Hall, pp. 333-361. Englewood Cliffs, New Jersey: Prentice-Hall.

- Veletsos, A. S., and J. W. Meek. 1974. "Dynamic Behavior of Building Foundation Systems." *Earthquake Engineering and Structural Dynamics* 3 (2):121-138.
- Veletsos, A. S., and B. Verbic. 1973. "Vibration of Viscoelastic Foundations." *Earthquake Engineering and Structural Dynamics* 2 (1): 87-105.
- Veletsos, A. S., and Y. T. Wei. 1971. "Lateral and Rocking Vibration of Footings." *Journal of the ASCE Soil Mechanics and Foundations Division* 97 (SM9):1227-1248.
- Veletsos, A. S., and B. Verbic. 1974. "Basic Response Functions for Elastic Foundations." *Journal of the ASCE Engineering Mechanics Division* 100 (EM2):189-205.
- Wiegel, R. L., Ed. 1970. *Earthquake Engineering*. New York: Prentice-Hall.
- Wilson, E. L., and A. Habibullah. 1987. "Static and Dynamic Analysis of Multi-story Buildings Including *P*-delta Effects." *Earthquake Spectra* 3(2).
- Wood, S. L., "Performance of Reinforced Concrete Buildings During the 1985 Chile Earthquake," *EERI Spectra*, Nov. 1991

## Chapter 6 Commentary

### ARCHITECTURAL, MECHANICAL, AND ELECTRICAL COMPONENTS DESIGN REQUIREMENTS

**6.1 GENERAL:** The general requirements establish minimum design levels for architectural, mechanical, electrical, and other nonstructural systems and components (hereinafter referred to as "components") recognizing occupancy use, occupant load, need for operational continuity, and the interrelation of structural and architectural, mechanical, electrical, and other nonstructural components. Several exemptions are made to the *Provisions*:

1. All components in Seismic Design Category A are exempted because of the lower seismic input for these items
2. All mechanical and electrical components in Seismic Design Categories B and C are exempted if they have an importance factor ( $I_p$ ) equal to 1.00 because of the low acceleration and the classification that they do not contain hazardous substances and are not required to function to maintain life-safety.
3. All components in all Seismic Design Categories, weighing less than 400 pounds (1780 N), and are mounted 4 ft (1.22 m) or less above the floor are exempted if they have an importance factor ( $I_p$ ) equal to 1.00, because they do not contain hazardous substances, are not required to function to maintain life safety, and are not considered to be mounted high enough to be a life-safety hazard if they fell.

The seismic force on any component shall be applied at the center of gravity of the component and shall be assumed to act in any horizontal direction. Vertical forces on architectural components are specified in Sec. 6.1.3. Vertical forces on mechanical and electrical components are specified in Sec. 6.3.2.

In the design and evaluation of support structures and the attachment of the architectural component, flexibility should be considered. Components that are subjected to seismic relative displacements (i.e., components that are connected to both the floor and ceiling level above) should be designed with adequate flexibility to accommodate imposed displacements. In the design and evaluation of equipment support structures and attachments, flexibility will reduce the fundamental frequency of the supported equipment and increase the amplitude of its induced relative motion. This lowering of the fundamental frequency of the supported component often will bring it into the range of the fundamental frequency of the supporting building or into the high energy range of the input motion. In evaluating the flexibility/stiffness of the component attachment, the load path in the components should be considered especially in the region near the anchor points.

Although the components included in Tables 6.2.2 and 6.3.2 are listed separately, significant interrelationships exist among them and should not be overlooked. For example, exterior, nonstructural, spandrel walls may shatter and fall on the streets or walks below seriously hampering accessibility and egress functions. Further, the rupture of one component could lead to the failure of



another that is dependent on the first. Accordingly, the collapse of a single component ultimately may lead to the failure of an entire system. Widespread collapse of suspended ceilings and light fixtures in a building may render an important space or major exit stairway unusable.

Consideration also was given to the design requirements for these components to determine how well they are conceived for their intended functions. Potential beneficial and/or detrimental interactions with the structure were examined. The interrelationship between components and their attachments were surveyed. Attention was given to the performance relative to each other of architectural, mechanical, and electrical components; building products and finish materials; and systems within and without the building structure. It should be noted that the modification of one component in Table 6.2.2 or 6.3.2 could affect another and, in some cases, such a modification could help reduce the risk associated with the interrelated unit. For example, landscaping barriers around the exterior of certain buildings could decrease the risk due to falling debris although this should not be interpreted to mean that all buildings must have such barriers.

The design of components that are in contact with or in close proximity to structural or other nonstructural components must be given special study to avoid damage or failure when seismic motion occurs. An example is where an important element, such as a motor generator unit for a hospital, is adjacent to a nonload-bearing partition. The failure of the partition might jeopardize the motor generator unit and, therefore, the wall should be designed for a performance level sufficient to ensure its stability.

Where nonstructural wall components may affect or stiffen the structural system because of their close proximity, care must be exercised in selecting the wall materials and in designing the intersection details to ensure the desired performance of each component.

**6.1.2 COMPONENT FORCE TRANSFER FACTOR:** It is required that components be attached to the building structure and that all the required attachments be fully detailed in the design documents. These details should take into account the force levels and anticipated deformations expected or designed into the structure.

If an architectural component were to fail during an earthquake, the mode of failure probably would be related to faulty design of the component, interrelationship with another component that fails, interaction with the structural framing, deficiencies in its type of mounting, or inadequacy of its attachments or anchorage. The last is perhaps the most critical when considering seismic safety.

Building components designed without any intended structural function--such as infill walls--may interact with the structural framing and be forced to act structurally as a result of excessive building deformation. The build up of stress at the connecting surfaces or joints may exceed the limits of the materials. Spatial tolerances between such components thus become a governing factor. These requirements therefore emphasize the ductility and strength of the attachments for exterior wall elements and the interrelationship of elements.

Traditionally, mechanical equipment that does not include rotating or reciprocating components (e.g., tanks, heat exchangers) is anchored directly to the building structure. Mechanical and electrical equipment containing rotating or reciprocating components often is isolated from the structure by vibration isolators (rubber-in-shear, springs, air cushions). Heavy mechanical equipment (e.g., large boilers) often is not restrained at all, and electrical equipment other than generators, which are normally

isolated to dampen vibrations, usually is rigidly anchored (e.g., switchgear, motor control centers). The installation of unattached mechanical and electrical equipment should be virtually eliminated for buildings covered by the *Provisions*.

Friction produced solely by the effects of gravity cannot be counted on to resist seismic forces as equipment and fixtures often tend to "walk" due to rocking when subjected to earthquake motions. This often is accentuated by the vertical ground motions. Because frictional resistance cannot be relied upon, positive restraint must be provided for each component.

**6.1.3 SEISMIC FORCES:** The design seismic force is dependent upon the weight of the system or component, the component amplification factor, the component acceleration at point of attachment to the structure, the component importance factor, and the component response modification factor.

The seismic design force equations presented originated with a study and workshop sponsored by the National Center for Earthquake Engineering Research (NCEER) with funding from the National Science Foundation (NSF) (Bachman et al., 1993). The participants examined recorded acceleration data in response to strong earthquake motions. The objective was to develop a "supportable" design force equation that considered actual earthquake data as well as component location in the structure, component anchorage ductility, component importance, component safety hazard upon separation from the structure, structural response, site conditions, and seismic zone. Additional studies have further revised the equation to its present form (Drake and Bachman, 1994 and 1995). In addition, the term  $C_a$  has been replaced by the quantity  $0.4S_{DS}$  to conform with changes in Chapter 4. BSSC Technical Subcommittee 8 believes that Eq. 6.1.3-1 through 6.1.3-3 achieve the objectives without unduly burdening the practitioner with complicated formulations.

The component amplification factor ( $a_p$ ) represents the dynamic amplification of the component relative to the fundamental period of the structure ( $T$ ). It is recognized that at the time the components are designed or selected, the structural fundamental period is not always defined or readily available. It is also recognized that the component fundamental period ( $T_p$ ) is usually only accurately obtained by expensive shake-table or pull-back tests. A listing is provided of  $a_p$  values based on the expectation that the component will usually behave in either a rigid or flexible manner. In general, if the fundamental period of the component is less than 0.06 sec, no dynamic amplification is expected. It is not the intention of the *Provisions* to preclude more accurate determination of the component amplification factor when reasonably accurate values of both the structural and component fundamental periods are available. Figure C 6.1.3-1 is from the NCEER work and is an acceptable formulation for  $a_p$  as a function of  $T_p/T$ . Minor adjustments from the 1994 *Provisions* have been made in the tabulated  $a_p$  values to be consistent with the 1997 *Uniform Building Code*.

The component response modification factor ( $R_p$ ) represents the energy absorption capability of the component's structure and attachments. Conceptually, the  $R_p$  value considers both the overstrength and deformability of the component's structure and attachments. In the absence of

current research, it is believed these separate considerations can be adequately combined into a single factor. The engineering community is encouraged to address the issue and conduct research into the component response modification factor that will advance the state of the art. These values are judgmentally determined utilizing the collective wisdom and experience of the responsible committee. In general, the following benchmark values were used:

- $R_p = 1.25$ , low deformability element
- $R_p = 2.5$ , limited deformability element
- $R_p = 3.5$ , high deformability element

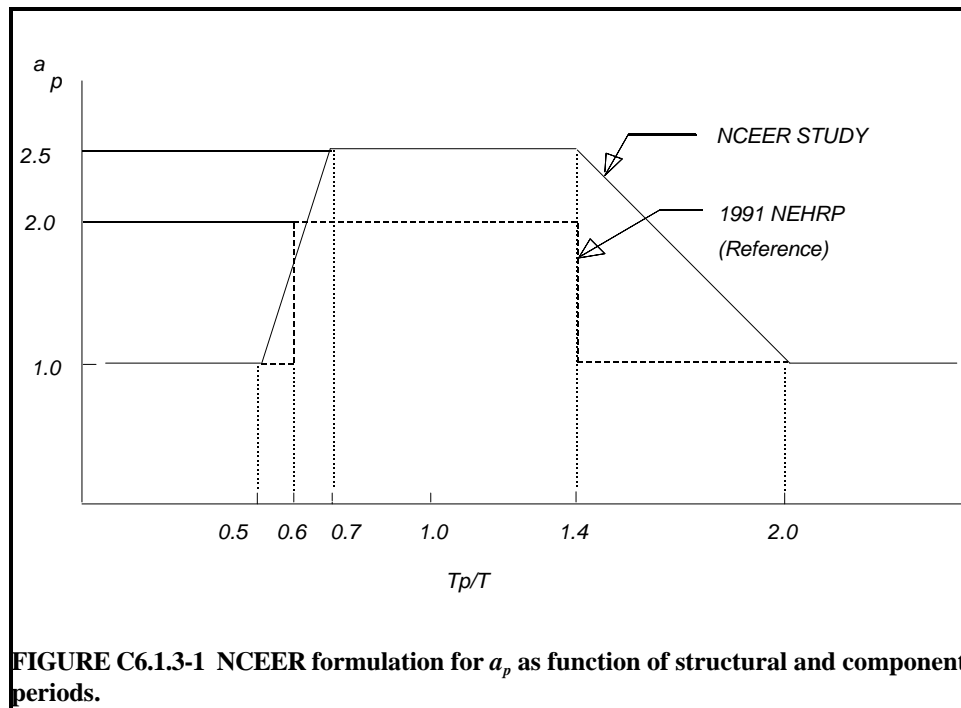

Minor adjustments from the 1994 *Provisions* have been made in the tabulated  $R_p$  values to correlate with  $F_p$  values determined in accordance with the 1997 *Uniform Building Code*. Researchers have proposed a procedure for validating values for  $R_p$  with respect to documented earthquake performance (Bachman and Drake, 1996).

Eq. 6.1.3-1 represents a trapezoidal distribution of floor accelerations within the structure, linearly varying from the acceleration at the ground ( $0.4S_{DS}$ ) to the acceleration at the roof ( $1.2S_{DS}$ ). The ground acceleration ( $0.4S_{DS}$ ) is intended to be the same acceleration used as design input for the structure itself and will include site effects.

Examination of recorded in-structure acceleration data in response to large California earthquakes reveals that a reasonable maximum value for the roof acceleration is four times the input ground acceleration to the structure. Earlier work (Drake and Bachman, 1996, 1995 and 1996) indicated that the maximum amplification factor of four seems suitable (Figure C6.1.3-1). However, a close examination of recently recorded strong motion data at sites with peak ground accelerations in excess

of 0.1g indicates that an amplification factor of three is more appropriate (Figure C 6.1.3-2). In the lower portions of the structure (the lowest 20 percent of the structure), both the amplification factors of three and four do not bound the mean plus one standard deviation accelerations. However, the minimum design force in Eq. 6.1.3-3 provides a lower bound in this region.

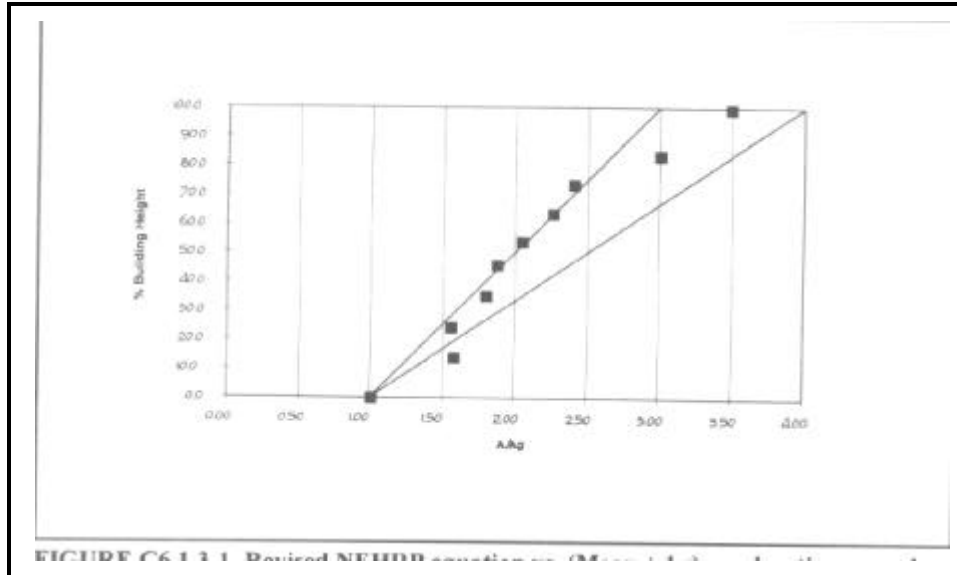

FIGURE C6.1.3-1 Revised NEHRP equation vs. (Mean + 1 ) acceleration records -- all sites.

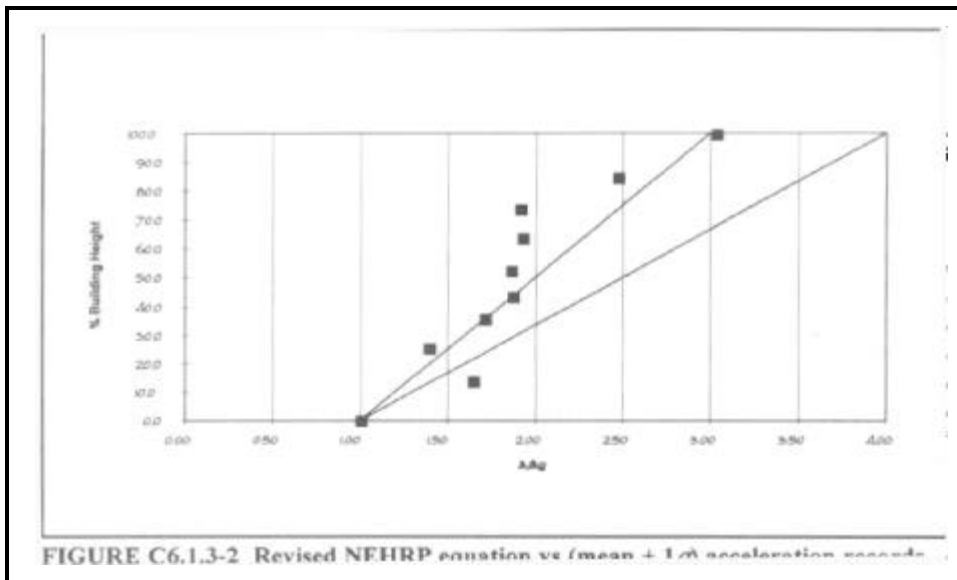

FIGURE C6.1.3-2 Revised NEHRP equation vs (mean + 1 ) acceleration records -- sites with  $A_g = 0.1g$ .

Examination of the same data indicates that the in-structure accelerations do not decrease with larger building periods as might be expected from reviewing typical response spectra. One reason for invalidating the traditional response spectra shape might be that structures with longer fundamental periods may have designs governed by drift requirements. These structures would be stiffer with more elastic capacity and also may have lower damping at higher acceleration responses. Also, site soil amplifications are greater at longer periods than at shorter periods. As a result of these studies, the structural period effect introduced into the 1994 *Provisions* for components has been removed from the 1997 *Provisions*.

A lower limit for  $F_p$  is set to assure a minimal seismic design force. The minimum value for  $F_p$  determined by setting the quantity  $a_p A_p / R_p$  equal to  $0.7 C_a$  which is equivalent to the minimum used in current practice. In addition, the  $C_a$  term was converted to  $0.4 S_{DS}$  to be consistent with changes to Chapter 1. The resultant multiplication of 0.7 times 0.4 equals 0.28 was rounded to 0.3 for simplicity.

To meet the need for a simpler formulation, a conservative maximum value for  $F_p$  also was set. Eq. 6.1.3-2 is the maximum value for  $F_p$  determined by setting the quantity  $a_p A_p / R_p$  equal to 4.0. In addition, the term  $C_a$  was converted to  $0.4 S_{DS}$  to be consistent with changes to Chapter 4. Eq. 6.1.3-2 also serves as a reasonable "cutoff" equation to assure that the multiplication of the individual factors does not yield an unreasonably high design force.

To clarify the application of vertical seismic design forces in combination with horizontal design forces and service loads, a cross-reference was provided to Sec. 2.2.6. The value for  $F_p$  calculated in accordance with Chapter 6 should be substituted for the value of  $Q_E$  in Sec. 2.2.6.

**6.1.4 SEISMIC RELATIVE DISPLACEMENTS:** The seismic relative displacement equations were developed as part of the NCEER/NSF study and workshop described above. It was recognized that displacement equations were needed to support the design of cladding, stairwells, windows, piping systems, sprinkler components, and other components that are connected to the structure(s) at multiple levels or points of connection.

Two equations are given for each situation. Eq. 6.1.4-1 and Eq. 6.1.4-3 yield "real" structural displacements as determined by elastic analysis, with no structural response modification factor ( $R$ ) included. Recognizing that elastic displacements are not always defined or available at the time the component is designed or procured, default Eq. 6.1.4-2 and Eq. 6.1.4-4 also are provided that allow the use of structure drift limitations. Use of these default equations must balance the need for a timely component design/procurement with the possible conservatism of their use. It is the intention that the lesser of the paired equations be acceptable for use.

The designer also should consider other situations where seismic relative displacements could impose unacceptable stresses on a component or system. One such example would be a component connecting two pieces of equipment mounted in the same building at the same elevation, where each piece of equipment has its own displacements relative to the mounting location. In this case, the designer must accommodate the total of the separate seismic displacements relative to the equipment mounting location.

For some items such as ductile piping, relative seismic displacements between support points generally are of more significance than forces. Piping made of ductile materials such as steel or copper can

accommodate relative displacements by local yielding but with strain accumulations well below failure levels. However, components made of less ductile materials can only accommodate relative displacement effects by use of flexible connections or avoiding local yielding. It is further the intent of the *Provisions* to consider the effects of seismic support relative displacements and displacements caused by seismic force on mechanical and electrical component assemblies such as piping systems, cable and conduit systems, and other linear systems, most typically, and the equipment to which they attach. Impact of components should also be avoided although ductile materials have been shown to be capable of accommodating fairly significant impact loads. With protective coverings, ductile mechanical and electrical components and many more fragile components can be expected to survive all but the most severe impact loads.

**6.1.5 COMPONENT IMPORTANCE FACTOR:** The component importance factor ( $I_p$ ) represents the greater of the life-safety importance of the component and the hazard exposure importance of the structure. This factor indirectly accounts for the functionality of the component or structure by requiring design for a higher force level. Use of higher  $I_p$  requirements together with application of the requirements in Sec. 6.3.13 and 6.3.14 should provide a better, more functional component. While this approach will provide a higher degree of confidence in the probable seismic performance of a component, it may not be sufficient for all components. For example, individual ceiling tiles may still fall from the ceiling grid. Seismic qualification approaches presently in use by the Department of Energy (DOE) and the Nuclear Regulatory Commission (NRC) should be considered by the registered design professional and/or the owner when unacceptable consequences of failure are anticipated.

Components that may fall from the structure are among the most hazardous building elements in an earthquake. These components may not be integral with the structural system and may cantilever horizontally or vertically from their supports. Critical issues affecting these components include their weight, their attachment to the structure, and their location (over an entry or exit, public walkway, atrium, or lower adjacent structure). Examples of items that may pose a falling hazard include parapets, cornices, canopies, marquees, and precast concrete cladding panels. In addition, mechanical and electrical components may pose a falling hazard, for example, a rooftop tank or cooling tower, which if separated from the structure, will fall to the ground.

Special consideration should be given components that could block means of egress or exitways apply to items that, if they fall during an earthquake, could block the means of egress for the occupants of the structure. The term "means of egress" has been defined the same way throughout the country, since egress requirements have been included in building codes because of fire hazard. The requirements for exitways include intervening aisles, doors, doorways, gates, corridors, exterior exit balconies, ramps, stairways, pressurized enclosures, horizontal exits, exit passage ways, exit courts, and yards. Example items that should be included when considering egress include walls around stairs, corridors, veneers, cornices, canopies, and other ornaments above building exits. In addition, heavy partition systems vulnerable to failure by collapse, ceilings, soffits, light fixtures, or other objects that could fall or obstruct a required exit. door or component (rescue window or fire escape) could be considered major obstructions. Examples of the components that do not pose a significant falling hazard include fabric awnings and canopies and architectural, mechanical, and electrical components which, if separated from the structure, will fall in areas that are not accessible (in an atrium or light well not accessible to the public for instance).

Sec. 1.3.1 requires that Group III structures shall, in so far as practical, be provided with the capacity to function after an earthquake. To facilitate this, all nonstructural components and equipment in structures in Seismic Use Group III, and in Seismic Design Category C or higher, should be designed with an  $I_p$  equal to 1.5. All components and equipment are included because damage to vulnerable unbraced systems or equipment may disrupt operations following an earthquake, even if they are not "life-safety" items. Nonessential items can be considered "black boxes." There is no need for component analysis as discussed in Sec. 6.3.13 and 6.3.14, since operation of these secondary items is not critical to the post-earthquake operability of the structure.

Until recently, storage racks were primarily installed in low-occupancy ware houses. With the recent proliferation of warehouse-type retail stores, it has been judged necessary to address the relatively greater seismic risk that storage racks may pose to the general public, compared to more conventional retail environments. Under normal operating conditions, retail stores have a far higher occupancy load than an ordinary warehouse of a reasonable size. Failure of a storage rack system in the retail environment is much more likely to cause personal injury than a similar failure in a storage warehouse. Therefore, to provide an appropriate level of additional safety in areas open to the public, Sec 6.1.5 now requires that storage racks in occupancies open to the general public should be designed with an  $I_p$  value equal to 1.50. Storage rack contents, while beyond the scope of the *Provisions* pose a potentially serious threat to life should they fall from the shelves in an earthquake. Restraints should be provided to prevent the contents of rack shelving open to the general public from falling in strong ground shaking.

**6.1.5 COMPONENT ANCHORAGE:** In general, it is not recommended that anchors be relied upon for energy dissipation. Inasmuch as the anchor represents the transfer of load from a relatively deformable material (e.g., steel) to a low deformability material (e.g., concrete, masonry), the boundary conditions for ensuring deformable, energy-absorbing behavior in the anchor itself are at best difficult to achieve. On the other hand, the concept of providing a fuse, or deformable link, in the load path to the anchor is encouraged. This approach allows the designer to provide the necessary level of ductility and overstrength in the connection while at the same time protecting the anchor from overload and eliminates the need for balancing of steel strength and deformability in the anchor with variable edge distances and anchor spacings.

Allowable loads for anchors should not be increased for earthquake loading. Possible reductions in allowable loads for particular anchor types to account for loss of stiffness and strength should be determined through appropriate dynamic testing.

Anchors that are used to support towers, masts, and equipment often are provided with double nuts to allow for leveling during installation. Where baseplate grout is provided, it should not be relied upon to carry loads since it can shrink and crack or is often omitted altogether. In this case, the anchors are loaded in tension, compression, shear, and flexure and should be designed as such.

Prying forces on anchors, which result from a lack of rotational stiffness in the connected part, can be critical for anchor design and must be considered explicitly.

For anchorages that are not provided with a mechanism to transfer compression loads, the design for overturning must reflect the actual stiffness of the baseplate, equipment, housing, etc., in determining the location of the compression centroid and the distribution of uplift loads to the anchors.

Possible reductions in allowable loads for particular anchor types to account for loss of stiffness and strength should be determined through appropriate dynamic testing.

While the requirements do not prohibit the use of single anchor connections, it is considered necessary to use at least two anchors in any load-carrying device whose failure might lead to collapse.

Tests have shown that there are consistent shear ductility variations between bolts anchored to drilled or punched plates with nuts and connections using welded, headed studs. Recommendations for design are not presently available but should be considered in critical connections subject to dynamic or seismic loading.

It is important to relate the anchorage demands defined by Chapter 6 with the material capacities defined in the other chapters.

**6.1.6.5:** Generally, powder driven fasteners in concrete tend to exhibit variations in load capacity that are somewhat larger than post-drilled anchors and do not provide the same levels of reliability even though some installation methods allow for the same reliability as post-drilled expansion anchors. As such, their qualification under a simulated seismic test program should be demonstrated prior to use. Such fasteners, when properly installed in steel, are reliable, showing high capacities with very low variability.

**6.1.7 CONSTRUCTION DOCUMENTS:** It is deemed important by the committee that there be a clearly defined basis for each quality assurance activity specified in Chapter 3. As result *construction documents* are required for all components requiring special inspection or testing in Chapter 3.

It is also deemed important by the committee that there be some reasonable level of assurance that the construction and installation of components be consistent with the basis of the supporting seismic design. Of particular concern are systems involving multiple trades and suppliers. In these cases, it is important that a registered design professional prepare construction documents for the use by the multiple trades and suppliers to follow in the course of construction.

## **6.2 ARCHITECTURAL COMPONENT DESIGN:**

**6.2.1 GENERAL:** The primary focus of the *Provisions* is on the design of attachments, connections, and supports for architectural components.

"Attachments" are means by which components are secured or restrained to the seismic force resisting system of the structure. Such attachments and restraints may include anchor bolting, welded connections, and fasteners.

"Architectural component supports" are those members or assemblies of members, including braces, frames, struts and attachments, that transmit all loads and forces between the component and the building structure. Architectural component supports also transmit lateral forces and/or provide structural stability for the component to which they connect.

The requirements are intended to reduce the threat of life safety hazards posed by components and elements from the standpoint of stability and integrity. There are several circumstances where such components may pose a threat.

1. Where loss of integrity and/or connection failure under seismic motion poses a direct hazard in that the components may fall on building occupants.



2. Where loss of integrity and/or connection failure may result in a hazard for people outside of a building in which components such as exterior cladding and glazing may fall on them.
3. Where failure or upset of interior components may impede access to a required exit.

The requirements are intended to apply to all of the circumstances listed above. Although the safety hazard posed by exterior cladding is obvious, judgment may be needed in assessing the extent to which the requirements should be applied to other hazards.

Property loss through damage to architectural components is not specifically addressed in the *Provisions*. Function and operation of a building also may be affected by damage to architectural components if it is necessary to cease operations while repairs are undertaken. In general, requirements to improve life-safety also will reduce property loss and loss of building function.

In general, functional loss is more likely to be affected by loss of mechanical or electrical components. Architectural damage, unless very severe, usually can be accommodated on a temporary basis. Very severe architectural damage results from excessive structural response that often also results in significant structural damage and building evacuation.

**6.2.2 ARCHITECTURAL COMPONENT FORCES:** Components that could be damaged or could damage other components and are fastened to multiple locations of a structure should be designed to accommodate seismic relative displacements. Examples of components that should be designed to accommodate seismic relative displacements include glazing, partitions, stairs, and veneer.

Certain types of veneer elements, such as aluminum or vinyl siding and trim, possess high deformability. These systems are generally light and can undergo large deformations without separating from the structure. However, care must be taken when designing these elements to ensure that the low deformability components that may be part of the curtain wall system, such as glazing panels, have been detailed to accommodate the expected deformations without failure.

**6.2.3 ARCHITECTURAL COMPONENT DEFORMATION:** Specific requirements for cladding are provided. Glazing, both exterior and interior, and partitions must be capable of accommodating story drift without causing a life-safety hazard. Design judgment must be used with respect to the assessment of life-safety hazard and the likelihood of life-threatening damage. Special detailing to accommodate drift for typical replaceable gypsum board or demountable partitions is not likely to be cost-effective, and damage to these components has a low life-safety hazard. Nonstructural fire-resistant enclosures and fire-rated partitions may require some special detailing to ensure that they retain their integrity. Special detailing should provide isolation from the adjacent or enclosing structure for deformation equivalent to the calculated drift (relative displacement). In-plane differential movement between structure and wall is permitted. Provision also must be made for out-of-plane restraint. These requirements are particularly important in relation to the larger drifts experienced in steel or concrete moment frame structures. The problem is less likely to be encountered in stiff shear wall structures.

Differential vertical movement between horizontal cantilevers in adjacent stories (i.e., cantilevered floor slabs) has occurred in past earthquakes. The possibility of such effects should be considered in design of exterior walls.

**6.2.4 EXTERIOR NONSTRUCTURAL WALL ELEMENTS AND CONNECTIONS:** The *Provisions* requires that nonbearing wall panels that are attached to or enclose the structure shall be designed to resist the (inertial) forces and shall accommodate movements of the structure resulting from lateral forces or temperature change. The force requirements often overshadow the importance of allowing thermal movement and may therefore require special detailing in order to prevent moisture penetration and allow thermal movements.

Connections should be designed such that, if they were to yield, they would do so in a high deformation manner without loss of load-carrying capacity. Between points of connection, panels should be separated from the building structure to avoid contact under seismic action.

The *Provisions* document requires allowance for story drift. This required allowance can be 2 in. (51 mm) or more from one floor to the next and may present a greater challenge to the registered design professional than requirements for the forces. In practice, separations between panels are usually limited to about 3/4 in. (19 mm), with the intent of limiting contact, and hence panel alignment disruption and/or damage under all but extreme building response, and providing for practical joint detailing with acceptable appearance. The *Provisions* calls for a minimum separation of 1/2 in. (13 mm). The design should respect the manufacturing and construction tolerances of the materials used to achieve this dimension.

If wind loads govern, connectors and panels should allow for not less than two times the story drift caused by wind loads determined using a return period appropriate to the site location.

The *Provisions* requirements are in anticipation of frame yielding to absorb energy. The isolation can be achieved by using slots, but the use of long rods that flex is preferable because this approach is not dependent on installation precision to achieve the desired action. The rods must be designed to carry tension and compression in addition to induced flexural stresses. For floor-to-floor wall panels, the panel usually is rigidly fixed to and moves with the floor structure nearest the panel bottom. In this condition, the upper attachments become isolation connections to prevent building movement forces from being transmitted to the panels, and thus the panel translates with the load supporting structure. The panel also can be supported at the top with the isolation connection at the bottom.

When determining the length of slot or displacement demand for the connection, the cumulative effect of tolerances in the supporting frame and cladding panel must be considered.

The *Provisions* requires that fasteners be designed for approximately 4 times the required panel force and that the connecting member be ductile. This is intended to ensure that the energy absorption takes place in the connecting member and not at the connection itself and that the more brittle fasteners remain essentially elastic under seismic loading. The factor of 4 has been incorporated into the  $a_p$  and  $R_p$  factors in consideration of installation and material variability.

To minimize the effects of thermal movements and shrinkage on architectural cladding panels, the connection system generally is statically determinant. As a result, cladding panel support systems often lack redundancy and failure of a single connection can have catastrophic consequences.

**6.2.5 OUT-OF-PLANE BENDING:** Most walls are subject to out-of-plane forces when a building is subjected to an earthquake. These forces and the bending they induce must be considered in the design of wall panels, nonstructural walls, and partitions. This is particularly important for systems composed of brittle materials and/or low flexural strength materials. The conventional limits based

upon deflections as a proportion of the span may be used with the applied force as derived in Sec. 6.2.2.

Judgment must be used in assessing the deflection capability of the component. The intent is that a heavy material (such as concrete block) or an applied finish (such as brittle heavy stone or tile) should not fail in a hazardous manner as a result of out-of-plane forces. Deflection in itself is not a hazard. A steel-stud partition might suffer considerable deflection without creating a hazard; but if the same partition supports a marble facing, a hazard might exist and special detailing may be necessary.

**6.2.6 SUSPENDED CEILINGS:** Suspended ceiling systems usually are fabricated using a wide range of building materials with individual components having different material characteristics. Some systems are homogeneous whereas others incorporate suspension systems with acoustic tile or lay-in panels. Seismic performance during recent large California earthquakes has raised two concerns:

- a. The support of the individual panels at walls and expansion joints and
- b. The interaction with fire sprinkler systems.

The alternate methods provided have been developed in a cooperative effort by registered design professionals, the ceiling industry, and the fire sprinkler industry in an attempt to address these concerns. It is hoped that further research and investigation will result in further improvements in future editions of the *Provisions*.

Consideration shall be given to the placement of seismic bracing and the relation of light fixtures and other loads placed into the ceiling diaphragm and the independent bracing of partitions in order to effectively maintain the performance characteristics of the ceiling system. The ceiling system may require bracing and allowance for the interaction of components.

Dynamic testing of suspended ceiling systems constructed according to the requirements of current industry seismic standards (*UBC Standard 25-2*) performed by ANCO Engineers, Inc. (1983) has demonstrated that the splayed wire even with the vertical compression strut may not adequately limit lateral motion of the ceiling system due to the flexibility introduced by the straightening of the wire end loops. In addition, splay wires usually are installed slack to prevent unleveling of the ceiling grid and to avoid above-ceiling utilities. Not infrequently, bracing wires are omitted because of obstructions. Testing also has shown that system performance without splayed wires or struts was good if adequate width of closure angles and penetration clearance was provided.

The lateral seismic restraint for a nonrigidly braced suspended ceiling is primarily provided by the ceiling coming in contact with the perimeter wall. The wall provides a large contact surface to restrain the ceiling. The key to good seismic performance is that the width of the closure angle around the perimeter is adequate to accommodate ceiling motion and that penetrations, such as columns and piping, have adequate clearance to avoid concentrating restraining loads on the ceiling system. The behavior of an unbraced ceiling system is similar to that of a pendulum; therefore, the lateral displacement is approximately proportional to the level of velocity-controlled ground motion and the square root of the suspension length. Therefore, a new section has been added that permits exemption from force calculations if certain displacement criteria are met. The default displacement limit has been determined based on anticipated damping and energy absorption of the suspended ceiling system assuming minimal significant impact with the perimeter wall.

**6.2.7 ACCESS FLOORS:** Performance of computer access floors during past earthquakes and during cyclic load tests indicate that typical raised access floor systems may behave in a brittle manner and exhibit little reserve capacity beyond initial yielding or failure of critical connections. Recent testing indicates that individual panels may "pop out" of the supporting grid during seismic motions. Consideration should be given to mechanically fastening the individual panels to the supporting pedestals or stringers in egress pathways.

It is acceptable practice for systems with floor stringers to calculate the seismic force  $F_p$  for the entire access floor system within a partitioned space and then distribute the total force to the individual braces or pedestals. Stringerless systems need to be evaluated very carefully to ensure a viable seismic load path.

Overtopping effects for the design of individual pedestals is a concern. Each pedestal usually is specified to carry an ultimate design vertical load greatly in excess of the  $W_p$  used in determining the seismic force  $F_p$ . It is nonconservative to use the design vertical load simultaneously with the design seismic force when considering anchor bolts, pedestal bending, and pedestal welds to base plate. The maximum concurrent vertical load when considering overturning effects is therefore limited to the  $W_p$  used in determining  $F_p$ . "Slip on" heads are not mechanically fastened to the pedestal shaft and provide doubtful capacity to transfer overturning moments from the floor panels or stringers to the pedestal.

To preclude brittle failure behavior, each element in the seismic load path must demonstrate the capacity for elastic or inelastic energy absorption. Buckling failure modes also must be prevented. Lesser seismic force requirements are deemed appropriate for access floors designed to preclude brittle and buckling failure modes.

**6.2.8 PARTITIONS:** Partitions are sometimes designed to run only from floor to a suspended ceiling which provides doubtful lateral support. Partitions subject to these requirements must have independent lateral support bracing from the top of the partition to the building structure or to a substructure attached to the building structure.

**6.2.9 STEEL STORAGE RACKS:** Storage racks are considered nonbuilding structures and are covered in *Provisions* Chapter 14. See *Commentary* Sec. 14.3.3.

### **6.3 MECHANICAL AND ELECTRICAL COMPONENT DESIGN:**

**6.3.1 GENERAL:** The primary focus of these requirements is on the design of attachments and equipment supports for mechanical and electrical components.

The requirements are intended to reduce the hazard to life posed by the loss of component structural stability or integrity. The requirements should increase the reliability of component operation but do not directly address the assurance of functionality.

The design of mechanical and electrical components must consider two levels of earthquake safety. For the first safety level, failure of the mechanical or electrical component itself poses no significant hazard. In this case, the only hazard posed by the component is if the support and the means by which the component and its supports are attached to the building or the ground fails and the component could slide, topple, fall, or otherwise move in a manner that creates a hazard for persons nearby. In the first category, the intent of these requirements is only to design the support and the means by which the component is attached to the structure, defined in the Glossary as "equipment supports" and

"attachments." For the second safety level, failure of the mechanical or electrical equipment itself poses a significant hazard. In this case, failure could either be to a containment having hazardous contents or contents required after the earthquake or failure could be functional to a component required to remain operable after an earthquake. In this second category, the intent of these requirements is to provide guidance for the design of the component as well as the means by which the component is supported and attached to the structure. The requirements should increase the survivability of this second category of component but the assurance of functionality may require additional considerations.

Examples of this second category include fire protection piping or an uninterruptible power supply in a hospital. Another example involves the rupture of a vessel or piping that contains sufficient quantities of highly toxic or explosive substances such that a release would be hazardous to the safety of building occupants or the general public. In assessing whether failure of the mechanical or electrical equipment itself poses a hazard, certain judgments may be necessary. For example, small flat-bottom tanks themselves may not need to be designed for earthquake loads; however, numerous seismic failures of large flat-bottom tanks and the hazard of a large fluid spill suggest that many, if not most, of these should be. Distinguishing between large and small, in this case, may require an assessment of potential damage caused by a spill of the fluid contents over and above the guidance offered in Sec. 6.3.9.

It is intended that the requirements provide guidance for the design of components for both conditions in the second category. This is primarily accomplished by increasing the design forces with an importance factor,  $I_p$ . However, this only affects structural integrity and stability directly. Function and operability of mechanical and electrical components may only indirectly be affected by increasing design forces. For complex components, testing or experience may be the only reasonable way to improve the assurance of function and operability. On the basis of past earthquake experience, it may be concluded that if structural integrity and stability are maintained, function and operability after an earthquake will be reasonably provided for most types of equipment components. On the other hand, mechanical joints in containment components (tanks, vessels, piping, etc.) may not remain leaktight in an earthquake even if after the earthquake leaktightness is re-established. Judgment may suggest a more conservative design related in some manner to the perceived hazard than would otherwise be provided by these requirements.

It is not intended that all equipment or parts of equipment be designed for seismic forces.

Determination of whether these requirements need to be applied to the design of a specific piece of equipment or a part of that equipment will sometimes be a difficult task. Damage to or even failure of a piece or part of a component is not a concern of these requirements so long as a hazard to life does not exist. Therefore, the restraint or containment of a falling, breaking, or toppling component or its parts by the use of bumpers, braces, guys, wedges, shims, tethers, or gapped restraints often may be an acceptable approach to satisfying these requirements even though the component itself may suffer damage. Judgment will be required if the intent of these requirements is to be fulfilled. The following example may be helpful: Since the threat to life is a key consideration, it should be clear that a nonessential air handler package unit that is less than 4 ft (1.2 m) tall bolted to a mechanical room floor is not a threat to life as long as it is prevented from significant motions by having adequate anchorage. Therefore, earthquake design of the air handler itself need not be performed. However, most engineers would agree that a 10-ft (3.0 m) tall tank on 6-ft (1.8 m) angles used as legs mounted on the roof near a building exit does pose a hazard. It is the intent of these requirements that the tank legs, the connections between the roof and the legs, the connections between the legs and the tank, and possibly

even the tank itself be designed to resist earthquake forces. Alternatively, restraint of the tank by guys or bracing could be acceptable.

It is not the intent of the *Provisions* to require the seismic design of shafts, buckets, cranks, pistons, plungers, impellers, rotors, stators, bearings, switches, gears, nonpressure retaining casings and castings, or similar items. When the potential for a hazard to life exists, it is expected that design efforts will focus on equipment supports including base plates, anchorages, support lugs, legs, feet, saddles, skirts, hangers, braces, or ties.

Many mechanical and electrical components consist of complex assemblies of mechanical and/or electrical parts that typically are manufactured in an industrial process that produces similar or identical items. Such equipment may include manufacturer's catalog items and often are designed by empirical (trial-and-error) means for functional and transportation loadings. A characteristic of such equipment is that it may be inherently rugged. Rugged, as used herein, refers to an amplexness of construction that renders such equipment the ability to survive strong motions without significant loss of function. By examining such equipment, an experienced design professional usually should be able to confirm such ruggedness. The results of equipment ruggedness assessment then will determine the need for an appropriate method and extent of the seismic design or qualification efforts.

It also is recognized that a number of professional and industrial organizations have developed nationally recognized codes and standards for the design and construction of specific mechanical and electrical components. In addition to providing design guidance for normal and upset operating conditions and various environmental conditions, some have developed earthquake design guidance in the context of the overall mechanical or electrical design. It is the intent of these requirements that such codes and standards having earthquake design guidance be used as it is to be expected that the developers have a greater familiarity with the expected failure modes of the components for which their design and construction rules are developed. In addition, even if such codes and standards do not have earthquake design guidance, it is generally regarded that construction of mechanical and electrical equipment to nationally recognized codes and standards such as those approved by the American National Standards Institute provide adequate strength (with a safety margin often greater than that provided by structural codes) to accommodate all normal and upset operating loads. In this case, it could also be assumed that the component has sufficient strength (especially if constructed of ductile materials) to not break up or break away from its supports in such a way as to provide a life-safety hazard. Earthquake damage surveys confirm this.

Specific guidance for selected components or conditions is provided in Sec. 6.3.6 through 6.3.16.

**6.3.2 MECHANICAL AND ELECTRICAL COMPONENT FORCES AND DISPLACEMENTS:** Components that could be damaged or could damage other components and are fastened to multiple locations of a structure should be designed to accommodate seismic relative displacements. Examples of components that should be designed to accommodate seismic relative displacements include bus ducts, cable trays, conduit, elevator guide rails, and piping systems.

The restriction on  $R_p$  values in the footnote to Table 6.3.2 is because of the concern for low deformation failure modes in the component anchorage. Anchorages that could be reasonably expected to fail in a low deformation manner should be designed using  $R_p = 1.5$ . Chemical anchors and cast-in-place anchor bolts with an embedment length-to-diameter ratio of 8 or less should be

considered to be "shallow" anchors. Vibration isolator bumper restraints or snubbers should be designed for the impact load imparted when it is engaged.

See also *Commentary* Sec. 6.3.1 for a discussion of deformability.

**6.3.3 MECHANICAL AND ELECTRICAL COMPONENT PERIOD:** Determination of the fundamental period of an item of mechanical or electrical equipment using analytical or in-situ testing methods can become very involved and can produce nonconservative results (i.e., underestimated fundamental periods) if not properly performed.

When using analytical methods, it is absolutely essential to define in detail the flexibility of the elements of the equipment base, load path, and attachment to determine  $K_p$ . This base flexibility typically dominates equipment component flexibility and thus fundamental period.

When using test methods, it is necessary to ensure that the dominant mode of vibration of concern for seismic evaluation is excited and captured by the testing. This dominant mode of vibration typically cannot be discovered in equipment in-situ tests that measure only ambient vibrations. In order for the highest fundamental period dominant mode of vibration to be excited by in-situ tests, relatively significant input levels of motion are required (i.e., the flexibility of the base and attachment needs to be exercised).

Many types of mechanical equipment components have fundamental periods below 0.06 sec and may be considered to be rigid. Examples include horizontal pumps, engine generators, motor generators, air compressors, and motor driven centrifugal blowers. Other types of mechanical equipment also are very stiff but may have fundamental periods up to approximately 0.125 sec. Examples of these mechanical equipment items include vertical immersion and deep well pumps, belt driven and vane axial fans, heaters, air handlers, chillers, boilers, heat exchangers, filters, and evaporators. These fundamental period estimates do not apply when the equipment is on vibration-isolator supports.

Electrical equipment cabinets can have fundamental periods of approximately 0.06 to 0.3 sec depending upon weight, stiffness of the enclosure assembly, flexibility of the enclosure base, and load path through to the attachment points. Tall and narrow motor control centers and switchboards lie in the upper end of this period range. Low and medium-voltage switchgear, transformers, battery chargers, inverters, instrumentation cabinets, and instrumentation racks usually have fundamental periods ranging from 0.1 to 0.2 sec. Braced battery racks, stiffened vertical control panels, benchboards, electrical cabinets with top bracing, and wall-mounted panelboards have fundamental periods ranging from 0.06 to 0.1 sec.

**6.3.4 MECHANICAL AND ELECTRICAL COMPONENT ATTACHMENTS:** For some items such as piping, relative seismic displacements between support points generally are of more significance than inertial forces. Components made of ductile materials such as steel or copper can accommodate relative displacement effects by inelastically conforming to the supports' conditions. However, components made of less ductile materials can only accommodate relative displacement effects by providing flexibility or flexible connections.

Of most concern are distribution systems that are a significant life-safety hazard and are routed between two separate building structures. Ductile components with bends and elbows at the building separation point or components that will be subject to bending stresses rather than direct tensile loads

due to differential support motion, are not so prone to damage and are not so likely to fracture and fall. This is valid if the supports can accommodate the imposed loads.

**6.3.5 COMPONENT SUPPORTS:** It is the intent of these requirements to ensure that all mechanical and electrical component supports, the means by which a component transfers seismic loads to the structure, be designed to accommodate the force and displacement effects prescribed. Component supports are differentiated here from component attachments to emphasize that the supports themselves, the structural members, braces, frames, skirts, legs, saddles, pedestals, cables, guys, stays, snubbers, and tethers, even if fabricated with and/or by the mechanical or electrical component manufacturer, should be designed for seismic forces. This is regardless of whether the mechanical or electrical component itself is designed for seismic loads. The intention is to prevent a component from sliding, falling, toppling, or otherwise moving such that the component would imperil life.

**6.3.6 COMPONENT CERTIFICATION:** It is intended that the certificate only be requested for components with an importance factor ( $I_p$ ) greater than 1.00 and only if the component has a doubtful or uncertain seismic load path. This certificate should not be requested to validate functionality concerns.

In the context of the *Provisions*, seismic adequacy of the component is of concern only when the component is required to remain operational after an earthquake or contains material that can pose a significant hazard if released. Meeting the requirements of this section shall be considered as an acceptable demonstration of the seismic adequacy of a component.

**6.3.7 UTILITY AND SERVICE LINES AT STRUCTURE INTERFACES:** For essential facilities, auxiliary on-site mechanical and electrical utility sources are recommended. It is recommended that an appropriate clause be included if existing codes for the jurisdiction do not presently provide for it.

Sec. 6.3.7 requires that adequate flexibility be provided for utilities at the interface of adjacent and independent structures to accommodate anticipated differential displacement. It affects architectural and mechanical/electrical fittings only where water and energy lines pass through the interface. The displacements considered must include the  $C_d$  factor of Sec. 5.2.2 and should be in accordance with *Provisions* Sec. 6.1.4.

Consideration may be necessary for nonessential piping carrying quantities of materials that could, if the piping is ruptured, damage essential utilities.

Following a review of information from the Northridge and Loma Prieta earthquakes and discussions with gas company personnel, automatic earthquake shutoff of gas lines at structure entry points is no longer required. The primary justification for this is the consensus opinion that shutoff devices tend to cause more problems than they solve. Commercially available shutoff devices tend to be susceptible to inadvertent shutoff caused by passing vehicles and other non-seismic vibrations. This leads to disruption of service and often requires that local gas companies reset the device and relight any pilot lights. In an earthquake, the majority of shutoff devices which actuate will be attached to undamaged gas lines. This results in a huge relight effort for the local utility at a time when resources are typically at a premium. If the earthquake occurs during the winter, a greater life hazard may exist from a lack of



gas supply than from potential gas leaks. In the future, as shutoff devices improve and gas-fired appliances which use pilots are phased out, it may be justified to require shutoff devices.

This is not meant to discourage individuals and companies from installing shutoff devices. In particular, individuals and companies who are capable of relighting gas fired equipment should seriously consider installation of these devices. In addition, gas valves should be closed whenever leaks are detected.

**6.3.9 STORAGE TANKS:** Storage tanks are considered nonbuilding structures and are covered in *Provisions* Chapter 14. See *Commentary* Sec. 14.4.3.

**6.3.10 HVAC DUCTWORK:** Experience in past earthquakes has shown that, in general, HVAC duct systems are rugged and perform well in strong shaking motions. Bracing in accordance with the Sheet Metal and Air Conditioning Contractors National Association (SMACNA) Ref. 6-17, 6-18, and 6-19 has been shown to be effective in limiting damage to duct systems under earthquake loads. Typical failures have affected system function only and major damage or collapse has been uncommon. Therefore, industry standard practices should prove adequate for most installations. Expected earthquake damage should be limited to opening of the duct joints and tears in the ducts. Connection details that are prone to brittle failures, especially hanger rods subject to large amplitude bending stress cycles, should be avoided.

Some ductwork systems carry hazardous materials or must remain operational during and after an earthquake. These ductwork systems would be designated as having an  $I_p$  greater than 1.0. A detailed engineering analysis for these systems should be performed.

All equipment (e.g., fans, humidifiers, and heat exchangers) attached to the ducts and weighing more than 75 lb (334 N) should be braced independently of the duct. Unbraced in-line equipment can damage the duct by swinging and impacting it during an earthquake. Items (e.g., dampers, louvers, and air diffusers) attached to the duct should be positively supported by mechanical fasteners (not friction-type connections) to prevent their falling during an earthquake.

Where it is desirable to limit the deflection of duct systems under seismic load, bracing in accordance with the SMACNA references listed in Sec. 6.1.1 may be used.

**6.3.11 PIPING SYSTEMS:** Experience in past earthquakes has shown that, in general, piping systems are rugged and perform well in strong shaking motions. Numerous standards and guidelines have been developed covering a wide variety of piping systems and materials. Construction in accordance with current requirements of the referenced national standards have been shown to be effective in limiting damage to and avoiding loss of fluid containment in piping systems under earthquake conditions. It is therefore the intention of the *Provisions* that nationally recognized standards be used to design piping systems provided that the force and displacement demand is equal to or exceeds the requirements of Sec. 6.1.3 and 6.1.4 and provisions are made to mitigate seismic interaction issues not normally addressed in the national standards.

The following industry standards, while not adopted by ANSI, are in common use and may be appropriate reference documents for use in the seismic design of piping systems.

SMACNA                      *Guidelines for the Seismic Restraint of Mechanical Systems*

ASHRAE CH 50-95 *Seismic Restraint Design*

Piping, as used herein, are assemblies of pipe, tubing, valves, fittings, and other in-line fluid containing components, excluding their attachments and supports.

**6.3.12 BOILERS AND PRESSURE VESSELS:** Experience in past earthquakes has shown that, in general, boilers and pressure vessels are rugged and perform well in strong shaking motions. Construction in accordance with current requirements of the *ASME Boiler and Pressure Vessel Code* (Ref. 6-2) has been shown to be effective in limiting damage to and avoiding loss of fluid containment in boilers and pressure vessels under earthquake conditions. It is therefore the intention of the *Provisions* that nationally recognized codes be used to design boilers and pressure vessels provided that the seismic force and displacement demand is equal to or exceeds the requirements of Sec. 6.1.3 and 6.1.4. Until such nationally recognized codes incorporate force and displacement requirements comparable to the requirements of Sec. 6.1.3 and 6.1.4, it is nonetheless the intention to use the design acceptance criteria and construction practices of those codes.

Boilers and pressure vessels as used herein are fired or unfired containments, including their internal and external appurtenances and internal assemblies of pipe, tubing, and fittings, and other fluid containing components, excluding their attachments and supports.

**6.3.13 MECHANICAL EQUIPMENT ATTACHMENTS AND SUPPORTS:** Past earthquakes have demonstrated that most mechanical equipment is inherently rugged and performs well provided that it is properly attached to the structure. This is because the design of mechanical equipment items for operational and transportation loads typically envelopes loads due to earthquake. For this reason, the requirements primarily focus on equipment anchorage and attachments. It was felt, however, that mechanical equipment components required to maintain containment of flammable or hazardous materials should themselves be designed for seismic forces.

In addition, the reliability of equipment operability after an earthquake can be increased if the following items are also considered in design:

- a. Internal assemblies are attached with a sufficiency that eliminates the potential of impact with other internal assemblies and the equipment wall; and
- b. Operators, motors, generators, and other such components functionally attached mechanical equipment by means of an operating shaft or mechanism are structurally connected or commonly supported with sufficient rigidity such that binding of the operating shaft will be avoided.

**6.3.14 ELECTRICAL EQUIPMENT ATTACHMENTS AND SUPPORTS:** Past earthquakes have demonstrated that most electrical equipment is inherently rugged and performs well provided that it is properly attached to the structure. This is because the design of electrical equipment items for operational and transportation loads typically envelopes loads due to earthquake. For this reason, the requirements primarily focus on equipment anchorage and attachments. However, reliability of equipment operability after an earthquake can be increased if the following items also are considered in design:

- a. Internal assemblies are attached with a sufficiency that electrical subassemblies and contacts will not be subject to differential movement or impact between the assemblies, contacts, and the equipment enclosure.

- b. Any ceramic or other nonductile components in the seismic load path should be specifically evaluated.
- c. Adjacent electrical cabinets are bolted together and cabinet lineups are prevented from banging into adjacent structural members.

**6.3.15 ALTERNATE SEISMIC QUALIFICATION METHODS:** Testing is a well established alternative method of seismic qualification for small to medium size equipment. Several national standards, other than IEEE 344 (Ref. 6-12), have testing requirements adaptable for seismic qualification.

**6.3.16 ELEVATOR DESIGN REQUIREMENTS:** The ASME *Safety Code for Elevators and Escalators* (Ref. 6-1) has adopted many requirements to improve the seismic response of elevators; however, they do not apply to some regions covered by this chapter. These changes are to extend force requirements for elevators to be consistent with the *Provisions*.

**6.3.16.2 Elevator Machinery and Controller Supports and Attachments:** The ASME *Safety Code for Elevators and Escalators* (Ref. 6-1) has no seismic requirements for supports and attachments for some structures and zones where the *Provisions* are applicable. Criteria are provided to extend force requirements for elevators to be consistent with the intent and scope of the *Provisions*.

**6.3.16.3 Seismic Controls:** The purpose of the seismic switch as used here is different from that provided under the ASME *Safety Code for Elevators and Escalators* (Ref. 6-3), which has incorporated several requirements to improve the seismic response of elevators (e.g., rope snag point guard, rope retainer guards, guide rail brackets) that do not apply to some buildings and zones covered by the *Provisions*. Building motions that are expected in these uncovered seismic zones are sufficiently large to impair the operation of elevators. The seismic switch is positioned high in the structure where structural response will be the most severe. The seismic switch trigger level is set to shut down the elevator when structural motions are expected to impair elevator operations.

Elevators in which the seismic switch and counterweight derail device have triggered should not be put back into service without a complete inspection. However, in the case where the loss of use of the elevator creates a life-safety hazard, an attempt to put the elevator back into service may be attempted. Operating the elevator prior to inspection may cause severe damage to the elevator or its components.

The building owner should have detailed written procedures in place directing the elevator operator/maintenance personnel which elevators in the facility are necessary from a post-earthquake life safety perspective. It is highly recommended that these procedures be in-place, with appropriate personnel training prior to an event strong enough to trip the seismic switch.

Once the elevator seismic switch is reset, it will respond to any call at any floor. It is important that the detailed procedure include the posting of "out-of-service for testing" signs at each door at each floor, prior to resetting the switch. Once the testing is completed, and the elevator operator/maintenance personnel are satisfied that the elevator is safe to operate, the signs can be removed.

**6.3.16.4 Retainer Plates:** The use of retainer plates is a very low cost provision to improve the seismic response of elevators.

## RELATED CONCERNS:

**Maintenance:** Mechanical and electrical devices installed to satisfy the requirements of the *Provisions* (e.g., resilient mounting components or certain protecting devices) require maintenance to ensure their reliability and provide the protection in case of a seismic event for which they are designed.

Specifically, rubber-in-shear mounts or spring mounts (if exposed to weathering) may deteriorate with time and, thus, periodic testing is required to ensure that their damping action will be available during an earthquake. Pneumatic mounting devices and electric switchgear must be maintained free of dirt and corrosion. How a regulatory agency could administer such periodic inspections was not determined and, hence, requirements to cover this situation have not been included.

**Tenant Improvements:** It is intended that the requirements in Chapter 6 also apply to newly constructed tenant improvements that are listed in Tables 6.2.2 and 6.3.2 and that are installed at any time during the life of the structure.

**Minimum Standards:** Criteria represented in the *Provisions* represent minimum standards. They are designed to minimize hazard for occupants and to improve the likelihood of functioning of facilities required by the community to deal with the consequences of a disaster. They are not designed to protect the owner's investment, and the designer of the facility should review with the owner the possibility of exceeding these minimum standards so as to limit his economic risk.

The risk is particularly acute in the case of sealed, air-conditioned structures where downtime after a disaster can be materially affected by the availability of parts and labor. The parts availability may be significantly worse than normal because of a sudden increase in demand. Skilled labor also may be in short demand since available labor forces may be diverted to high priority structures requiring repairs.

**Architect-Engineer Design Integration:** The subject of architect-engineer design integration is being raised because it is believed that all members of the profession should clearly understand that Chapter 6 is a compromise based on concerns for enforcement and the need to develop a simple, straightforward approach. It is imperative that from the outset architectural input concerning definition of occupancy classification and the required level of seismic resistance be properly integrated with the approach of the structural engineer to seismic safety if the design profession as a whole is to make any meaningful impact on the public conscience in this issue. Accordingly, considerable effort was spent in this area of concern. It is hoped that as the design profession gains more knowledge and sophistication in the use of seismic design, it will collectively be able to develop a more comprehensive approach to earthquake design requirements.

## REFERENCES

ANCO Engineers, Inc. 1983. *Seismic Hazard Assessment of Non-Structural Components -- Phase I*, Final Report for National Science Foundation from ANCO Engineers, Inc., Culver City, California, September.

Bachman, R. E, and R. M. Drake. 1996. A Study To Empirically Validate the Component Response Modification Factors in the 1994 *NEHRP Provisions* Design Force Equations for Architectural, Mechanical, and Electrical Components, letter report to the National Center for Earthquake Engineering Research, July.

Bachman, R. E., R. M. Drake, and P. J. Richter. 1993. *1994 Update to 1991 NEHRP Provisions for Architectural, Mechanical, and Electrical Components and Systems*, letter report to the National Center for Earthquake Engineering Research, February 22.

Drake, R. M., and R. E. Bachman. 1996. "NEHRP Provisions for 1994 for Nonstructural Components," *ASCE Journal of Architectural Engineering*, March.

Drake, R. M., and R. E. Bachman. 1995. "Interpretation of Instrumented Building Seismic Data and Implications for Building Codes," in *Proceedings of the 1995 SEAoC Annual Convention*.

Drake, R. M., and R. E. Bachman. 1994. "1994 NEHRP Provisions for Architectural Mechanical, and Electrical Components," in *Proceedings, 5th United States National Conference on Earthquake Engineering*.

Housner, G. W., and M. A. Haroun. 1980. "Seismic Design of Liquid Storage Tanks" in *ASCE Convention Proceedings*.

## Chapter 7 Commentary

### FOUNDATION DESIGN REQUIREMENTS

**7.1 GENERAL:** The minimum foundation design requirements that might be suitable when any consideration must be given to earthquake resistance are set forth in Chapter 7. It is difficult to separate foundation requirements for minimal earthquake resistance from the requirements for resisting normal vertical loads. In order to have a minimum base from which to start, this chapter assumes compliance with all basic requirements necessary to provide support for vertical loads and lateral loads other than earthquake. These basic requirements include, but are not limited to, provisions for the extent of investigation needed to establish criteria for fills, slope stability, expansive soils, allowable soil pressures, footings for specialized construction, drainage, settlement control, and pile requirements and capacities. Certain detail requirements and the allowable stresses to be used are provided in other chapters of the *Provisions* as are the additional requirements to be used in more seismically active locations.

**7.2 STRENGTH OF COMPONENTS AND FOUNDATIONS:** The resisting capacities of the foundations must meet the provisions of Chapter 7.

**7.2.1 Structural Materials:** The strength of foundation components subjected to seismic forces alone or in combination with other prescribed loads and their detailing requirements must be as determined in Chapters 8, 9, 10, 11, or 12.

**7.2.2 Soil Capacities:** This section requires that the building foundation without seismic forces applied must be adequate to support the building gravity load. When seismic effects are considered, the soil capacities can be increased considering the short time of loading and the dynamic properties of the soil.

**7.3 SEISMIC DESIGN CATEGORIES A AND B:** There are no special seismic provisions for the design of foundations for buildings assigned to Categories A and B.

**7.4 SEISMIC DESIGN CATEGORY C:** Extra precautions are required for the seismic design of foundations for buildings assigned to Category C.

**7.4.1 Investigation:** Potential site hazards such as fault rupture, liquefaction, ground deformation, and slope instability should be investigated when the size and importance of the project so warrants. In this section, procedures for evaluating these hazards are reviewed.

*Surface Fault Rupture:* Fault ruptures during past earthquakes have led to large surface displacements that are potentially destructive to engineered construction. Displacements, which range from a fraction of an inch to tens of feet, generally occur along traces of previously active faults. The sense of displacement ranges from horizontal strike-slip to vertical dip-slip to many combinations of these components. The following commentary summarizes procedures to follow or consider when assessing the hazard of surface fault rupture. This commentary is based in large

part on Appendix C of California Division of Mines and Geology (CDMG) Special Publication 42, 1988 Revision (Hart, 1988).

*Assessment of Surface Faulting Hazard:* The evaluation of fault hazard at a given site is based extensively on the concepts of recency and recurrence of faulting along existing faults. The magnitude, sense, and frequency of fault rupture vary for different faults or even along different segments of the same fault. Even so, future faulting generally is expected to recur along pre-existing faults. The development of a new fault or reactivation of a long inactive fault is relatively uncommon and generally need not be a concern. For most engineering applications, a sufficient definition of an active fault is given in CDMG Special Publication 42 (Hart, 1988): "An active fault has had displacement in Holocene time (last 11,000 years)."

As a practical matter, fault investigations should be conducted by qualified geologists and directed at the problem of locating faults and evaluating recency of activity, fault length, and the amount and character of past displacements. Identification and characterization studies should incorporate evaluation of regional fault patterns as well as detailed study of fault features at and in the near vicinity (within a few hundred yards to a mile) of the site. Detailed studies should include trenching to accurately locate, document, and date fault features.

*Suggested Approach for Assessing Surface Faulting Hazard:* The following approach should be used, or at least considered, in fault hazard assessment. Some of the investigative methods outlined below should be carried out beyond the site being investigated. However, it is not expected that all of the following methods would be used in a single investigation:

1. A review should be made of the published and unpublished geologic literature from the region along with records concerning geologic units, faults, ground-water barriers, etc.
2. A stereoscopic study of aerial photographs and other remotely sensed images should be made to detect fault-related topography, vegetation and soil contrasts, and other lineaments of possible fault origin. Predevelopment air photos are essential to the detection of fault features.
3. A field reconnaissance study generally is required which includes observation and mapping of geologic and soil units and structures, geomorphic features, springs, and deformation of man-made structures due to fault creep. This study should be detailed within the site with less detailed reconnaissance of an area within a mile or so of the site.
4. Subsurface investigations usually are needed to evaluate fault features. These investigations include trenches, pits, or bore holes to permit detailed and direct observation of geologic units and fault features.
5. The geometry of fault structures may be further defined by geophysical investigations including seismic refraction, seismic reflection, gravity, magnetic intensity, resistivity, ground penetrating radar, etc. These indirect methods require a knowledge of specific geologic conditions for reliable interpretation. Geophysical methods alone never prove the absence of a fault and they do not identify the recency of activity.
6. More sophisticated and more costly studies may provide valuable data where geological special conditions exist or where requirements for critical structures demand a more intensive

investigation. These methods might involve repeated geodetic surveys, strain measurements, or monitoring of microseismicity and radiometric analysis ( $^{14}\text{C}$ , K-Ar), stratigraphic correlation (fossils, mineralogy) soil profile development, paleomagnetism (magnetostratigraphy), or other age-dating techniques to date the age of faulted or unfaulted units or surfaces.

The following information should be developed to provide documented support for conclusions relative to location and magnitude of faulting hazards:

1. Maps should be prepared showing the existence (or absence) and location of hazardous faults on or near the site.
2. The type, amount, and sense of displacement of past surface faulting episodes should be documented including sense and magnitude of displacement, if possible.
3. From this documentation, estimates can be made, preferably from measurements of past surface faulting events at the site, using the premise that the general pattern of past activity will repeat in the future. Estimates also may be made from empirical correlations between fault displacement and fault length or earthquake magnitude published by Bonilla et al. (1984) or by Slemmons et al. (1989). Where fault segment length and sense of displacement are defined, these correlations may provide an estimate of future fault displacement (either the maximum or the average to be expected).

There are no codified procedures for estimating the amount or probability of future fault displacements. Estimates may be made, however, by qualified earth scientists. Because techniques for making these estimates are not standardized, peer review of reports is useful to verify the adequacy of the methods used and the estimates reports, to aid the evaluation by the permitting agency, and to facilitate discussion between specialists that could lead to the development of standards.

The following guidelines are given for safe siting of engineered construction in areas crossed by active faults:

1. Where ordinances have been developed that specify safe setback distances from traces of active faults or active fault zones, those distances must be complied with and accepted as the minimum for safe siting of buildings. For example, the general setback requirement in California is a minimum of 50 feet from a well-defined zone containing the traces of an active fault. That setback distance is mandated as a minimum for structures near faults unless a site-specific special geologic investigation shows that a lesser distance could be safely applied (*California Administrative Code*, Title 14, Sec. 3603A).
2. In general, safe setback distances may be determined from geologic studies and analyses as noted above. Setback requirements for a site should be developed by the site engineers and geologists in consultation with professionals from the building and planning departments of the jurisdiction involved. Where sufficient geologic data have been developed to accurately locate the zone containing active fault traces and the zone is not complex, a 50-foot setback distance may be specified. For complex fault zones, greater setback distances may be required. Dip-slip faults, with either normal or reverse motion, typically produce multiple fractures within rather wide and irregular fault zones. These zones generally are confined to the hanging-wall side of the fault leaving the footwall side little disturbed. Setback require-



ments for such faults may be rather narrow on the footwall side, depending on the quality of the data available, and larger on the hanging wall side of the zone. Some fault zones may contain broad deformational features such as pressure ridges and sags rather than clearly defined fault scarps or shear zones. Nonessential structures may be sited in these zones provided structural mitigative measures are applied as noted below. Studies by qualified geologists and engineers are required for such zones to assure that building foundations can withstand probable ground deformations in such zones.

*Mitigation of Surface Faulting Hazards:* There is no mitigative technology that can be used to prevent fault rupture from occurring. Thus, sites with unacceptable faulting hazard must either be avoided or structures designed to withstand ground deformation or surface fault rupture. In general practice, it is economically impractical to design a structure to withstand more than a few inches of fault displacement. Some buildings with strong foundations, however, have successfully withstood or diverted a few inches of surface fault rupture without damage to the structure (Youd, 1989). Well reinforced mat foundations and strongly inter-tied footings have been most effective. In general, less damage has been inflicted by compressional or shear displacement than by vertical or extensional displacements.

*Liquefaction:* Liquefaction of saturated granular soils has been a major source of building damage during past earthquakes. For example, many structures in Niigata, Japan, suffered major damage as a consequence of liquefaction during the 1964 earthquake. Loss of bearing strength, differential settlement, and differential horizontal displacement due to lateral spread were the direct causes of damage. Many structures have been similarly damaged by differential ground displacements during U.S. earthquakes such as the San Fernando Valley Juvenile Hall during the 1971 San Fernando, California, earthquake and the Marine Sciences Laboratory at Moss Landing, California, during the 1989 Loma Prieta event. Design to prevent damage due to liquefaction consists of three parts: evaluation of liquefaction hazard, evaluation of potential ground displacement, and mitigating the hazard by designing to resist ground displacement, by reducing the potential for liquefaction, or by choosing an alternative site with less hazard.

*Evaluation of Liquefaction Hazard:* Liquefaction hazard at a site is commonly expressed in terms of a factor of safety. This factor is defined as the ratio between the available liquefaction resistance, expressed in terms of the cyclic stresses required to cause liquefaction, and the cyclic stresses generated by the design earthquake. Both of these stress parameters are commonly normalized with respect to the effective overburden stress at the depth in question.

The following possible methods for calculating the factor of safety against liquefaction have been proposed and used to various extents:

1. Analytical Methods -- These methods typically rely on laboratory test results to determine either liquefaction resistance or soil properties that can be used to predict the development of liquefaction. Various equivalent linear and nonlinear computer methods are used with the laboratory data to evaluate the potential for liquefaction. Because of the considerable difficulty in obtaining undisturbed samples of liquefiable sediment for laboratory evaluation of constitutive soil properties, the use of analytical methods, which rely on accurate constitutive properties, usually are limited to critical projects or to research.

2. Physical Modeling -- These methods typically involve the use of centrifuges or shaking tables to simulate seismic loading under well defined boundary conditions. Soil used in the model is reconstituted to represent different density and geometrical conditions. Because of difficulties in precisely modeling in-situ conditions at liquefiable sites, physical models have seldom been used in design studies for specific sites. However, physical models are valuable for analyzing and understanding generalized soil behavior and for evaluating the validity of constitutive models under well defined boundary conditions.
3. Empirical Procedures -- Because of the difficulties in analytically or physically modeling soil conditions at liquefiable sites, empirical methods have become a standard procedure for determining liquefaction susceptibility in engineering practice. Procedures for carrying out a liquefaction assessment using the empirical method are given by the National Research Council (1985).

For most empirical methods, the average earthquake-induced cyclic shear stress is estimated from a simple equation or from dynamic response analyses using computer programs such as SHAKE and DESRA. The induced cyclic shear stress is estimated from the peak horizontal acceleration expected at the site using the following simple equation:

$$\frac{\tau}{\sigma'_o} = 0.65 \left( \frac{a_{max}}{g} \right) \left( \frac{\sigma_o}{\sigma'_o} \right) r_d \quad (C7.4.1-1)$$

where  $(a_{max}/g)$  = peak horizontal acceleration at ground surface expressed as a decimal fraction of gravity,  $\sigma_o$  = the vertical total stress in the soil at the depth in question,  $\sigma'_o$  = the vertical effective stress at the same depth, and  $r_d$  = deformation-related stress reduction factor.

The chart reproduced in Figure C7.4.1-1 is used to estimate  $r_d$ .

To determine liquefaction resistance of sandy soils, the induced cyclic stress ratio computed from Eq. C7.4.1-1 is compared to the cyclic stress ratio required to generate liquefaction in the soil in question for a given earthquake of magnitude  $M$ . The most common technique for estimating liquefaction resistance is from an empirical relationship between cyclic stress ratio required to cause liquefaction and normalized blow count,  $(N_1)_{60}$ .

The most commonly used empirical relationship, compiled by Seed et al. (1985),

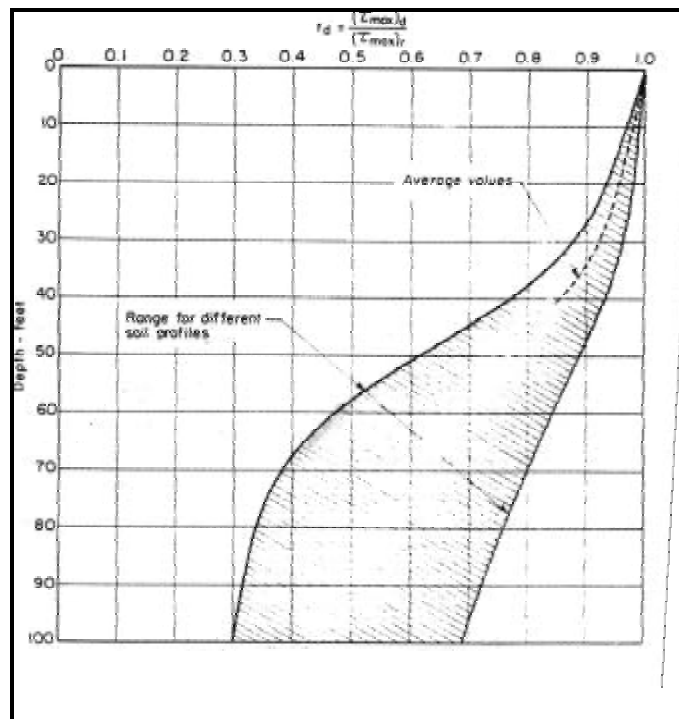

FIGURE C7.4.1-1 Range of values for  $r_d$  for different soil properties (after Seed and Idriss, 1971).

compares  $(N_1)_{60}$  from sites where liquefaction did or did not develop during past earthquakes. Figure C7.4.1-2 shows the most recent (1988) version of this relationship for  $M = 7-1/2$  earthquakes. On that figure, cyclic stress ratios calculated for various sites are plotted against  $(N_1)_{60}$ . Solid dots represent sites where liquefaction occurred and open dots represent sites where surface evidence of liquefaction was not found. Curves were drawn through the data to separate regions where liquefaction did and did not develop. Curves are given for sediments with various fines contents.

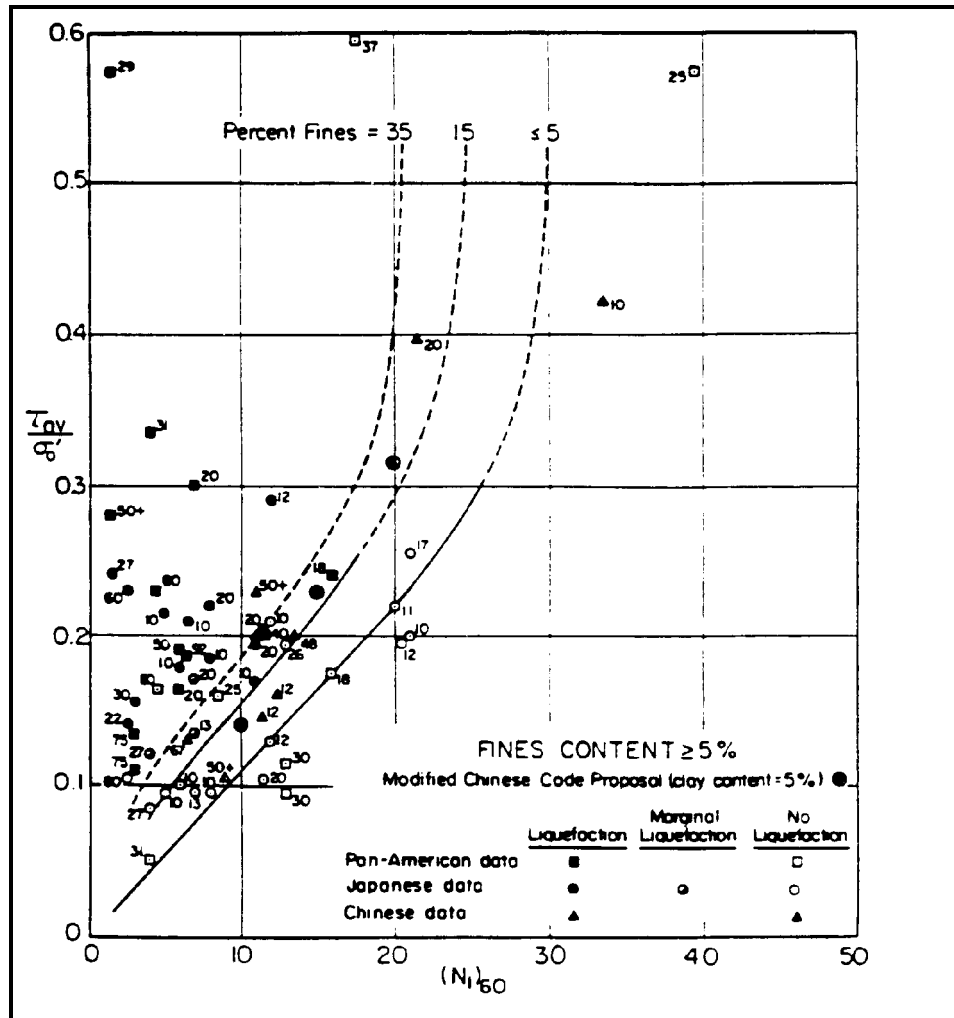

FIGURE C7.4.1-2 Relationship between stress ratios causing liquefaction and  $N_1$  values for silty sands for  $M = 7-1/2$  earthquakes.

Although the curves drawn by Seed et al. (1985) envelop the plotted data, it is possible that liquefaction may have occurred beyond the enveloped data and was not detected at ground surface. Consequently, a factor of safety of 1.2 to 1.5 is appropriate in engineering design. The factor to be used is based on engineering judgment with appropriate consideration given to type and importance of structure and potential for ground deformation.

The maximum acceleration,  $a_{max}$ , commonly used in liquefaction analysis is that which would occur at the site in the absence of liquefaction. Thus, the  $a_{max}$  used in Eq. C7.4.1-1 is the estimated rock acceleration corrected for soil site response but with neglect of excess pore-water pressures that might develop. Alternatives for obtaining  $a_{max}$  are: (1) from standard peak acceleration attenuation curves valid for comparable soil conditions; (2) from standard peak acceleration attenuation curves for rock, corrected for site amplification or deamplification by means of standard amplification curves or computerized site response analysis such as described in the "Chapter 1 Commentary" for Sec. 1.4.2; (3) obtaining first the value of effective peak acceleration,  $A_a$ , for rock depending on the map area where the site is located and then multiplying this value by a factor between 1 and 3 as discussed in the "Chapter 1 Commentary" for Sec. 1.4.2 to determine  $a_{max}$ ; (4) from probabilistic maps of  $a_{max}$  with or without correction for site amplification or deamplification depending on the rock or soil conditions used to generate the map.

The magnitude,  $M$ , needed to determine a magnitude scaling factor from Figure C7.4.1-3 should correspond to the size of the design or expected earthquake selected for the liquefaction evaluation. If Alternative 3 or 4 is selected, the definition of  $M$  is not obvious and additional studies and considerations are necessary. In all cases, it should be remembered that the likelihood of liquefaction at the site (as defined later by the factor of safety  $F_L$  in Eq. C7.4.1-3) is determined **jointly** by  $a_{max}$  and  $M$ . Because of the longer duration of strong ground-shaking, large distant earthquakes may generate liquefaction at a site while smaller nearby earthquakes may not generate liquefaction even though  $a_{max}$  of the nearer events is larger than that from the more distant events.

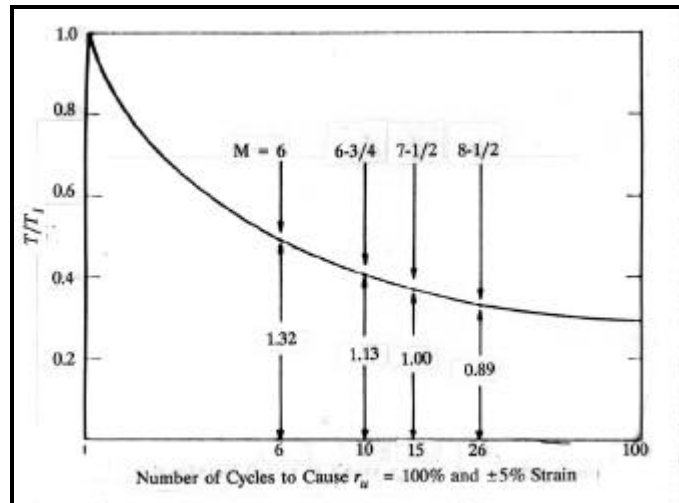

FIGURE C7.4.1-3 Representative relationship between  $T/T_1$  and number of cycles required to cause liquefaction (after Seed et al., 1983).

The corrected blow count,  $(N_1)_{60}$ , required for evaluation of soil liquefaction resistance is commonly determined from measured standard penetration resistance,  $N_m$ , but may also be determined from cone penetration test (CPT) data using standard correlations to estimate  $N_m$  values from the CPT measurements. The corrected blow count is calculated from  $N_m$  as follows:

$$(N_1)_{60} = C_n \left( \frac{ER_m}{60} \right) N_m \quad (C7.4.1-2)$$

where  $C_n$  = a factor that corrects  $N_m$  to an effective overburden pressure of 1 tsf and  $ER_m$  = the rod energy ratio for the type of hammer and release mechanism used in the measurement of  $N_m$ .

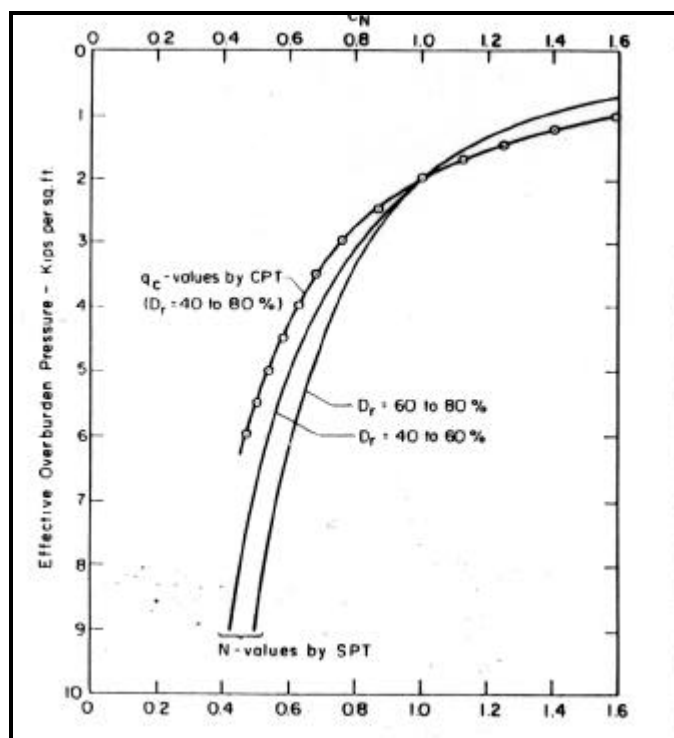

FIGURE C7.4.1-4 Chart for  $C_n$  (after Seed et al., 1985).

The curve plotted in Figure C7.4.1-4 is typically used to evaluate  $C_n$ . Measured hammer energies or estimates of hammer energies from tabulations such as those in Table C7.4.1 are used to define  $ER_m$ . An additional correction should be made to  $(N_1)_{60}$  for shallow soil layers where the length of drilling rod is 10 feet or less. In those instances,  $(N_1)_{60}$  should be reduced by multiplying by a factor of 0.75 to account for poor hammer-energy transfer in such short rod lengths.

Because a variety of equipment and procedures are used to conduct standard penetration tests in present practice and because the measured blow count,  $N_m$ , is sensitive to the equipment and procedures used, the following commentary and guidance with respect to this test is given. Special attention must be paid to the determination of normalized blow count,

$(N_1)_{60}$ , used in Figure C7.4.1-2. When developing the empirical relation between blow count and liquefaction resistance, Seed and his colleagues recognized that the blow count from SPT is greatly influenced by factors such as the method of drilling, the type of hammer, the sampler design, and the type of mechanism used for lifting and dropping the hammer. The magnitude of variations is shown by the data in Table C7.4.1.

TABLE C7.4.1 Summary of Rod Energy Ratios for Japanese SPT Procedures (after Seed et al., 1985)

Study	Mechanical Trip System (Tonbi)	Rope and Pulley
Nishizawa et al.	80-90	63-72
Decker, Holtz, and Kovacs	76	--
Kovacs and Salomone	80	67
Tokimatsu and Yoshimi	76 <sup>a</sup>	--
Yoshimi and Tokimatsu, Yoshimi et al., Oh-Oka	--	--
Adopted for this study	78	67

<sup>a</sup> Equivalent rod energy ratio if rope and pulley method is assumed to have an energy ratio of 67 percent and values for mechanical trip method are different from this by a factor of 1.13.

In order to reduce variability in the measurement of  $N$ , Seed et al. (1983 and 1985) suggest the following procedures and specifications for the SPT test for liquefaction investigations:

1. The impact should be delivered by a rope and drum system with two turns of the rope around the rotating drum to lift a hammer weighing 140 lb or, more preferably, a drive system should be used for which  $ER_m$  has been measured or can be reliably estimated.
2. Use of a hole drilled with rotary equipment and filled with drilling mud. The hole should be approximately 4 in. in diameter and drilled with a tricone or baffled drag bit that produces upward deflection of the drilling fluid to prevent erosion of soil below the cutting edge of the bit.
3. In holes less than 50 feet deep, A or AW rod should be used; N or NW rod should be used in deeper holes.
4. The split spoon sampling tube should be equipped with liners or otherwise have a constant internal diameter of 1-3/8 inch.
5. Application of blows should be at a rate of 30 to 40 blows per minutes. (Some engineers suggest a slower rate of 20 to 30 blows per minute since it is easier to achieve and control and gives comparable results.) The blow count,  $N_m$ , is determined by counting the blows required to drive the penetrometer through the depth interval of 6 to 18 in. below the bottom of the hole.

Failure to follow these standard guidelines introduces large uncertainties into liquefaction estimates.

The curves in Figure C7.4.1-2 were developed from data for magnitude 7.5 earthquakes and are only valid for earthquakes of that magnitude. For larger or smaller earthquakes, the cyclic stress ratios determined from Figure C7.4.1-2 are corrected for magnitude by multiplying the determined cyclic stress ratio by a magnitude scaling factor taken from Figure C7.4.1-3. As the magnitude increases, the scaling factor decreases. For example, for an  $(N_1)_{60}$  of 20, a clean sand (fines content < 5 percent) and an earthquake magnitude of 7.5, the CSRL determined from Figure C7.4.1-2 is 0.22. For the same site conditions but for a magnitude 8.0 earthquake, a CSRL of 0.20 is obtained after applying the magnitude scaling factor of 0.89 determined from Figure C7.4.1-3.

Soils composed of sands, silts, and gravels are most susceptible to liquefaction while clayey soils generally are immune to this phenomenon. The curves in Figure C7.4.1-2 are valid for soils composed primarily of sand. The curves should be used with caution for soils with substantial amounts of gravel. Verified corrections for gravel content have not been developed; a geotechnical engineer, experienced in liquefaction hazard evaluation, should be consulted when gravelly soils are encountered. For soils containing more than 35 percent fines, the curve in Figure C7.4.1-2 for 35 percent fines should be used provided the following criteria developed by Seed et al. (1983) are met (i.e, the weight of soil particles finer than 0.005 mm is less than 15 percent of the dry weight of a specimen of the soil, the liquid limit of soil is less than 35 percent, and the moisture content of the in-place soil is greater than 0.9 times the liquid limit.

In summary, the procedure for evaluation of liquefaction resistance for a site is as follows: First, from a site investigation determine the measured standard penetration resistance,  $N_m$ , the percent fines, the percent clay (> 0.005 mm), the natural moisture content, and the liquid limit of the sediment in question. Check the measured parameters against the fines content and moisture

criteria listed above to assure that the sediment is of a potentially liquefiable type. If so, correct  $N_m$  to  $(N_1)_{60}$  using Eq. C7.4.1-2 and use Figure C7.4.1-2 to determine the cyclic stress ratio required to cause liquefaction for a magnitude 7.5 earthquake. Then correct that value using the appropriate magnitude scaling factor. That product is the cyclic stress ratio required to cause liquefaction in the field (CSRL). Next, calculate the cyclic stress ratio (CSRE) that would be generated by the expected earthquake using Eq. C7.4.1-1. Then compute the factor of safety,  $F_L$ , against liquefaction from the equation:

$$F_L = \frac{CSRL}{CSRE} \quad (C7.4.1-3)$$

If  $F_L$  is greater than one, then liquefaction should not develop. If at any depth in the sediment profile,  $F_L$  is equal to or less than one, then there is a liquefaction hazard. As noted above, a factor of safety of 1.2 to 1.5 is appropriate for building sites with the factor selected depending on the importance of the structure and the potential for ground displacement at the site.

*Evaluation of Potential for Ground Displacements:* Liquefaction by itself may or may not be of engineering significance. Only when liquefaction is accompanied by loss of ground support and/or ground deformation does this phenomenon become important to structural design. Loss of bearing capacity, flow failure, lateral spread, ground oscillation, and ground settlement are ground failure mechanisms that have caused structural damage during past earthquakes. These types of ground failure are described by the National Research Council (1985). The type of failure and amount of ground displacement are a function of several parameters including the thickness and extent of the liquefied layer, the thickness of unliquefied material overlying the liquefied layer, the ground slope, and the nearness of a free face. Criteria are given by Ishihara (1985) for evaluating the influence of thickness of layers on surface manifestation of liquefaction effects (ground fissures and sand boils) for level sites. These criteria may be used for noncritical or nonessential structures on level sites. Additional analysis should be required for critical or essential structures.

*Loss of Bearing Strength:* Loss of bearing strength is not likely for light structures with shallow footings founded on stable, nonliquefiable materials overlying deeply buried liquefiable layers, particularly if the liquefiable layers are relatively thin. General guidance for how deep or how thin the layers must be has not yet been developed. A geotechnical engineer, experienced in liquefaction hazard assessment, should be consulted to provide such guidance. Although loss of bearing strength may not be a hazard for deeply buried liquefiable layers, liquefaction-induced ground settlements or lateral-spread displacements could still cause damage and should be evaluated.

*Ground Settlement:* Tokimatsu and Seed (1987) published an empirical procedure for estimating ground settlement. It is beyond the scope of this commentary to outline that procedure which, although explicit, has several rather complex steps. For saturated or dry granular soils in a loose condition, their analysis suggests that the amount of ground settlement could approach 3 to 4 percent of the thickness of the loose soil layer. The Tokimatsu and Seed technique is recommended for estimating earthquake-induced ground settlement at sites underlain by granular soils and can be applied whether liquefaction does or does not occur.

**Horizontal Ground Displacement:** Only primitive analytical and empirical techniques have been developed to date to estimate ground displacement, and no single technique has been widely accepted or verified for engineering design. Analytical techniques generally apply Newmark's analysis of a rigid body sliding on an infinite or circular failure surface with ultimate shear resistance estimated from the residual strength of the deforming soil. Alternatively, nonlinear finite element methods have been used to predict deformations. Empirical procedures use correlations between past ground displacement and site conditions under which those displacements occurred. The liquefaction severity index (LSI) correlation of Youd and Perkins (1987) provides a conservative upper bound for displacement for most natural soils (Figure C7.4.1-5; curves noted for various earthquakes are calculated from the equation on the figure). In this procedure, maximum horizontal displacement of lateral spreads in late Holocene fluvial deposits are correlated against earthquake magnitude and distance for the seismic source. The data are from the western United States and the correlation is valid only for that region. Because maximum displacements at very liquefiable sites were used in the LSI analysis, displacements predicted by that technique are conservative in that they predict an upper bound displacement for most natural deposits. Displacements may be greater, however, on uncompacted fill or extremely loose natural deposits.

The ground motions to be primarily considered in evaluating liquefaction potential are consistent with the *design earthquake* motions used in structural design. The structural design should be consistent with liquefaction-induced deformations resulting from those ground motions.

Liquefaction-induced deformations are not directly proportional to ground motions and may be more than 50 percent higher for maximum considered earthquake ground motions. The liquefaction potential and resulting deformations for ground motions consistent with the maximum considered earthquake should also be evaluated and, while not required in these *Provisions*, should be used by the registered design professional in checking for building damage that may result in collapse. In addition, Seismic Use Group III structures should be designed to retain a significant margin against collapse following liquefaction-induced deformations resulting from maximum considered earthquake ground motions.

The following further information is given for general guidance for ground conditions and range of displacements commonly associated with liquefaction-induced ground failures (National Research Council, 1995; Barlett and Youd, 1995):

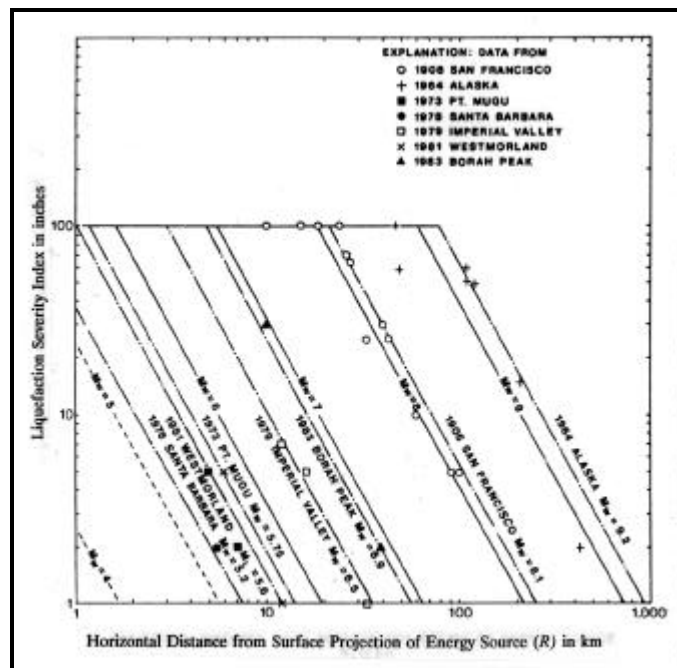

**FIGURE 7.4.1-5** LSI from several western U.S. and Alaskan earthquakes plotted against horizontal distance from seismic energy sources (after Youd and Perkins, 1987).



1. Flow failures generally develop in loose saturated sands or silts on slopes greater than 3 degrees (5 percent) and may displace large masses of soil tens of meters. Standard limit equilibrium slope stability analyses may be used to assess flow failure potential with the residual strength used as the strength parameter in the analyses. The residual strength may be determined from empirical correlations such as that published by Seed and Harder (1989).
2. Lateral spreads generally develop on gentle slopes between 0.5 and 3 degrees (0.1 and 5 percent) and may induce up to several feet of lateral displacement. Empirical correlations have been developed by Bartlett and Youd (1995) to estimate lateral ground displacement due to liquefaction. Analytical procedures using appropriately reduced (residual) strengths of soils also are available to estimate displacements. These procedures range from simplified Newmark-type sliding block methods (e.g., Newmark, 1985; Makdisi and Seed, 1978) to more sophisticated finite element analyses. In general, the empirical correlations are simple to apply, do not require data beyond the commonly compiled engineering site investigations, and are usually adequate for routine engineering applications.
3. Ground oscillation occurs on nearly flat surfaces where the slope is too gentle to induce permanent horizontal displacement. During an earthquake, however, ground oscillation generates transient vertical or horizontal displacements that may range up to a few feet. For example, ground oscillation caused the rather chaotic pattern of ground displacements that offset pavements, thrust sidewalks over curbs, etc., in San Francisco's Marina District following the 1989 Loma Prieta earthquake.

*Mitigation of Liquefaction Hazard:* With respect to liquefaction hazard, three mitigative measures might be considered: design the structure to resist the hazard, stabilize the site to reduce the hazard, or choose an alternative site. Structural measures that are used to reduce the hazard include deep foundations, mat foundations, or footings interconnected with ties as discussed in Sec. 7.4.3. Deep foundations have performed well at level sites of liquefaction where effects were limited to ground settlement and ground oscillation with no more than a few inches of lateral displacement. Deep foundations, such as piles, may receive very little soil support through the liquefied layer and may be subjected to transient lateral displacements across the layer. Well reinforced mat foundations also have performed well at localities where ground displacements were less than 1 foot although releveling of the structure has been required in some instances (Youd, 1989). Strong ties between footings also should provide increased resistance to damage where differential ground displacements are less than a few inches.

Evaluations of structural performance following two recent Japanese earthquakes, 1993 Hokkaido Nansei-Oki ( $M = 8.2$ ) and 1995 (Kobe) Hyogo-Ken Nanbu ( $M = 7.2$ ), indicate that small *structures* on shallow foundations performed well in liquefaction areas. Sand boil eruptions and open ground fissures in these areas indicate minor effects of liquefaction, including ground oscillation and up to several tenths of a meter of lateral spread displacement. Many small *structures* (mostly houses, shops, schools, etc.) were structurally undamaged although a few tilted slightly. Foundations for these *structures* consist of reinforced concrete perimeter wall footings with reinforced concrete interior wall footings tied into the perimeter walls at intersections. These foundations acted as diaphragms causing the soil to yield beneath the foundation which prevented fracture of foundations and propagation of differential displacements into the superstructure.

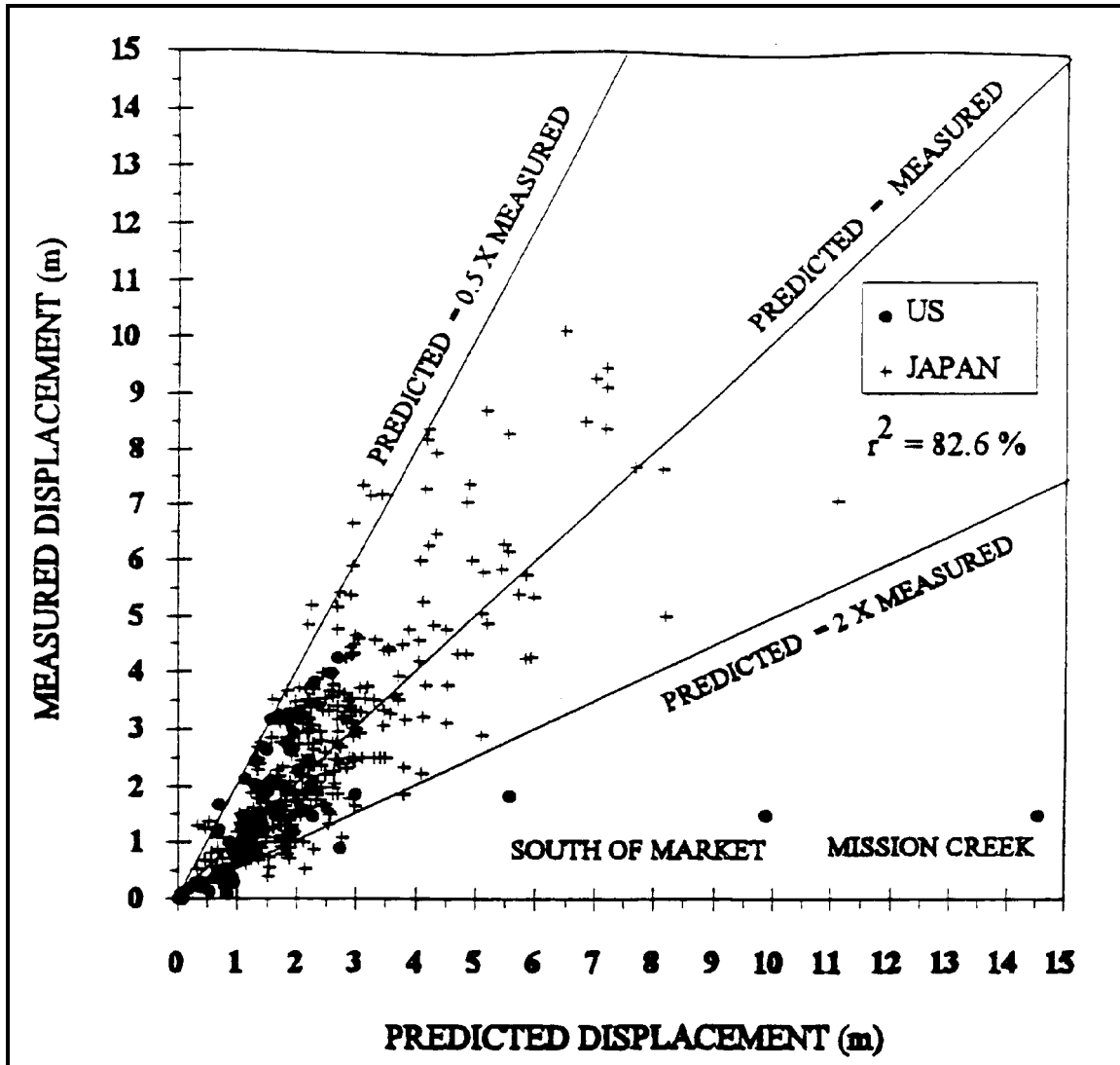

FIGURE C7.4.1-5 Measured displacements plotted against predicted displacements for U.S. and Japanese case-history data (after Bartlett and Youd, 1995).

Similarly, well reinforced foundations that would not fracture could be used in U.S. practice as a mitigative measure to reduce structural damage in areas subject to liquefaction but with limited potential for lateral ( $< 0.3$  m) or vertical ( $< 0.05$  m) ground displacements. Such strengthening also would serve as an effective mitigation measure against damage from other sources of limited ground displacement including fault zones, landslides, and cut fill boundaries. Where slab-on-grade or basement slabs are used as foundation elements, these slabs should be reinforced and tied to the foundation walls to give the structure adequate strength to resist ground displacement. Although strengthening of foundations, as noted above, would largely mitigate damage to the structure, utility connections may be adversely affected unless special flexibility is built into these nonstructural components.

Another possible consequence of liquefaction to structures is increased lateral pressures against basement walls. A common procedure used in design for such increased pressures is to assume that the liquefied material acts as a dense fluid having a unit weight of the liquefied soil. The wall then is designed assuming that hydrostatic pressure for the dense fluid acts along the total subsurface height of the wall. The procedure applies equivalent horizontal earth pressures that are greater than typical at-rest earth pressures but less than passive earth pressures. As a final consideration, to prevent buoyant rise as a consequence of liquefaction, the total weight of the structure should be greater than the volume of the basement or other cavity times the unit weight of liquefied soil. (Note that structures with insufficient weight to counterbalance buoyant effects could differentially rise during an earthquake.)

At sites where expected ground displacements are unacceptably large, ground modification to lessen the liquefaction or ground failure hazard or selection of an alternative site may be required. Techniques for ground stabilization to prevent liquefaction of potentially unstable soils include removal and replacement of soil; compaction of soil in place using vibrations, heavy tamping, compaction piles, or compaction grouting; buttressing; chemical stabilization with grout; and installation of drains. Further explanation of these methods is given by the National Research Council (1985).

*Slope Instability:* The stability of slopes composed of dense (nonliquefiable) or nonsaturated sandy soils or nonsensitive clayey soils can be determined using standard procedures.

For initial evaluation, the pseudostatic analysis may be used. (The deformational analysis described below, however, is now preferred.) In the pseudostatic analysis, inertial forces generated by earthquake shaking are represented by an equivalent static horizontal force acting on the slope. The seismic coefficient for this analysis should be the peak acceleration,  $a_{max}$ , or  $A_a$ . The factor of safety for a given seismic coefficient can be estimated by using traditional slope stability calculation methods. A factor of safety greater than one indicates that the slope is stable for the given lateral force level and further analysis is not required. A factor of safety of less than one indicates that the slope will yield and slope deformation can be expected and a deformational analysis should be made using the techniques discussed below.

Deformational analyses yielding estimates of slope displacement are now accepted practice. The most common analysis uses the concept of a frictional block sliding on a sloping plane or arc. In this analysis, seismic inertial forces are calculated using a time history of horizontal acceleration as the input motion. Slope movement occurs when the driving forces (gravitational plus inertial) exceed the resisting forces. This approach estimates the cumulative displacement of the sliding mass by integrating increments of movement that occur during periods of time when the driving forces exceed the resisting forces. Displacement or yield occurs when the earthquake ground accelerations exceed the acceleration required to initiate slope movement or yield acceleration. The yield acceleration depends primarily on the strength of the soil and the gradient and height and other geometric attributes of the slope. See Figure C7.4.1-6 for forces and equations used in analysis and Figure C7.4.1-7 for a schematic illustration for a calculation of the displacement of a soil block toward a bluff.

The cumulative permanent displacement will depend on the yield acceleration as well as the intensity and duration of ground-shaking. As a general guide, a ratio of yield acceleration to

maximum acceleration of 0.5 will result in slope displacements of the order of a few inches for typical magnitude 6.5 earthquakes and perhaps several feet of displacement for magnitude 8 earthquakes. Further guidance on slope displacement is given by Makdisi and Seed (1978).

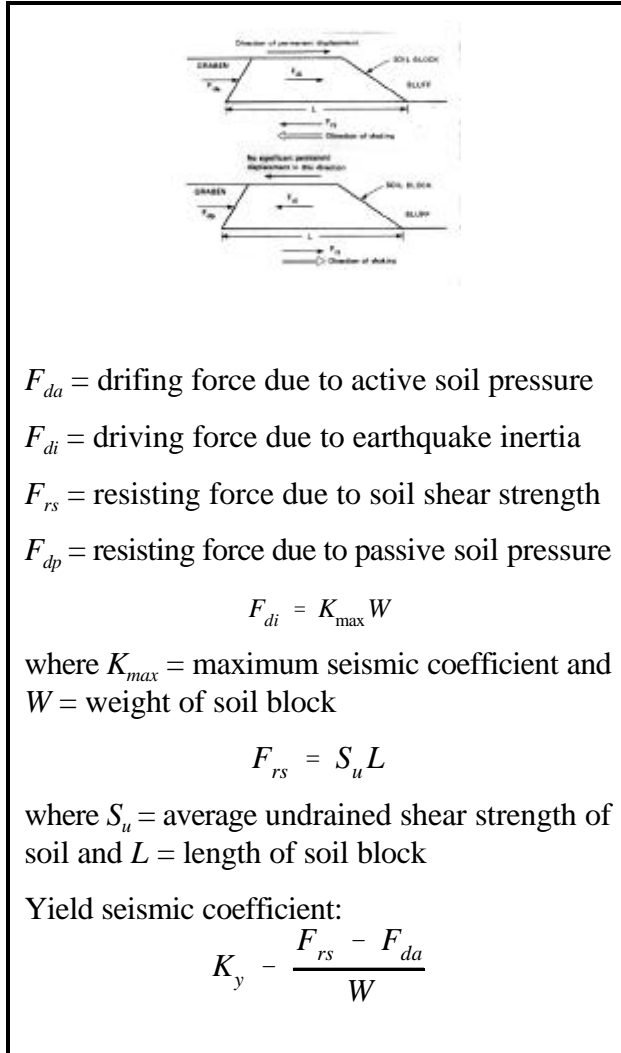

FIGURE C7.4.1-6 Forces and equations used in analysis of translatory landslides for calculating permanent lateral displacements from earthquake ground motions (National Research Council, 1985; from Idriss, 1985).

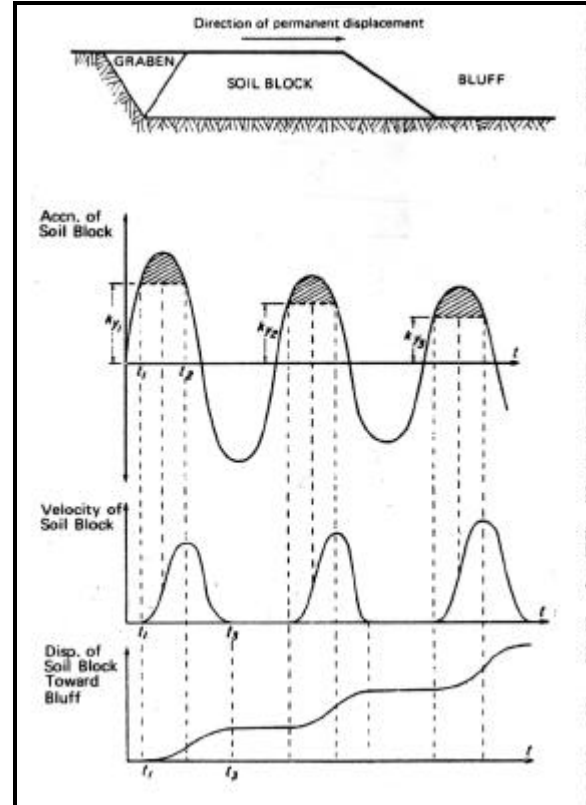

FIGURE C7.4.1-7 Schematic illustration for calculating displacement of soil block toward the bluff (National Research Council, 1985; from Idriss, 1985, adapted from Goodman and Seed, 1966).

*Mitigation of Slope Instability Hazard:* With respect to slope instability, three general mitigative measures might be considered: design the structure to resist the hazard, stabilize the site to reduce the hazard, or choose an alternative site. Ground displacements generated by slope instability are similar in destructive character to fault displacements generating similar senses of movement: compression, shear, extension or vertical. Thus, the general comments on structural design to prevent damage given under mitigation of fault displacement apply equally to slope displacement. Techniques to stabilize a site include reducing the driving forces by grading and

drainage of slopes and increasing the resisting forces by subsurface drainage, buttresses, ground anchors, or chemical treatment.

**7.4.2 POLE-TYPE STRUCTURES:** The use of pole-type structures is permitted. These structures are inherently sensitive to earthquake motions. Bending in the poles and the soil capacity for lateral resistance of the portion of the pole embedded in the ground should be considered and the design completed accordingly.

**7.4.3 FOUNDATION TIES:** One of the prerequisites of adequate performance of a building during an earthquake is the provision of a foundation that acts as a unit and does not permit one column or wall to move appreciably with respect to another. A common method used to attain this is to provide ties between footings and pile caps. This is especially necessary where the surface soils are soft enough to require the use of piles or caissons. Therefore, the pile caps or caissons are tied together with nominal ties capable of carrying, in tension or compression, a force equal to  $C_d/4$  times the larger pile cap or column load.

A common practice in some multistory buildings is to have major columns that run the full height of the building adjacent to smaller columns in the basement that support only the first floor slab. The coefficient applies to the heaviest column load.

Alternate methods of tying foundations together are permitted (e.g., using a properly reinforced floor slab that can take both tension and compression). Lateral soil pressure on pile caps is not a recommended method because the motion is imparted from soil to structure (not inversely as is commonly assumed), and if the soil is soft enough to require piles, little reliance can be placed on soft-soil passive pressure to restrain relative displacement under dynamic conditions.

If piles are to support structures in the air or over water (e.g., in a wharf or pier), batter piles may be required to provide stability or the piles may be required to provide bending capacity for lateral stability. It is up to the foundation engineer to determine the fluidity or viscosity of the soil and the point where lateral buckling support to the pile can be provided (i.e., the point where the flow of the soil around the piles may be negligible).

**7.4.4 SPECIAL PILE REQUIREMENTS:** Special requirements for concrete or composite concrete and steel piles are given in this section. The piles must be connected to the pile caps with dowels.

Although unreinforced concrete piles are common used in certain areas of the country, their brittle nature when trying to conform to ground deformations makes their use in earthquake-resistant design undesirable. Nominal longitudinal reinforcing is specified to reduce this hazard. The reinforcing steel should be extended into the footing to tie the elements together and to assist in load transfer at the top of pile to the pile cap. Experience has shown that concrete piles tend to hinge or shatter immediately below the pile cap so tie spacing is reduced in this area to better contain the concrete. In the case of the metal-cased pile, it is assumed that the metal casing provides containment and also a nominal amount of longitudinal reinforcement in the lower portion of the pile.

Bending stresses in piles caused by transfer of seismic motions from ground to structure need not be considered unless the foundation engineer determines that it is necessary. It has been a convenient analytical assumption to assume that earthquake forces originate in the building and

are transmitted into and resisted by the ground. Actually the force or motion comes from the ground--not the structure. This makes the necessity of interconnecting footings more important, but what is desired is stability--not the introduction of forces.

Possibly the simplest illustration is shown in Figure C7.4.4. Consider a small structure subjected to an external force such as wind; the piles must resist that force in lateral pressure on the lee side of the piles. However, if the structure is forced to move during an earthquake, the wave motion is transmitted through the firmer soils, causing the looser soils at the surface and the building to move. For most structures, the structure weight is negligible in comparison to the weight of the surrounding surface soils. If an unloaded pile were placed in the soil, it would be forced to bend similar to a pile supporting a building.

The primary requirement is stability, and this is best provided by piles that can support their loads while still conforming to the ground motions and, hence, the need for ductility.

**7.5 SEISMIC DESIGN CATEGORIES D, E, AND F:** For Category D, E, or F construction, all the preceding provisions for Categories A, B, and C apply for the foundations, but the earthquake detailing is more severe and demanding. Adequate pile ductility is required and provision must be made for additional reinforcing to ensure, as a minimum, full ductility in the upper portion of the pile.

**7.5.1 INVESTIGATION:** In addition to the potential site hazard discussed in *Provisions Sec. 7.4.1*, consideration of lateral pressures on earth retaining structures shall be included in investigations for Seismic Design Categories D, E, and F.

*Earth Retaining Structures:* Increased lateral pressures on retaining structures during earthquakes have long been recognized; however, design procedures have not been prescribed in U.S. model building codes. Waterfront structures often have performed poorly in major earthquake due to excess pore water pressure and liquefaction conditions developing in relatively loose, saturated granular soils. Damage reports for structures away from waterfronts are generally limited with only a few cases of stability failures or large permanent movements (Whitman, 1991). Due to the apparent conservatism or overstrength in static design of most walls, the complexity of nonlinear dynamic soil-structure interaction, and the poor understanding of the behavior of retaining structures with cohesive or dense granular soils, Whitman (1991) recommends that “engineers must rely primarily on a sound understanding of fundamental principles and of general patterns of behavior.”

For many years, recommendations by Seed and Whitman (1970) have been used widely in design of earth retaining structures for dynamic loads. In this reference, a simplified Mononobe-Okabe seismic coefficient method of analysis was proposed for design practice. At a 1990 Cornell University conference, Whitman (1990) indicated that “the Mononobe-Okabe equation for earth pressure is still used widely for design, although actual conditions during earthquake shaking of retaining structures are quite different from those assumed in developing the equation.” More recently, the design approach based on a permissible displacement (Richards and Elms, 1979) has received wider acceptance. More recent research studies are included in Prakash (1996).

The Mononobe-Okabe method assumes that a wall yields for the backfill to experience an active limiting condition during ground shaking (Seed and Whitman, 1970; Prakash, 1981). If a wall

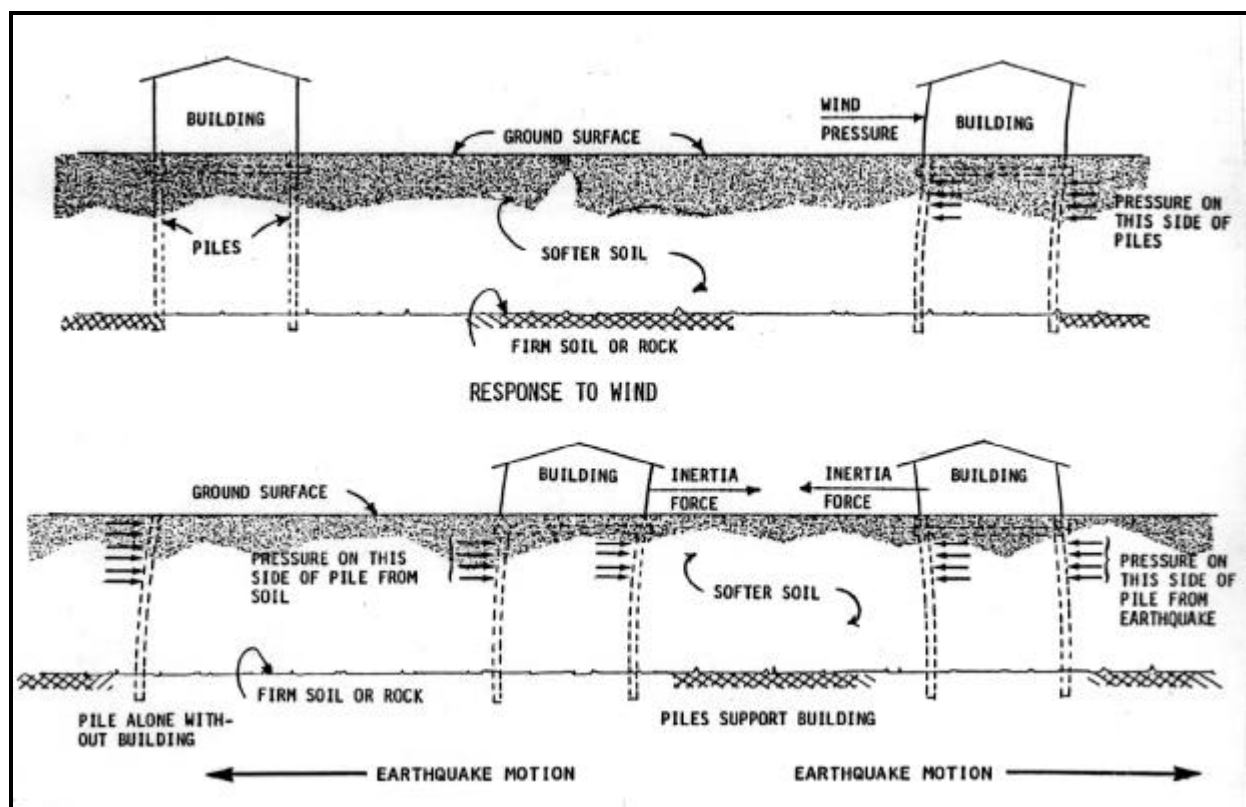

FIGURE C7.4.4 Response to earthquake.

moves rigidly with the underlying base (i.e., nonyielding wall), it is reasonable to expect dynamic pressures larger than the Mononobe-Okabe active case. For the nonyielding wall condition using elastic theory, Wood (1973) provided solutions for material properties being constant with depth. In a parallel model test investigation of this case, Yong (1985) reported that the measured dynamic earth thrust exceeded those predicted by the Mononobe-Okabe equation. Conversely, Chang and coworkers (1990) indicated, based on dynamic earth pressure data recorded on a partially embedded reactor containment model structure, that the magnitude of the dynamic earth pressures were consistent with the Mononobe-Okabe equation.

Exterior basement walls of a multistory building experience dynamic earth pressures during ground shaking through a complex soil-structure interaction (Itoh and Nogami, 1990; Soydemir and Celebi, 1992) in which the inertia effect of the superstructure could play a more dominant role than the inertia effect of the soil containing the substructure (i.e., basement walls). In this case there are similarities between basement walls of high-rise buildings and abutment walls of bridges as they perform under ground shaking (Lam and Martin, 1986). Ganey and coworkers (1995) provided dynamic earth pressure data collected at the basement walls of a reinforced concrete tower subjected to earthquake-induced ground shaking having magnitudes exceeding those calculated from the Mononobe-Okabe formulation. It appears that rocking due to the inertia of the superstructure is a source mechanism intimately associated with the dynamic earth pressures generated against the basement walls.

**7.5.2 FOUNDATION TIES:** The additional requirement is made that spread footings on soft soil profiles should be interconnected by ties. The reasoning explained above under Sec. 7.4.3 also applies here.

**7.5.3 SPECIAL PILE REQUIREMENTS:** Additional pile reinforcing over that specified for Category C buildings is required. The reasoning explained above under Sec. 7.4.4 applies here.

Special consideration is required in the design of concrete piles subject to significant bending during earthquake shaking. Bending can become crucial to pile design where portions of the foundation piles may be supported in soils such as loose granular materials and/or soft soils that are susceptible to large deformations and/or strength degradation. Severe pile bending problems may result from various combinations of soil conditions during strong ground shaking.

For example:

1. Soil settlement at the pile-cap interface either from consolidation of soft soil prior to the earthquake or from soil compaction during the earthquake can create a free-standing short column adjacent to the pile cap.
2. Large deformations and/or reduction in strength resulting from liquefaction of loose granular materials can cause bending and/or conditions of free-standing columns.
3. Large deformations in soft soils can cause varying degrees of pile bending. The degree of pile bending will depend upon thickness and strength of the soft soil layer(s) and/or the properties of the soft/stiff soil interface(s).

Such conditions can produce shears and/or curvatures in piles that may exceed the bending capacity of conventionally designed piles and result in severe damage. Analysis techniques to evaluate pile bending are discussed by Margason and Holloway (1977) and these effects on concrete piles are further discussed by Shepard (1983). For homogeneous, elastic media and assuming the pile follows the soil, the free-field curvature (soil strains without a structure present) can be estimated by dividing the peak ground acceleration by the square of the shear wave velocity of the soil although considerable judgment is necessary in utilizing this simple relationship in a layered, inelastic profile with pile-soil interaction effects. Norris (1994) discusses methods to assess pile-soil interaction with regard to pile foundation behavior.

The designer needs to consider the variation in soil conditions and driven pile lengths in providing for pile ductility at potential high curvature interfaces. Interaction between the geotechnical and structural engineers is essential.

It is prudent to design piles to remain functional during and following earthquakes in view of the fact that it is difficult to repair foundation damage. The desired foundation performance can be accomplished by proper selection and detailing of the pile foundation system. Such design should accommodate bending from both reaction to the building's inertial loads and those induced by the motions of the soils themselves. Examples of designs of concrete piles include:

1. Use of a heavy spiral reinforcement and
2. Use of exterior steel liners to confine the concrete in the zones with large curvatures or shear stresses.



These provide proper confinement to ensure adequate ductility and maintenance of functionality of the confined core of the pile during and after the earthquake.

## REFERENCES

- Bartlett, S. F., and T. L. Youd. 1992. *Empirical Analysis of Horizontal Ground Displacement Generated by Liquefaction-Induced Lateral Spread*, Technical Report NCEER-92-0021. Buffalo, New York: National Center for Earthquake Engineering Research.
- Bartlett, S. F., and T. L. Youd. 1995. "Empirical Prediction of Liquefaction-Induced Lateral Spread." *Journal of Geotechnical Engineering ASCE* 121(4): 316-329.
- Bertero, V. V., and H. A. Brauer, G. C. Fotinos, G. C. Gerwick, Jr., Y. T. Lin, and H. B. Seed. 1974. "Aseismic Design of Prestressed Concrete Piling." In *Proceedings of the 7th Congress of the Federation Internationale de la Precontrainte*, New York, May 25.
- Bieganousky, W. A., and E. F. Marcuson, III. 1976. *Liquefaction Potential of Dams and Foundations: Report 1--Laboratory Standard Penetration Test on Reid Bedford Model and Ottawa Sands*, Report S-76-2. Waterways Experiment Station.
- Bieganousky, W. A., and W. F. Marcuson, III. 1977. *Liquefaction Potential of Dams and Foundations: Report 2--Laboratory Standard Penetration Test on Platte River Sand and Standard Concrete Sand*, Report S-762. Waterways Experiment Station.
- Bonilla, M. G., R. K. Mark, and J. J. Lienkaemper. 1984. "Statistical Relations Among Earthquake Magnitude, Surface Rupture Length, and Surface Fault Displacement." *Bulletin of the Seismological Society of America* 74(6):2379-2411.
- Building Research Institute of Japan. *Report on the Damage by the 1978 Off Miyagi Prefecture Earthquake*, Report 86, pp. 319-341.
- California Department of Transportation. 1971. *The San Fernando Earthquake--Field Investigation of Bridge Damage: Preliminary Report*. Sacramento: CALTRANS.
- Castro, G. 1975. "Liquefaction and Cyclic Mobility of Saturated Sands." *Journal of the ASCE Geotechnical Engineering Division* 101 (GT6):551-569.
- Chang, C. Y., M. S. Power, C. M. Mok, Y. K. Tang, and H. T. Tang. 1990. "Analysis of Dynamic Lateral Earth Pressures Recorded on Lotung Reactor Containment Model Structure," in *Proceedings, Fourth U.S. National Conference on Earthquake Engineering*, pp. 643-652. EERI.
- Dewa, Herose, Saito, and Ohira. 1980. "Earthquake Observations and Analysis of LNG Tank on Pile Foundations." In *Proceedings of the 7th World Conference on Earthquake Engineering*, Istanbul.
- Earthquake Engineering Research Institute. 1986. "Geotechnical Engineering." In *Reducing Earthquake Hazards: Lessons Learned from Earthquakes*, Publication 86-02, pp. 23-52. El Cerrito, California: Earthquake Engineering Research Institute.

- Ganev, T., F. Yamazaki, and T. Katayama. 1995. "Observation and Numerical Analysis of Soil-Structure Interaction of a Reinforced Concrete Tower." *Journal of Earthquake Engineering and Structural Dynamics* 24: 491-503.
- Gerwick, B. C. Jr. 1982. "Seismic Design of Prestressed Concrete Piles." In *Proceedings of the 9th Congress of the Federation Internationale de la Precontrainte*, Vol. 2, pp. 60-69.
- Gerwick, B. C., Jr., and H. A. Brauner. 1970. *Design of High-Performance Prestressed Concrete Piles for Dynamic Loading*. New York: American Society for Testing and Materials.
- Hardman, Scott L., and T. Leslie Youd. 1987. *State of the Art for Assessing Earthquake Hazards in the United States*, Miscellaneous Paper S-73-1. Vicksburg, Mississippi: U.S. Army Waterways Experiment Station.
- Hart, E. W. 1988. *Fault-Rupture Hazard Zones in California*, Special Publication 42. Sacramento: California Division of Mines and Geology.
- Idriss, I. M. 1989. "Response of Soft Soil Sites During Earthquakes." In *Proceedings of the H. Bolton Seed Memorial Symposium*, Vol. 2, pp. 273-289.
- Idriss, I. M. 1985 "Evaluating Seismic Risk in Engineering Practice." In *Proceedings of the 11<sup>th</sup> International Conference on Soil Mechanics and Foundation Engineering*, Vol 1, p. 155.
- Ishihara, Kenji. 1985. "Stability of Natural Deposits During Earthquakes." In *Proceedings of the 11<sup>th</sup> International Conference on Soil Mechanics and Foundation Engineering*, San Francisco, Vol. 1, pp. 321-376.
- Itoh, T. and T. Nogami. 1990. "Effects of Surrounding Soil on Seismic Response of Building Basements," in *Proceedings, Fourth U.S. National Conference on Earthquake Engineering*, pp. 643-652. EERI.
- Kishida, Hanazuto, and Nakai. 1980. "Damage of Reinforced Precast Concrete Piles During the Miyagi-Oki Earthquake of June 12, 1981." In *Proceedings of the 7th World Conference on Earthquake Engineering, Istanbul*, Vol. 9, p. 461.
- Kishida. "Damage of Reinforced Concrete Buildings in Niigata City with Special Reference to Foundation Engineering." *Soils and Foundations* 6(1):71-86.
- Koester, J. P., and A. G. Franklin. 1985. *Current Methodologies for Assessing the Potential for Earthquake Induced Liquefaction in Soils*, Report NUREG/CR-4430 RA. Washington, D.C.: U.S. Nuclear Regulatory Commission.
- Lam, I., and G. R. Martin. 1986. *Seismic Design of Highway Bridge Foundations -- Design Procedures and Guidelines*, Report FHWA/RD-86/102. Washington, D.C.: FHWA.
- Ledbetter, R. H. 1985. *Improvement of Liquefiable Foundation Conditions Beneath Existing Structures*, Technical Report REMR-GT-2. Vicksburg, Mississippi: U.S. Army Waterways Experiment Station.
- Makdisi, F. T., and H. B. Seed. 1978. "Simplified Procedure for Estimating Dam and Embankment Earthquake-Induced Deformations." *Journal of Geotechnical Engineering ASCE* 104(GT7):849-867.

- Margason, E., and M. Holloway. 1977. "Pile Bending During Earthquakes." In *Proceedings of the 6th World Conference on Earthquake Engineering, New Dehli*.
- Nadim, F. 1982. A Numerical Model for Evaluation of Seismic Behavior of Gravity Retaining Walls, Doctoral Thesis Research Report R82-33, Department of Civil Engineer, Massachusetts Institute of Technology, Cambridge.
- National Research Council, Committee on Earthquake Engineering. 1985. *Liquefaction of Soils During Earthquakes*. Washington, D.C.: National Academy Press.
- Nodar, Setsuo, and Satoshi Hayashi. 1980. "Damage to Port Structures in the 1978 Miyagi-Kenoki Earthquake." In *Proceedings of the 7th World Conference on Earthquake Engineering, Istanbul*, Vol. 9, p. 415.
- Norris, G. M. 1994. "Seismic Bridge Pile Foundation Behavior," in *Proceedings, International Conference on Design and Construction of Deep Foundations*, FHWA, Vol. 1.
- Park, R., and T. J. Falconer. 1983. "Ductility of Prestressed Concrete Piles Subjected to Seismic Loading." *PCI Journal* (September/October).
- Poulos, S. J., G. Castro, and J. W. France. 1985. "Liquefaction Evaluation Procedures." *ASCE Journal of Geotechnical Engineering* 111(6).
- Prakash, S., Editor. 1996. *Analysis and Design of Retaining Structures Against Earthquakes*, Geotechnical Special Publication 601. Washington, D.C.: American Society of Civil Engineers.
- Prakash, S. 1981. *Soil Dynamics*. New York: McGraw-Hill Book Co.
- Richards, R. J., and D. Elms. 1979. "Seismic Behavior of Gravity Retaining Walls." *Journal of the Geotechnical Engineering Divisions, ASCE* 105(GT4): 449-464.
- Rollins, Kyle M. 1987. The Influence of Buildings on Potential Liquefaction Damage. Ph.D. dissertation, University of California, Berkeley.
- Seed, H. B. 1987. "Design Problems in Soil Liquefaction." *ASCE Journal of Geotechnical Engineering* 113(8).
- Seed, H. B., I. Arango, and C. K. Chan. 1975. *Evaluation of Soil Liquefaction Potential During Earthquakes*, Report EERC 75-28. Berkeley, California: Earthquake Engineering Research Center.
- Seed, H. B., and W. H. Peacock. 1971. "Test Procedures for Measuring Soil Liquefaction Characteristics." *Journal of the ASCE Soil Mechanics and Foundation Division* 97(SM8), Paper 8330.
- Seed, H. B., and I. M. Idriss. 1971. "Simplified Procedure for Evaluating Soil Liquefaction Potential." *Journal of the ASCE Soil Mechanics and Foundations Division* 97(SM9):1249-1273.
- Seed, H. B., Mori, Kenji, and C. K. Chan. 1977. "Influence of Seismic History on the Liquefaction of Sands." *Journal of the ASCE Geotechnical Engineering Division* (April).

- Seed, H. B. 1976. "Evaluation of Soil Liquefaction Effects of Level Ground During Earthquakes." In *Liquefaction Problems in Geotechnical Engineering, Proceedings of the ASCE National Convention*.
- Seed, H. B., K. Tokimatsu, L. F. Harder, and R. M. Chung. 1985. *The Influence of SPT Procedures in Soil Liquefaction Resistance Evaluations*, Report UBC/EERC-84/15. Berkeley, California: Earthquake Engineering Research Center.
- Seed, H. B., I. M. Idriss, and I. Arango. 1983. "Evaluation of Liquefaction Potential Using Field Performance Data." *ASCE Journal of Geotechnical Engineering* 109(3):458-482.
- Seed, H. B., and I. M. Idriss. 1982. *Ground Motions and Soil Liquefaction During Earthquakes*, Vol. 5 of *Engineering Monographs on Earthquake Criteria, Structural Design, and Strong Motion Records*. El Cerrito, California: Earthquake Engineering Research Institute.
- Seed, R. B., and L. F. Harder. 1989. "SPT-Based Analysis of Cyclic Pore Pressure Generation and Undrained Residual Strength." In *Proceedings of the H. Bolton Seed Memorial Symposium*, Vol. 2, pp. 351-376.
- Seed, H. B., and R. V. Whitman. 1970. "Design of Earth Retaining Structures for Dynamic Loads," in *Proceedings, ASCE Specialty Conference on Lateral Stresses in the Ground and Design of Earth-Retaining Structures*, pp. 103-147. Ithaca, New York: Cornell University.
- Shepard, D. A. 1983. "Seismic Design of Concrete Piling." *PCI Journal* (March/April).
- Slemmons, D. B., P. Bodin, and X. Zhang. 1989. "Determination of Earthquake Size from Surface Faulting Events." In *Proceedings of the International Seminar on Seismic Zonation*, Guangzhou, China, pp. 157-169.
- Soydemir, C., and M. Celebi. 1992. "Seismic Design of Buildings with Multi-Level Basements," in *Proceedings, Tenth World Conference on Earthquake Engineering*, Madrid Spain, Vol. 6, pp. 1731-1734.
- Sugimura. 1981. "Earthquake Damage and Design Method of Piles." In *Proceedings of the 10th International Conference on Soil Mechanics and Foundation Engineering*, Stockholm.
- Sugimura. 1980. "Participation Factor of Horizontal Force Applied to Pile Foundation." In *Proceedings of the 7th World Conference on Earthquake Engineering, Istanbul*, Vol. 3, p. 443.
- Tamura et al. 1973. "Damage of Bridges During the Tokachi-Oki Earthquake (1968)." In *Proceedings of the Japan Earthquake Engineering Symposium*, pp. 147-153.
- Tokimatsu, K., and H. B. Seed. 1987. "Evaluation of Settlements in Sands Due to Earthquake Shaking." *Journal of Geotechnical Engineering ASCE* 113(8):861-878.
- Whitman, R. V. 1991. "Seismic Design of Earth Retaining Structures," in *Proceedings, Second International Conference on Recent Advances in Geotechnical Earthquake Engineering and Soil Dynamics*, St. Louis, Missouri.
- Whitman, R. V. 1990. "Seismic Design and Behavior of Gravity Retaining Walls," in *Proceedings, ASCE Specialty Conference on Lateral Stresses in the Ground and Design of Earth-Retaining Structures*, pp. 817-842. Ithaca, New York: Cornell University.

Wood, J. H. 1973. *Earthquake-Induced Soil Pressures on Structures*, Report EERL 73-05. Pasadena: California Institute of Technology.

Yong, P. M. F. 1985. *Dynamic Earth Pressure Against a Rigid Earth Retaining Wall*, Central Laboratory Report 5.8515. Lower Hutt, New Zealand: Ministry of Work and Development.

Youd, T. L. 1993. *Liquefaction-Induced Lateral Spread Displacement*. NCEL Technical Note N-1862. Washington, D.C.: U.S. Navy.

Youd, T. L. 1989. "Ground Failure Damage to Buildings During Earthquakes." In *Foundation Engineering--Current Principles and Practices*, Vol. 1, pp. 758-770. New York: American Society of Civil Engineers.

## Chapter 8 Commentary

### STEEL STRUCTURE DESIGN REQUIREMENTS

**8.1 REFERENCE DOCUMENTS:** The reference documents presented in this section are the current specifications for the design of steel members, systems, and *components* in *buildings* as approved by the American Institute of Steel Construction (AISC), the American Iron and Steel Institute (AISI), the American Society of Civil Engineers (ASCE) and the Steel Joist Institute (SJI).

#### **8.2 SEISMIC REQUIREMENTS FOR STEEL STRUCTURES:**

**8.3 SEISMIC DESIGN CATEGORIES A, B, AND C:** Structures assigned to Seismic Design Categories A, B, and C do not require the same level of ductility capacity to provide the required performance as those assigned to the higher categories. For this reason, such structures are permitted to be designed using the requirements of any of the listed references, provided that the lower  $R$  value specified in Table 5.2.2 is used. Should the registered design professional choose to use the higher  $R$  values in the table, it is required that the detailing requirements for the higher Seismic Design Categories be used.

**8.4 SEISMIC DESIGN CATEGORIES D, E, AND F:** Structures assigned to these categories must be designed in anticipation of significant ductility demands that may be placed on the structures during their useful life. Therefore, structures in these categories are required to be designed to meet special detailing requirements as referenced in this section.

**8.5 COLD-FORMED STEEL SEISMIC REQUIREMENTS:** The allowable stress and allowable load levels in Ref. 8-4 are incompatible with the force levels in Chapter 5 of the *Provisions*. It is therefore necessary to modify the provisions of Ref. 8-4 for use with the *Provisions*. Ref. 8-5 and 8-6 are both based on LRFD and thus are consistent with the force levels in Chapter 5 of the *Provisions*. As such, only minor modifications are needed to correlate those load factors for seismic loads to be consistent with these provisions. The modifications of all of the reference documents affect only designs involving seismic loads.

**8.6 LIGHT-FRAMED WALLS:** The provisions of this section apply to buildings framed with cold-formed steel studs and joists. Lateral resistance is typically provided by diagonal braced (braced frames) or wall sheathing material. This section is only required for use in Seismic Design Categories D, E, and F. The required strength of connections is intended to assure that inelastic behavior will occur in the connected members prior to connection failure. Since pull-out of screws is a sudden or brittle type of failure, designs using pull-out to resist seismic loads are not permitted. Where diagonal members are used to resist lateral forces, the resulting uplift forces must be resolved into the foundation or other frame members without relying on the bending resistance of the track web. This often is accomplished by directly attaching the end stud(s) to the foundation, frame, or other anchorage device.

Table 8.6 presents nominal shear values for plywood and oriented strand board attached to steel stud wall assemblies. Design values are determined by multiplying the nominal values by a phi ( $\phi$ ) factor as presented in Sec. 8.6.5. These nominal values are based upon tests performed at Santa Clara University (Serrette, 1996). The test program included both cyclic and static tests; however, the values presented in Table 8.6 are based upon the cyclic tests as they are intended for use in seismic resistance. In low seismic areas where wind loads dominate, nominal values have been recommended for wind resistance by AISI based upon monotonic tests (AISI, 1996). The cyclic tests were performed using the assemblies that were determined to be the most critical from the static tests. The assemblies cyclically tested consisted of 3.5 x 1.625 inch C studs fabricated with ASTM A446 Grade A (33 ksi) with a minimum base metal thickness of 0.033 inch. Since the tests were conducted, ASTM A446 Grade A has been redesignated ASTM A653 SQ Grade 33. The test panels were four feet wide and 8 feet high, the sheathing material was applied vertically to only a single side of the studs, and there was no sheathing or bracing applied to the other side.

The cyclic tests were performed using a sequential phase displacement protocol under development at the time of the test by an *ad hoc* Committee of the Structural Engineers Association of Southern California. Nominal values were conservatively established by taking the lowest load in the last set of stable hysteretic loops. It is expected that subsequent testing of steel stud shear wall assemblies will reduce or modify some of the restrictive limits currently proposed for the use of the system such as the nominal maximum thickness of the studs of 0.043 inch, the aspect ratio of 2:1, and the ability to use sheathing on both sides of the wall.

**8.7 SEISMIC REQUIREMENTS FOR STEEL DECK DIAPHRAGMS:** Since the design values for steel deck are based on allowable loads, it is necessary to present a method of deriving design strengths. Two  $\phi$  values are presented — 0.60 for steel deck that is mechanically attached and 0.50 for welded steel deck. These factors are consistent with current proposals being circulated for inclusion in updates of Ref. 8-5.

**8.5 STEEL CABLES:** The provisions of Sec. 8.5 are virtually unchanged from previous editions. Although the provisions in Ref. 8-8 are dated, they are the only ones available and there was no sentiment to eliminate them from the *Provisions*. The allowable stress levels of steel cable structures specified in Ref. 8.8 are modified for seismic load effects. The value of  $1.5T_4$  was chosen as a reasonable value to compare with increases given to other working stress levels.

**REFERENCES:**

Serrette. 1996. *Shear Wall Values for Light Weight Steel Framing*. American Iron and Steel Institute.

## Chapter 9 Commentary

### CONCRETE STRUCTURE DESIGN REQUIREMENTS

**9.1 REFERENCE DOCUMENT:** The main concern of Chapter 9 is the proper detailing of reinforced concrete construction for earthquake resistance. The bulk of the detailing requirements in this chapter are contained in Ref. 9-1, Building Code Requirements for Reinforced Concrete, ACI 318-95. The commentary for ACI 318-95 contains a valuable discussion of the rationale behind detailing requirements that is not repeated here.

**9.1.1 MODIFICATIONS TO REF. 9-1:** The modifications noted for ACI 318-95 are: changes in load factors necessary to coordinate with the equivalent yield basis of this document; additional definitions necessary for seismic design requirements for structural systems composed of precast elements; and changes that incorporate certain features of the detailing requirements for reinforced concrete that have been adopted into the 1997 *Uniform Building Code*.

Included as Sec. 9.1.1.5 is a statement on reinforced concrete structural systems incorporating precast concrete elements. One design alternative is emulation of monolithic reinforced concrete construction. The other alternative is the use of the unique properties of precast elements interconnected predominately by dry joints. For the first alternative Sec. 9.1.1.5, 9.1.1.6 and 9.1.1.9 define design procedures ensuring that the resulting structural systems have strength and stiffness characteristics equivalent to those for monolithic reinforced concrete construction. The existing code requirements for monolithic construction then apply for all but the connections. The second alternative, the Appendix to Chapter 9, is included for information and for trial design by users.

Procedures for structural system composed from precast elements interconnected predominately by dry joints are included as an appendix because the existing state of knowledge makes it premature to propose code requirements based on that information. The complexity of structural systems, configurations and details possible with precast concrete elements requires:

1. Selecting functional and compatible details for connections and members that are reliable and can be built with acceptable tolerances;
2. Verifying experimentally the inelastic force-deformation relationships for welded, bolted, or grouted connections proposed for the seismic resisting elements of the structure; and
3. Analyzing the structure using those connection relationships and the inelastic reversed cyclic loading effects imposed by the anticipated earthquake ground motions.

Research conducted to date (Cheok and Lew, 1991; Elliott et al., 1992; Englekirk, 1987; French et al., 1989; BSSC, 1987; Hawkins and Englekirk, 1987; Jayashanker and French, 1988; Mast, 1992; Nakaki and Englekirk, 1991; Neille, 1977; New Zealand Society, 1991; Pekau and Hum,



1991; Powell et al., 1993; Priestley and Tao, 1991; Stanton et al., 1986; Stanton et al., 1991) documents concepts for design using dry connections and the behavior of structural systems and subassemblages composed of precast elements both at and beyond peak strength levels for nonlinear reversed cyclic loadings, and provides the basis for the appendix.

*Emulation of Monolithic Construction Using Strong Connections:* For emulation of the behavior of monolithic reinforced concrete construction, Sec. 9.1.1.6 provides two alternatives. Sec. 21.2.2.6 in Sec. 9.1.1.6 covers structural systems with "wet" connections. Sec. 21.2.2.7 in Sec. 9.1.1.6 covers structural systems with "strong" connections.

For frame systems that use strong connections, Sec. 21.2.2.7 and 21.2.7, the different connection categories envisaged are shown in Figure C9.1.1-1. Considerable freedom is given to locating the nonlinear action zones (plastic hinges) along the length of the precast member. However, those hinges must be separated from the connection by a distance of at least three quarters of the member's depth. Wet-joint connections are permitted at the strong connection but not at the hinge location.

Provision 21.2.7.2 makes the strength required for a strong connection dependent on the distances hinges are separated from that connection, the strengths of those hinges and the nonlinear deformation mechanism envisaged. The conditions described by Sec. 21.2.7.2 for a beam to continuous column connection are shown in Figure C9.1.1-2, which is an adaptation of Figure R21.3.4 of Ref. 9-1. Because the strong connection must not yield or slip; its nominal strengths,  $S_n$  CONNECTION, in both flexure and shear must be greater than those corresponding to development of the probable strengths  $M_{pr1}$  and  $M_{pr2}$  at the hinge locations. Figure C9.1.1-2b, illustrates the situation for flexure. Per Ref. 9-1 moments  $M_{pr1}$  and  $M_{pr2}$  are determined using a strength reduction factor of 1.0 and reinforcing steel stresses of at least  $1.25f_y$ .

For columns above the ground floor, moments at a joint may be limited by flexural strengths of the beams framing into that joint. However, for a strong column-weak beam deformation mechanism, dynamic inelastic analysis and studies of strong motion measurements have shown that beam end moments are not equally divided between top and bottom columns even where those columns have equal stiffness. Elastic analysis predicts moments as shown in Figure C9.1.1-3a while the actual situation is likely to be as shown in Figure C9.1.1-3b. Accordingly, provision 21.2.7.3 is included for the midheight column connection.

*Use of Prestressing Tendons:* Sec. 9.1.1.7 defines conditions under which prestressing tendons can be used, in conjunction with deformed reinforcing bars, in frames resisting earthquake forces. As documented by Ishizuka and Hawkins (1987), if those conditions are met no modification is necessary to the R and Cd factors of Table 2.2.2 when prestressing is used. Satisfactory seismic performance can be obtained when prestressing amounts greater than those permitted by Sec. 9.1.1.6 are used. For example, the connection of Figure C9A-3 has a satisfactory performance for a probable strength of 180 kips and a reversed deformation of 10 mm. However, as documented by Park and Thompson (1977) and Thompson and Park (1980) and required by the combination of New Zealand Standards 3101:1982 and 4203:1992, ensuring that satisfactory performance requires modification of the R and Cd factors.

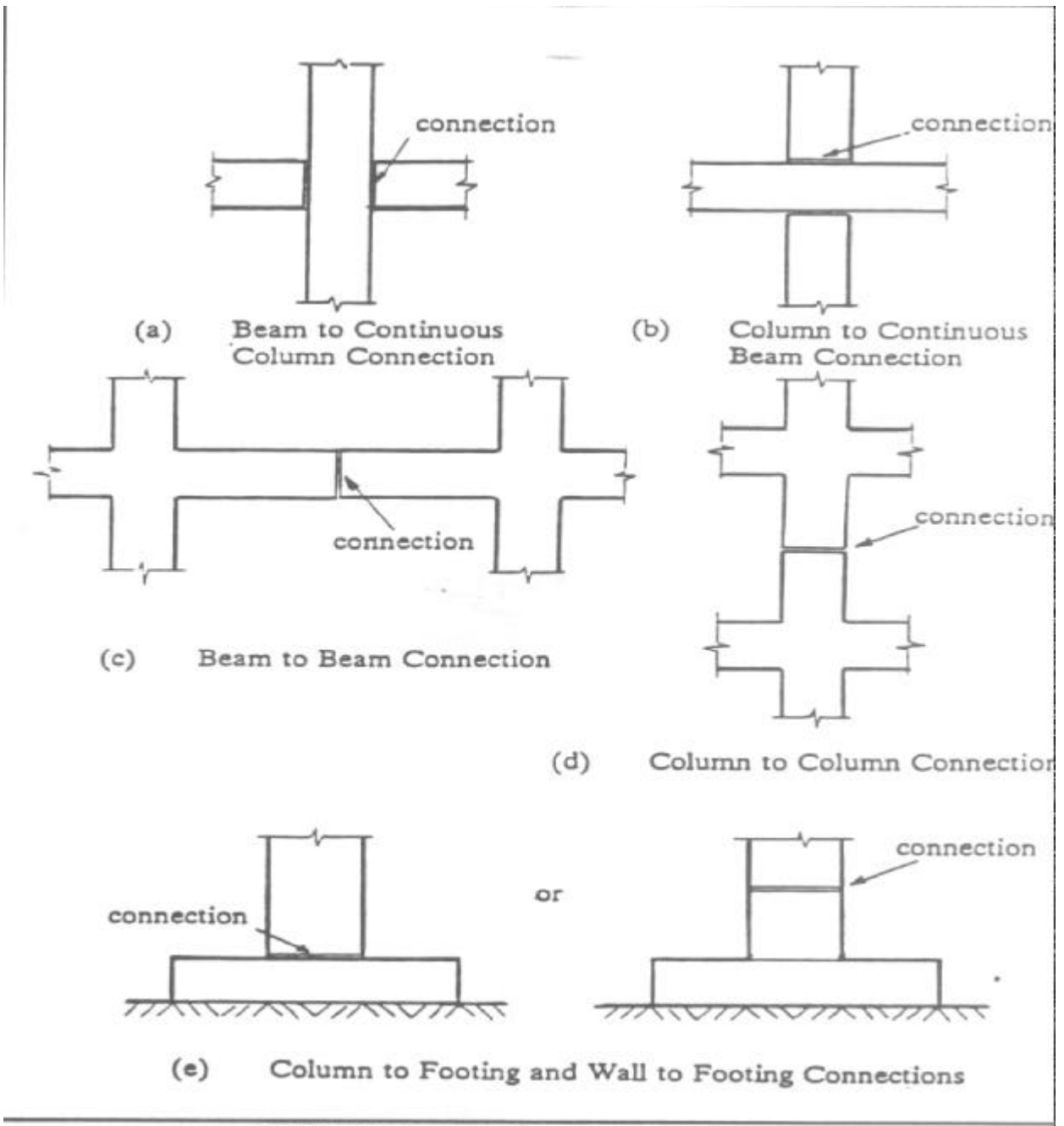

Figure C9.1.1-1 Connection categories

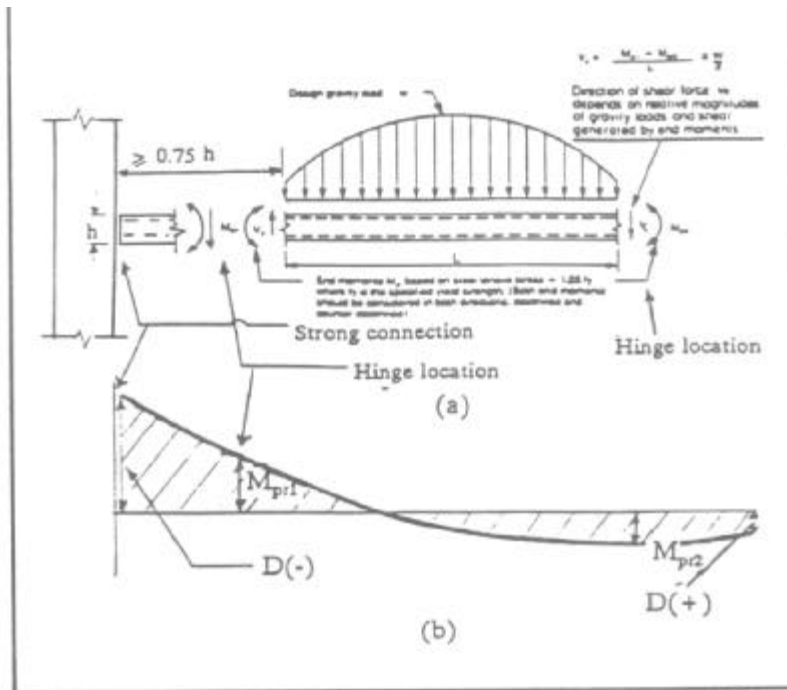

Figure C9.1.1-2 Design forces for strong connections between beams and continuous columns.

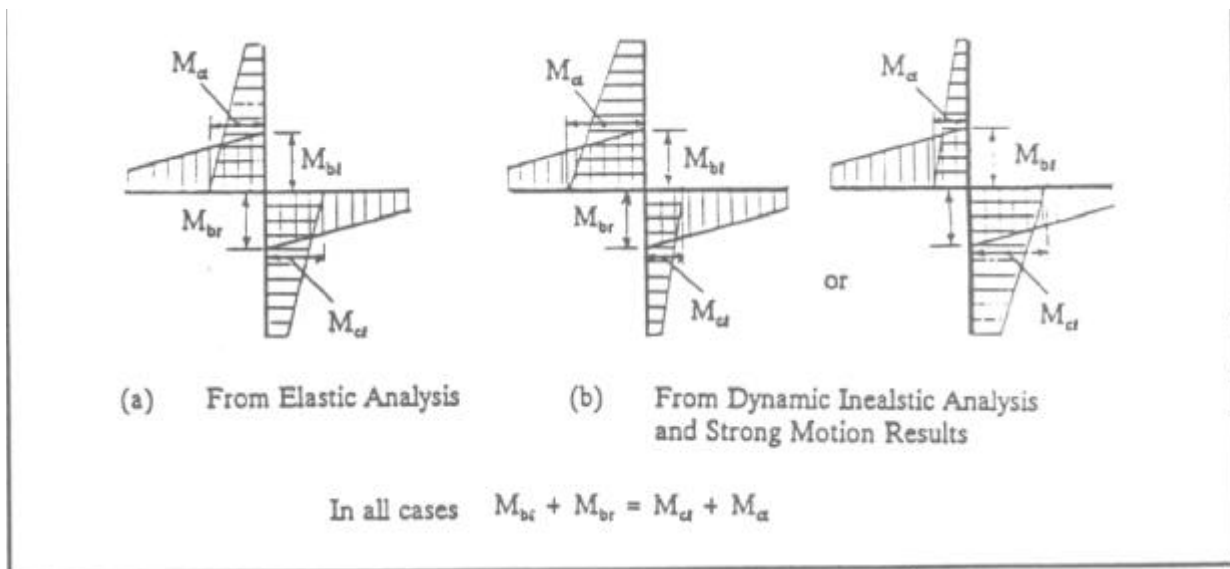

Figure C9.1.1-3 Moments at beam-to-column connections.

**9.1.1.12:** The minimum thicknesses for concrete diaphragms reflect current usage in joist and waffle systems and topping slabs for precast floor and roof systems. Bonding of the top slab provides restraint against slab buckling which, for an untopped joist or waffle system, is provided by the webs.

**9.1.1.14 Coupling Beams:** Short-span coupling beams between shear walls, under reversing loads simulating earthquakes, have been experimentally investigated by many researchers (Barney et al., 1978; Bertero and Popov, 1975; Brown and Jirsa, 1971; Hirose et al., 1973; Ma et al., 1976; Paulay and Binney, 1974; Scribner and Wight, 1978; Shiu et al., 1978; Wight and Sozen, 1975).

The tests indicate that short flexural members with small clear-span-to-effective-depth ratios behave differently than slender flexural members. When short coupling beam specimens were subjected to inelastic load cycles, large flexural cracks formed at both beam ends. With increasing load reversals, cracks from each direction of loading interconnected, forming a vertical plane of weakness at each end of a beam. Thus, instead of a conventional truss mechanism, shear transfer across the plane of weakness was provided primarily by aggregate interlock and shear friction. Under subsequent inelastic load cycles, the shear resisting mechanism deteriorated rapidly resulting in a loss of load capacity by "sliding shear."

It was found (Barney et al., 1978; Paulay and Binney, 1974; Shiu et al., 1978) that increasing the number of hoop stirrups was not effective in improving resistance against sliding shear. Therefore, various configurations of special shear reinforcement to improve seismic performance of short coupling beams were tested (Barney et al., 1978; Bertero and Popov, 1974; Paulay and Binney, 1974; Scribner and Wight, 1978). Full-length diagonal reinforcement was found to produce the greatest energy dissipation and deformation capacities.

In tests at the Portland Cement Association (Shiu et al., 1978), beam specimens with clear-span-to-effective-depth ratio of 2.8 were able to sustain over 34 reversing load cycles. A maximum nominal shear stress of  $12.5\% \delta f_{EQ} \ O(,c)$  was recorded and a maximum imposed deformation of over nine times yield deflection was measured. In addition, the specimen was able to dissipate three times more energy than a comparable specimen without diagonal shear reinforcement. No sign of sliding shear was observed at completion of testing. Similar results have been reported by Paulay and Binney (1974). In both investigations, diagonal shear reinforcement was designed by the proposed equation to resist the total shear force by truss action.

Based on test results, Paulay (1977) recommended that diagonal shear reinforcement be used to carry 75 percent of the induced shear in flexural members when nominal design shear stress under load reversals is larger than  $3\% \delta f_{EQ} \ O(,c)$  psi. When nominal shear stress exceeds  $4.5\% \delta f_{EQ} \ O(,c)$  psi, he recommended that diagonal reinforcement should carry 100 percent of the induced cyclic shear forces.

For clear-span-to-effective-depth ratios greater than 4.0, PCA tests (Barney et al., 1978; Shiu et al., 1978) indicated that specimens with conventional longitudinal reinforcement resisted over 46

inelastic reversing load cycles. At the same time, maximum deformation of 13 times yield deflection was measured. Therefore, experimental data have shown that beams with clear-span-to-effective-depth ratios greater than 4.0 do not require diagonal reinforcement. In addition, diagonal reinforcement is not very effective in beams with clear-span-to-effective-depth ratios greater than 4.0.

It is permitted to use reinforcement arrangements without the diagonal bars if it is assumed that the coupling beams may fail early in the design earthquake and the consequences of such failures are taken into account. The consequences include, but are not necessarily limited to, reductions in stiffness due to lack of coupling between walls as well as debris or deformed members blocking exits and damage or failure of nonstructural components and cladding and the connections thereto due to increased drifts. The vertical load carrying capacity of the structure must not be impaired.

Even if the coupling beams are expected to fail early in the earthquake, the full design strength of the coupling beams still must be provided if they are assumed to be part of the seismic force resisting system. This is to reduce the likelihood that the transition of shear wall behavior from coupled to uncoupled action will begin at unduly low seismic loads.

**9.2 BOLTS AND HEADED STUD ANCHORS IN CONCRETE:** The allowable loads on anchor bolts have been chosen to suit the capacity reduction factors in this document.

**9.2.2 BOLTS AND HEADED STUD ANCHORS:** These requirements follow those given in the Uniform Building Code modified by recent improvements in shear capacity calculation given in the *PCI Design Handbook*, Fourth Edition.

While the requirements do not prohibit the use of single anchor connections, it is considered necessary to use at least two anchors in any load-carrying device whose failure might lead to collapse.

The requirements generally relate to groups of anchors attaching a loaded steel plate to the concrete surface. The thickness of this connector plate also is a design consideration and must be adequate to allow the anchors to perform in group action if the calculated design strengths are to be realized. A plate thickness of not less than one half the diameter of the anchor shank is recommended.

These requirements are intended to provide proper strength of connections. To achieve adequate ductility for seismic or other dynamic loads, use of auxiliary reinforcement for confining concrete or for direct load transfer should be considered. A number of tests have shown that hairpins or similar reinforcement confining the concrete engaged by the anchors and running through the failure surface into the adjacent concrete provides enhancement of a connection's ductility under dynamic loading. No clear recommendations as to the design of such reinforcement have been suggested, but its use is highly recommended in all anchor connections and particularly those subject to seismic or other dynamic loading.

Tests have shown that there are consistent shear ductility variations between bolts anchored to drilled or punched plates with nuts and connections using welded, headed studs.

Recommendations for design are not presently available, but this should also be considered in critical connections subject to dynamic or seismic loading.

### **9.3 CLASSIFICATION OF MOMENT FRAMES:**

**9.3.1.1 ORDINARY MOMENT FRAMES:** Since ordinary frames are permitted only in Categories A and B, they are not required to meet any particular seismic requirements. Attention

should be paid to the often overlooked requirement for joint reinforcement in Sec. 11.12.1 of Ref. 9-1.

**9.3.1.2 INTERMEDIATE MOMENT FRAMES AND 9.3.1.3 SPECIAL MOMENT FRAMES:** The concept of moment frames for various levels of hazard zones and of performance is changed somewhat from the requirements of Ref. 9-1. Two sets of moment frame detailing requirements are defined in Ref. 9-1, one for "regions of high seismic risk" and the other for "regions of moderate seismic risk." For the purposes of this document, the "regions" are made equivalent to Seismic Design Categories in which "high risk" means Categories D and E and "moderate risk" means Category C. This document labels these two frames the "special moment frame" and the "intermediate moment frame," respectively.

The level of inelastic energy absorption of the two frames is not the same. These requirements introduce the concept that the R factors for these two frames should not be the same. The preliminary version of these requirements (ATC 3-06) assigned the R for ordinary frames to what is now called the intermediate frame. In spite of the fact that the R factor for the intermediate frame is less than the R factor for the special frame, use of the intermediate frame is not permitted in the higher Seismic Design Categories (D, E, and F). On the other hand, this arrangement of the Provisions encourages consideration of the more stringent detailing practices for the special frame in Category C because the reward for use of the higher R factor can be weighed against the higher cost of the detailing requirements. These requirements also introduce the concept that an intermediate frame may be a part of a dual system in Category C.

The differences in the performance basis of the requirements for the two types of frames might be briefly summarized as follows (see the commentary of Ref. 9-1 for a fuller discussion of the requirement for the special frame):

1. The shear strength of beams and columns shall not be less than that required when the member has yielded at each end in flexure. For the special frame, strain hardening and other factors are considered by raising the effective tensile strength of the bars to 125 percent of specified yield. For the intermediate frame, an escape clause is provided in that the calculated shear using double the prescribed seismic force may be substituted. Both types require the same minimum amount and maximum spacing of transverse reinforcement throughout the member.

2. The shear strength of joints is limited and special requirements for anchoring bars in joints exist for special moment frames but not intermediate frames. Both frames require transverse reinforcement in joints although less is required for the intermediate frame.
3. Closely spaced transverse reinforcement is required in regions of potential hinging (typically the ends of beams and columns) to control lateral buckling of longitudinal bars after the cover has spalled. The spacing limit is slightly more stringent for columns in the special frame.
4. The amount of transverse reinforcement in regions of hinging for special frames is empirically tied to the concept of providing enough confinement of the concrete core to preserve a ductile response. These amounts are not required in the intermediate frame and, in fact, stirrups in lieu of hoops may be used in beams.

5. The special frame must follow the strong column/weak beam rule. Although this is not required for the intermediate frame, it is highly recommended for multistory construction.
6. The maximum and minimum amounts of reinforcement are limited to prevent rebar congestion and assure a nonbrittle flexural response. Although the precise limits are different for the two types of frames, a great portion of practical, buildable designs will satisfy either.
7. Minimum amounts of continuous reinforcement to account for moment reversals are required by placing lower limits on the flexural strength at any cross section. Requirements for the two types of frames are similar.

8. Locations for splices of reinforcement are more tightly controlled for the special frame.
9. In addition, the special frame must satisfy numerous other requirements beyond the intermediate frame to assure that member proportions are within the scope of the present research experience on seismic resistance and that the analysis, the design procedures, the qualities of the materials, and the inspection procedures are at the highest level of the state of the art.

**9.4 SEISMIC DESIGN CATEGORY A:** Construction qualifying under Category A may be built with no special detailing requirements for earthquake resistance. Special details for ductility and toughness are not required in Category A.

**9.5 SEISMIC DESIGN CATEGORY B:** Special details for ductility and toughness are not required in Category B.

**9.6 SEISMIC DESIGN CATEGORY C:** A frame used as part of the lateral force resisting system in Category C as identified in Table 2.2.2 is required to have certain details that are intended to help sustain integrity of the frame when subjected to deformation reversals into the nonlinear range of response. Such frames must have attributes of intermediate moment frames. Structural (shear) walls of structures in Category C are to be built in accordance with the requirements of Ref. 9-1 except the requirements of Sec. 21.6 of Ref. 9-1 do not apply.

**9.7 SEISMIC DESIGN CATEGORIES D, E, AND F:** The requirements conform to current practice in the areas of highest seismic hazard.

## REFERENCES

### Precast/Prestressed Concrete

ACI Committee 550. 1993. "Design Recommendations for Precast Concrete Structures," ACI Structural Journal 90 (1):115-121.

Applied Technology Council. 1981. Proceedings of a Workshop on Design of Prefabricated Concrete Buildings for Earthquake Loads, Report ATC-8.



Building Seismic Safety Council. 1987. Guide to Use of the NEHRP Recommended Provisions in Earthquake Resistant Design of Buildings, 1985 Edition. Washington, D.C.: FEMA.

Cheok, G. S., and H. S. Lew. 1991. "Performance of Precast Concrete Beam-to-Column Connections Subject to Cyclic Loading," *PCI Journal* 36 (3):56-67.

Clough, D. P. 1986. "A Seismic Design Methodology for Medium-Rise Precast Concrete Buildings." In Proceedings of Seminar on Precast Construction in Seismic Zones, JSPS/NSF, Tokyo, October.

Englekirk, R. E. 1987. "Concepts for the Development of Earthquake Resistant Ductile Frames of Precast Concrete," *PCI Journal* 32(1).

Elliott, K. S., G. Davies, and W. Omar. 1992. "Experimental and Theoretical Investigation of Precast Concrete Hollow-Cored Slabs Uses as Horizontal Floor Diaphragms," *The Structural Engineer* 70(10):175-187.

French, C. W., M. Hafner, and V. Jayashanker. 1989. "Connections Between Precast Elements Failure Within Connection Region," *ASCE Journal of Structural Engineering* 115(12):3171-3192.

Hawkins, N. M., and R. E. Englekirk. 1987. "U.S.-Japan Seminar on P/C Concrete Construction in Seismic Zones," *PCI Journal* 32(2).

Jayashanker, V., and C. E. French. 1988. An Interior Moment Resistant Connection Between Precast Elements Subjected to Cyclic Lateral Loads, Structural Engineering Report 87-10. Minneapolis: University of Minnesota.

Mast, R. F. 1992. "A Precast Concrete Frame System for Seismic Zone Four," *PCI Journal* 37(1):50-64.

Mattock, A. H. 1977. Shear Transfer Under Cyclically Reversing Loading Across an Interface Between Concretes Cast at Different Times, Report SM 77-1. Seattle: Department of Civil Engineering, University of Washington.

Mattock, A. H. 1974. The Shear Transfer Behavior of Cracked Monolithic Concrete Subject to Cyclically Reversing Shear, Report SM 74-4. Seattle: Department of Civil Engineering, University of Washington.

Menegotto, M. 1994. "Seismic Diaphragm Behavior of Untopped Hollow-Core Floors." In Proceedings, Federation International of Prestressing (FIP) Congress, Washington, D.C., May.

Mueller, P. 1989. "Hysteric Behavior of Precast Panel Walls." In Proceedings, Seminar on Precast Concrete Construction in Seismic Zones, JSPS/NSF, Tokyo, 1989, Vol. I, pp. 127-142.

Nakaki, S. D., and R. E. Englekirk. 1991. "PRESS Industry Seismic Workshops: Concept Development," *PCI Journal* 36(5):54-61.

Neille, D. S. 1977. Behavior of Headed Stud Connections for Precast Concrete Connections for Precast Concrete Panels Under Monotonic and Cycled Shear Loading, thesis submitted in partial fulfillment of the requirements of Doctor of Philosophy, University of British Columbia.

New Zealand Society of Earthquake Engineering. 1991. Guidelines for the Use of Structural Precast Concrete in Buildings.

Pekau, O. A., and D. Hum. 1991. "Seismic Response of Friction-Jointed Precast Panel Shear Walls," *PCI Journal* 36(2):56-71.

Powell, G., F. Filippou, V. Prakash, and S. Campbell. 1993. "Analytical Platform for Precast Structural Systems." In Proceedings, ASCE Structures Congress '93. New York: ASCE.

Priestley, M. J. N. 1991. "Overview of PRESS Research Program," *PCI Journal* 36(4):50-57.

Priestley, M. J. N., and J. R. Tao. 1991. "Seismic Response of Precast-Prestressed Frames with Partially Debonded Tendons," Second Meeting of US-Japan Joint Technical Coordinating Committee for PRESS, Tsukuba, Japan, November.

Stanton, J. F., R. G. Anderson, C. W. Dolan, and D. E. McClearly. 1986. Moment-Resisting and Simple Connections, Research Report 1/4, Prestressed Concrete Institute.

Warnes, C. E. 1992. "Precast Concrete Connection Details for All Seismic Zones," *Concrete International* 14(11):36-44.

Wood, S. L. 1990. "Shear Strength of Low-Rise Reinforced Concrete Walls," *ACI Structural Journal* 87(1):99-107.

Yee, A. A. 1991. "Design Considerations for Precast Prestressed Concrete Building Structures in Seismic Areas," *PCI Journal* 36(3):40-55.

### **Prestressed and Partially Prestressed Concrete**

ACI-ASCE Committee 423. 1985. "Recommendations for Concrete Members Prestressed with Unbonded Tendons," *ACI Manual for Concrete Practice, Part 3*, p. 423.3-1 - 423.3-R16. Detroit, Michigan: American Concrete Institute.

Hirosawa, M., M. Ozaki, and M. Wakabayashi. 1973. "Experimental Study on Large Models of Reinforced Concrete Columns." In Proceedings of the Fifth World Conference on Earthquake Engineering, Rome.

Ishizuka, T., and N. M. Hawkins. 1987. Effect of Bond Deterioration on the Seismic Response of Reinforced and Partially Prestressed Concrete and Ductile Moment Resistant Frames, Report SM 87-2. Seattle: University of Washington, Department of Civil Engineering.

JSPS/NSF. 1986. Proceedings of the Seminar on Precast Construction in Seismic Zones, Vol. 1.

Ma, S. M., V. V. Bertero, and E. P. Popov. 1976. Experimental and Analytical Studies on the Hysteretic Behavior of Reinforced Concrete Rectangular and T-Beams, Report EERC 72-2. Berkeley: University of California.

Park, R., and K. J. Thompson. 1977. "Cyclic Load Tests on Prestressed and Partially Prestressed Beam-Column Joints," *PCI Journal* 22(5):84-110.

Paulay, T. 1977. "Capacity Design of Reinforced Concrete Ductile Frames." In *Proceedings of the Workshop on ERCBC*, University of California.

Paulay, T., and J. R. Binney. 1974. "Diagonally Reinforced Coupling Beams of Shear Walls." In *Shear in Reinforcement Concrete*, Vol. 2, Publication SP-42, pp. 579-598. Detroit, Michigan: American Concrete Institute.

Scribner, C. F., and J. K. Wight. 1978. *Delaying Shear Strength Decay in Reinforced Concrete Flexural Members Under Large Load Reversals*, University of Michigan, Department of Civil Engineering Report UMEE 78R2 to the National Science Foundation.

Shiu, K. N., G. B. Barney, A. E. Fiorato, and W. G. Corley. 1978. "Reversing Load Tests of Reinforced Concrete Coupling Beams." In *Proceedings of the Central American Conference on Earthquake Engineering*, San Salvador.

Thompson, K. J., and R. Park. 1980. "Seismic Response of Partially Prestressed Concrete," *ASCE Journal of the Structural Division* 106(ST8):1755-1775.



## Appendix to Chapter 9

### REINFORCED CONCRETE STRUCTURAL SYSTEMS

#### COMPOSED OF INTERCONNECTED PRECAST ELEMENTS

**PREFACE:** The provisions for reinforced concrete structural systems composed of precast elements in the body of the 1997 Provisions are for precast systems emulating monolithic reinforced concrete construction. However, one of the principal characteristics of precast systems is that they often are assembled using dry joints where connections are made by bolting, welding, post-tensioning, or other similar means. Research conducted to date documents concepts for design using dry joints and the behavior of subassemblages composed from interconnected precast elements both at and beyond peak strength levels for nonlinear reversed cyclic loadings (Applied Technology Council, 1981; Cheok and Lew, 1992; Clough, 1986; Elliott et al., 1987; Hawkins and Englekirk, 1987; Jayashanker and French, 1988; Mast, 1992; Nakaki and Englekirk, 1991; Neille, 1977; New Zealand Society, 1991; Pekau and Hum, 1991; Powell et al., 1993; Priestley, 1991; Priestley and Tao, 1992; Stanton et al., 1986; Stanton et al., 1991). This appendix is included for information and as a compilation of the current understanding of the performance under seismic loads of structural systems composed from interconnected precast elements. It is considered premature to base code provisions on this resource appendix; however, user review, trial designs, and comment on this appendix are encouraged. Please direct such feedback to the BSSC.

The only design approach currently validated adequately for codification for construction using precast elements is that of emulation of monolithic reinforced concrete construction. Yet, in regions of moderate and low seismicity, it is reasonable to expect that structural systems of adequate strength, stiffness, and energy dissipation can be constructed from precast concrete elements using bolting, welding, or similar means that involve dry connections only. The objective of this appendix is to provide a framework within which such systems can begin to be codified for design purposes.

Tests by Stanton et al. (1986) have demonstrated that many of the moment resisting dry connections typically utilized for precast concrete construction for gravity loadings have adequate behavior for monotonic but not reversed loading. For reversed loadings, such connections lack ductility whenever the connection is made by welding or bolting. For example, as illustrated in Figure C9A-1, the corbel connection shown in (a) functions well for gravity loadings (b) but not for loading reversals (c) through (f). In the latter case, the corbel is an impediment to ductility because the connection is not detailed carefully enough. For negative moment loading, the beam

end rotates about the edge of the corbel causing a prying action on the negative moment connection to the column and marked secondary stresses in the reinforcement, inserts, or welds that make up that connection. The prying causes kinking of the reinforcement initiating spalling or splitting of the concrete surrounding that reinforcement. That action, combined with splitting of the beam end or the corbel edge for positive moment loadings, results in the strength rapidly dropping below acceptable levels with load reversals and increasing rotations. However, that does not mean that all corbels per se are bad for reversed loadings. Shown in Figure C9A-2 is an inverted T-beam detail that has been developed to provide positive connection to the corbel while minimizing difficulties associated with beam shrinkage and beam loading reversals.

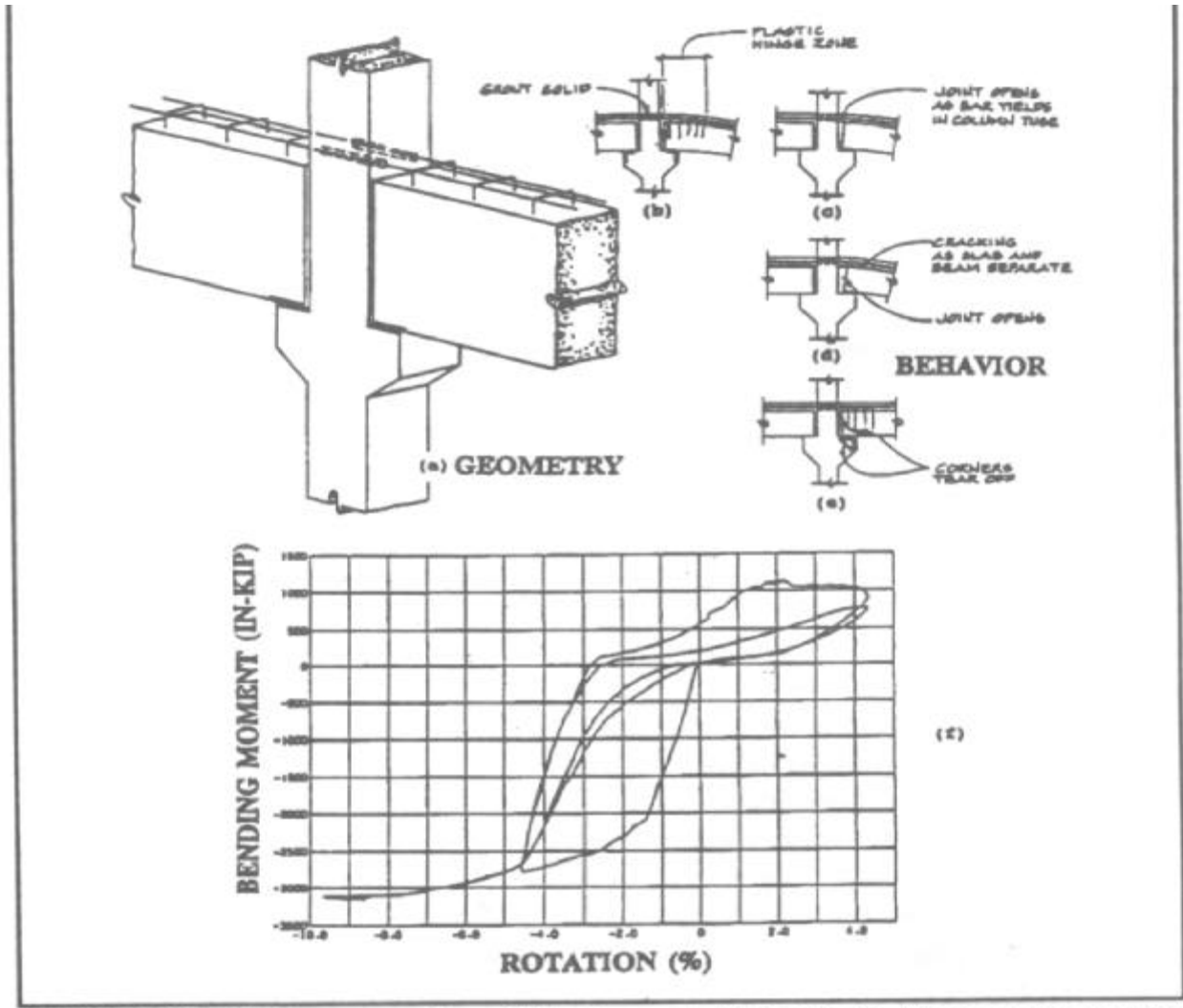
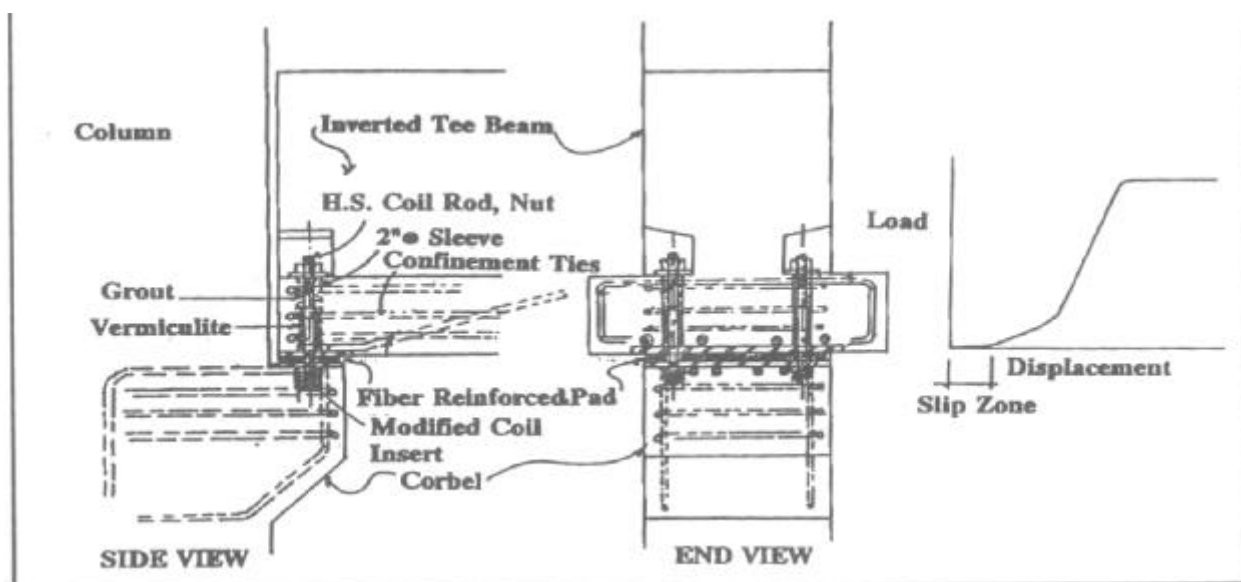

Figure C9A-1 Dry connections (PCI Research Project/4-86, Moment Connection BC16A).



**Figure C9A-2 Inverted tee beam to corbel connection (Shockey Bros., Winchester, Virginia).**

It is essential that connection detailing recognize the load-deformation behavior imposed on connections by requirements of the seismic force resisting structural system selected and possible uncertainties in the connection's response. Ideally, appropriate detailing concepts should be developed through analytical modeling and verified by physical testing. Without physical testing, the uncertainties in the response make it imperative that the response modification coefficients and deflection amplification factors used for lateral-force-resisting systems constructed with dry connections be less than those for the comparable monolithic reinforced concrete structural systems. However, regardless of the  $R$  and  $C_d$  values used it is essential to identify:

1. The magnitude of the deformation demands to which each connection will be subjected in order for the structural system to achieve the overall deformation required of it;
2. The ability of each connection to provide that deformation and the associated probable strength without failure; and
3. The ability of each connection and the associated connection region to provide the necessary system stiffness and energy dissipation.

Sec. 9A.2 addresses identification of the relation between the deformation demand imposed on the connections, their deformation capacity, and the deformation demands, ( $R$  and  $C_d$ ) selected for the structure. The designer is required to study those relationships and identify the potential for prying actions or undesirable rocking motions. Use of computer programs, such as Drain-2DX developed by Powell et al. (1993), usually will be necessary to study the relation between the deformation selected for the structure and the resultant deformation demands placed on the connections.

Sec. 9A.3 addresses limitations on the  $R$  and  $C_d$  factors that can be used for the lateral-force-resisting structural framing system. Values as large as those for monolithic construction can be used if the connection's response characteristics have been established by physical testing. If, however, those characteristics have been determined only through analytical modeling, values are required to be less than those for monolithic construction because of uncertainties about response of the actual connections.

For Table 9A.3.3, it is intended that the values selected for  $R_j$  and  $C_{dj}$  should have the same relation to one another as the values specified for  $R$  and  $C_d$  in Table 2.2.2. For example, for a special moment frame of reinforced concrete,  $R$  and  $C_d$  are specified in Table 2.2.2 as 8 and 5.5, respectively. For the same frame, connections of Category C are required by this appendix. Thus, by Table 9A.3.3,  $R_j$  can range for the precast frame from 4 to 7 and  $C_{dj}$  can range from 2.25 to 4.5. The footnote to Table 9A.3.3 requires that  $R_j$  and  $C_{dj}$  be varied in step so that the designer can choose, depending on the detailing practice used,  $R_j$  and  $C_{dj}$  values coupled as shown in Table C9A.3.3.

**TABLE C9A.3.3 Restricted  $R$  and  $C_d$  for Connection Category C**

<b>Restricted Response Modification Coefficient, <math>R_j</math></b>	<b>Restricted Deflection Amplification Factor, <math>C_{dj}</math></b>
4	2.25
5	3.00
6	3.75
7	4.5

Sec. 9A.4 provides a framework for evaluating connection performance. The connection is identified as having three factors contributing to its characterization: the connector, its anchorage, and the surrounding connection region. Three Connection Performance Categories are identified. For Connection Performance Category A, there are no special requirements but those connections can be used only for lateral-force-resisting systems of Seismic Design Category A. Further, any dry connection for which there is not direct transfer of tensile or shear force from the connector's anchorage to the principal reinforcement of the precast element by welding, bolting, or adequate lap length must be assigned to Category A. Performance Category B connections must exhibit stable inelastic capacities with increasing reversed cyclic deformation demands. However, such connections do not have to have the energy dissipation hysteretic characteristics normally associated with monolithic concrete connections. For example, the connection illustrated in Figure C9A-3 has a satisfactory performance for a probable strength of 180 kips and a reversed deformation of 10 mm. A connection cannot be used for lateral-force-resisting systems of Seismic Design Category C, D, or E unless that connection is of Connection Performance Category C for which the stressed area at the interface must be greater than 30 percent of that for the closest adjacent area of uniform stress in the precast element. This



restriction is aimed at minimizing the concentration of inelastic deformations in the element by forcing connections to be designed so as to activate a significant volume of the adjacent precast element and, therefore, more closely replicate the behavior for monolithic reinforced concrete construction.

The majority of the requirements of this appendix are intended to apply to precast elements and nonlinear action location connections that are part of the lateral force resisting system. However, Sec. 9A.5.2 also addresses the special case where there is a connector that is on the lateral-load-resisting path and is not to be part of the nonlinear action response. Further, it is also very important to consider the integrity and flexibility of all other connections in the structure to determine that their behavior is compatible with the anticipated lateral movements of the building.

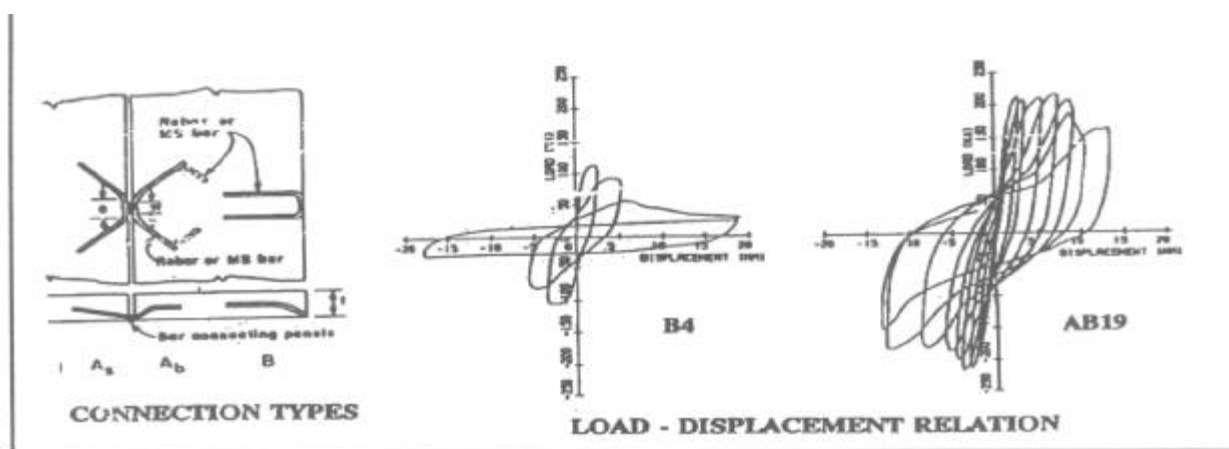

Figure C9A-3 Dry connections (R.Spencer, Earthquake Resistance Connections for Low Rise Precast Concrete Buildings, JSPS Seminar on Precast Concrete Construction in Seismic Design).

## REFERENCES

- Applied Technology Council. 1981. Proceedings of a Workshop on Design of Prefabricated Concrete Buildings for Earthquake Loads, Report ATC-8.
- Cheok, G. S., and H. S. Lew. 1991. "Performance of Precast Concrete Beam-to-Column Connections Subject to Cyclic Loading," PCI Journal 36 (3):56-67.
- Clough, D. P. 1986. "A Seismic Design Methodology for Medium-Rise Precast Concrete Buildings." In Proceedings of Seminar on Precast Construction in Seismic Zones, JSPS/NSF, Tokyo, October.
- Elliott, K. S., et al. 1987.
- Hawkins, N. M., and R. E. Englekirk. 1987. "U.S.-Japan Seminar on P/C Concrete Construction in Seismic Zones," PCI Journal 32(2).
- Jayashanker, V., and C. E. French. 1988. An Interior Moment Resistant Connection Between

Precast Elements Subjected to Cyclic Lateral Loads, Structural Engineering Report 87-10. Minneapolis: University of Minnesota.

Mast, R. F. 1992. "A Precast Concrete Frame System for Seismic Zone Four," *PCI Journal* 37(1):50-64.

Nakaki, S. D., and R. E. Englekirk. 1991. "PRESS Industry Seismic Workshops: Concept Development," *PCI Journal* 36(5):54-61.

Neille, D. S. 1977. Behavior of Headed Stud Connections for Precast Concrete Connections for Precast Concrete Panels Under Monotonic and Cycled Shear Loading, thesis submitted in partial fulfillment of the requirements of Doctor of Philosophy, University of British Columbia.

New Zealand Society of Earthquake Engineering. 1991. Guidelines for the Use of Structural Precast Concrete in Buildings.

Pekau, O. A., and D. Hum. 1991. "Seismic Response of Friction-Jointed Precast Panel Shear Walls," *PCI Journal* 36(2):56-71.

Powell, G., F. Filippou, V. Prakash, and S. Campbell. 1993. "Analytical Platform for Precast Structural Systems." In Proceedings, ASCE Structures Congress '93. New York: ASCE.

Priestley, M. J. N. 1991. "Overview of PRESS Research Program," *PCI Journal* 36(4):50-57.

Priestley, M. J. N., and J. R. Tao. 1992.

Stanton, J. F., R. G. Anderson, C. W. Dolan, and D. E. McClearly. 1986. Moment-Resisting and Simple Connections, Research Report 1/4, Prestressed Concrete Institute.

Stanton, J. F., T. R. Hicks, and N. M. Hawkins. 1991. PRESSS Project 1.3: Connection Classification and Evaluation. *PCI Journal* 36(5):62-71.

## Chapter 10 Commentary

### COMPOSITE STEEL AND CONCRETE STRUCTURE DESIGN REQUIREMENTS

The 1994 Edition of the *NEHRP Recommended Provisions* included a new chapter on composite steel and concrete structures. These provisions have been updated and incorporated in Part II of the 1997 Edition of the *AISC Seismic Provisions*. This edition of the *NEHRP Recommended Provisions* includes by reference Part II of the *AISC Seismic Provisions (1997)*, together with the underlying *AISC-LRFD (1993)* and *ACI-318 (1995)* standards. Part II of the *AISC Seismic Provisions* provides definitions for composite systems consistent with the system designations in Table 5.2.2 and specifies requirements for the seismic design of composite systems and components.

In general, available research shows that properly detailed composite elements and connections can perform as well, or better, than structural steel and reinforced concrete components. However, due to the lack of design experience with certain types of composite *structures* in high seismic risk areas, usage of composite systems in *Seismic Design Categories D* and above requires documentation (substantiating evidence) that the proposed system will perform as intended by Part II of the *AISC Seismic Provisions* and implied by the *R* values in Table 5.2.2. It is intended that the substantiating evidence consist of a rational analysis that considers force transfer between structural steel, reinforced concrete and composite elements and identifies locations in the *structure* required to sustain inelastic deformations and dissipate seismic energy. Design of composite members and connections to sustain inelastic deformations shall be based on models and criteria substantiated by test data. For many composite components, test data and design models are available and referenced in the commentary to the *AISC Seismic Provisions – Part II (1997)*.

## Chapter 11 Commentary

### MASONRY STRUCTURE DESIGN REQUIREMENTS

#### 11.1 GENERAL:

**11.1.1 Scope:** The provisions of Chapter 11 govern design and construction of all types of masonry. Quality assurance is covered with a reference to Chapter 3. Reinforced and plain (unreinforced) masonry elements that are part of the basic structural system and those that are not part of the basic structural system are included.

**11.1.2 Reference Documents:** Design and construction standards cited in Chapter 11 are listed in Sec. 11.1.2. The materials standards are specifically listed to include only those materials permitted by the provisions. The listing includes the document's designation, the year of the edition and the title of the document.

**11.1.3 Definitions:** Terms used in the provisions which have a specific meaning which differs from the dictionary definition are defined in Sec. 11.1.3. All other terms are defined by the dictionary.

**11.1.4 Notations:** Notations used in the provisions are defined in Sec. 11.1.4. English units of measure are stated followed by the metric unit in parenthesis for each term.

#### 11.2 CONSTRUCTION REQUIREMENTS:

**11.2.1 General:** Ref. 11-2 is a standard specification prepared under consensus procedures. It was developed by members representing construction, design, materials, and research of masonry structures. The document is intended to be incorporated into contract documents used to construct masonry structures.

This standard specification was developed to be used in conjunction with *Building Code Requirements for Masonry structures*, Ref. 11-1. Appropriate standards for materials and test methods are referenced. In addition to a general section, there are sections on masonry, reinforcement and metal accessories, and grout.

The materials listed in Ref. 11-2 have been restricted in order to obtain more predictable behavior and better performance required for strength design. Construction provisions found in Chapter 11 override those found in Ref. 11-2.

**11.2.2 Quality Assurance:** See Chapter 3 of the *Provisions and Commentary*. Quality assurance requirements for masonry structures include testing of masonry *components* (mortar, grout, and units) or testing of masonry assemblages. Industry guidelines for materials testing are listed below.

1. Brick Institute of America, 11490 Commerce Park Drive, Reston, Virginia 22091, *Technical Notes on Brick Construction*:

No. 39 Revised, "Testing for Engineered Brick Masonry: Brick, Mortar and Grout," January 1987.

No. 39A, "Testing for Engineered Brick Masonry: Determination of Allowable Design Stresses," December 1987.

No. 39B, "Testing for Engineering Brick Masonry: Quality Assurance," March 1988.

2. National Concrete Masonry Association, 2302 Horse Pen Road, Herndon, Virginia 22071-3499:  
TEK 22A, *Prism Testing for Engineered Concrete Masonry*, 1979.  
TEK 107, *Laboratory and Field Testing of Mortar and Grout*, 1979.  
TEK 108, *Testing Concrete Masonry Assemblages*, 1979.

Industry guidelines for field inspection are listed below.

1. Brick Institute of America, 11490 Commerce Park Drive, Reston, Virginia 22091, *Technical Notes on Brick Construction*:  
No. 17C, "Reinforced Brick Masonry: Inspectors' Guide," May 1986.
2. National Concrete Masonry Association, 2302 Horse Pen Road, Herndon, Virginia 22071-3499:  
TEK 65, *Field Inspection of Engineered Concrete Masonry*, 1975.  
TEK 132, *Inspector's Guide for Concrete Masonry Construction*, 1983.

### **11.3 GENERAL DESIGN REQUIREMENTS:**

**11.3.1 Scope:** This chapter offers three different methods for designing masonry structures. Any method, used within the limitations imposed, provides acceptable masonry construction with acceptable seismic resistance characteristics.

**11.3.2 Empirical Masonry Design:** Empirical design methods are based on the successful performance of masonry buildings. Prescriptive requirements and limited exposure to loads are necessary to ensure compliance.

The design process results in sizes and proportions of masonry elements using minimum thicknesses and maximum spans. Although rudimentary stress calculations are made, empirical masonry design does not require a complete structural analysis.

**11.3.3 Plain (Unreinforced) Masonry Design:** Design methods for plain masonry, often referred to as unreinforced masonry. The procedures utilize working stress design requirements using principles of mechanics.

**11.3.4 Reinforced Masonry Design:** Reinforcing steel complements the high compressive strength of masonry with high tensile strength. Increased load-carrying capacity and greater ductility result from the use of reinforcing steel.

**11.3.5 - 11.3.9 Seismic Design Categories A through F:** Any type of masonry shear wall is permitted in Seismic Design Categories A and B. Detailed plain masonry shear walls or intermediate reinforced masonry shear walls are required for Seismic Design Category C. Special reinforced masonry shear walls are required for Seismic Design Categories D, E, or F. Minimum requirements for each type of masonry shear wall are given in Sec. 11.11. These requirements are consistent with intended inelastic deformation capacities that are the bases for the  $R$ ,  $\Omega$ , and  $C_d$  factors given in Table 5.2.2. Additional requirements for construction of masonry elements other than shear walls are given for each Seismic Design Category in Sec. 11.3.5 through 11.3.9

**11.3.6 Seismic Design Category B:** The use of empirical masonry design, Sec. 11.3.2, for the lateral load resisting system is not appropriate for Seismic Design Category B. Masonry walls that are not part of the lateral load resisting system may be designed by the empirical method.

**11.3.10: Properties of Materials:**

**11.3.10.1 Steel Reinforcement Modulus of Elasticity:** The given modulus of elasticity of steel reinforcement is taken from previous codes and is consistent with established design values. Design may be based on tested values of modulus of elasticity; however, these tests are rarely performed because it is impractical to test materials to be used in the construction at the time when the project is being designed.

**11.3.10.2 Masonry Modulus of Elasticity:** Modulus of elasticity of masonry is used in determining stiffness of structural components prior to cracking. Therefore, the modulus is taken from the elastic portion of the stress strain curve. The modulus of elasticity of masonry is not clearly related to any property of mortar, unit, grout or prism  $h/t$ , but is influenced by all of these. TS5 concluded it was best to relate the value of  $E_m$  to the specified compressive strength of masonry. This is because  $f'_m$  is also influenced by these parameters. The 750 multiplier is used rather than lower multipliers reported (Wolde-Tinsae, 1993) since the actual compressive strength of masonry must exceed the specified compressive strength.

**11.3.10.4 Masonry Compressive Strength:** Research has been performed on structural masonry components having a compressive strength in the range of 1,500 to 6,000 psi (10 to 41 MPa). Design criteria are based on these research results. Design values therefore are limited to compressive strengths in the range of 1,500 to 4,000 psi (10 to 28 MPa) for concrete masonry and 1,500 to 6,000 psi (10 to 41 MPa) for clay masonry.

**11.3.10.5 Modulus of Rupture:** Modulus of rupture values in Table 11.3.10 are based on allowable working stress values for flexural tension multiplied by 2.0 to approximate the lower limit of strength values. See the Commentary to Ref. 11-1 for discussion. Stack bond masonry has historically been assumed to have no flexural bond strength across the head joints; thus, the grout area alone is used.

**11.3.10.6 Reinforcement Strength:** Research conducted on reinforced masonry components used Grade 60 reinforcement. To be consistent with laboratory documented performance, design is based on a steel yield strength that does not exceed 60,000 psi (413 MPa).

**11.3.11 Section Properties:** Section properties of masonry members are available in masonry design publications. Design is based on specified dimension. Actual dimensions may vary within the tolerance range given in the construction requirement (i.e., Ref. 11-2). The strength reduction factors are based in part on an anticipated variation in the specified (design) dimensions.

**11.3.12 Headed and Bent-Bar Anchor Bolts:** This section covers cast-in-place headed anchor bolts and bent-bar anchors (J- or L-bolts) in grout. General background information on this topic is given in CEB, 1995.

The tensile capacity of a headed anchor bolt is governed by yield and fracture of the anchor steel or by breakout of a roughly conical volume of masonry starting at the anchor head and having a fracture surface oriented at 45 degrees to the masonry surface. Steel capacity is calculated conventionally using the effective tensile stress area of the anchor (i.e., including the reduction in area of the anchor shank due to threads). Masonry breakout capacity is calculated using expressions adapted from concrete design, which use a simplified design model based on a stress of  $4\sqrt{f_m}$ , uniformly distributed over the area of that right circular cone, projected onto the surface of the masonry. Reductions in breakout capacity due to nearby edges or adjacent anchors are computed in terms of reductions in those projected areas (Brown and Whitlock, 1983).

The tensile capacity of a bent-bar anchor bolt (J- or L-bolt) is governed by yield and fracture of the anchor steel, by tensile cone breakout of the masonry, or by straightening and pullout of the anchor from the masonry. Capacities corresponding to the first two failure modes are calculated as for headed anchor bolts. Pullout capacity is calculated as proposed by Shaikh, 1996. Possible contributions to tensile pullout capacity due to friction are neglected.

The tensile breakout capacity of a headed anchor is usually much greater than the pullout capacity of a J- or L-bolt. the designer is encouraged to use headed anchors when anchor tensile capacity is critical.

The shear capacity of a headed or a bent-bar anchor bolt is governed by yield and fracture of the anchor steel or by masonry shear breakout. Steel capacity is calculated conventionally using the effective tensile stress area (i.e., threads are conservatively assumed to lie in the critical shear plane). Shear breakout capacity is calculated as proposed ;by Brown and Whitlock, 1983.

Under static shear loading, bent-bar anchor bolts (J- or L-bolts) do not exhibit straightening and pullout. Under reversed cyclic shear, however, available research suggests that straightening and pullout may occur. Headed anchor bolts are recommended for such applications (Malik et al., 1982).

## **11.5 STRENGTH AND DEFORMATION REQUIREMENTS:**

**11.5.3 Design Strength:** The design strength of a member and its connections is calculated by engineering principles and materials strength and yield values. This calculated strength is the nominal strength of the member. The nominal strength is less than the expected or mean strength because minimum guaranteed values or specified strengths are used for the calculations of nominal strength. A strength reduction factor,  $\phi$ , is used to reduce the nominal strength to a design strength. The strength reduction factor,  $\phi$ , is a variable that is dependent on the material and material behavior. Flexural strength of reinforced members is reduced less by the  $\phi$  factor than is shear strength. Exceeding of the flexural strength of a reinforced member causes yielding of the reinforcement but not strength degradation. Exceeding of the shear strength results in a strength degradation.

**Flexure Without Axial Load:** The strength reduction factor for reinforced masonry is greater than for plain masonry because plain masonry after cracking lacks ductile performance.

**Axial Load and Axial Load with Flexure:** If the axial load results in balanced strain conditions (flexure produces strain in the reinforcement equal to the yield strain and strain in the masonry equal to the maximum usable strain,  $\epsilon_{mu}$ ) and the flexural reinforcement is minimal, an increase in flexural moment can cause compressive stresses in excess of the compressive strength. The failure will not be ductile; therefore, the strength reduction factor is more severe. Linear interpolation of the strength reduction factor is allowed since the required axial strength due to factored load,  $P_u$ , decreases from the axial load resulting in balanced strain conditions to zero, so as to make the transition linear from axial load with flexure to flexure without axial load.

The strength reduction factor for the vertical members of wall frames is more restrictive than for shear walls or coupled shear walls. The strength reduction factor for the vertical members of wall frames does not have a linear variation to its value. When  $P_u/A_s f'_m$  is equal to 0.1, the strength reduction factor will be equal to 0.65.

The strength reduction factor for plain masonry members is unchanged from that factor that is applied for flexure only. Axial load increases the flexural capacity of plain masonry but does not significantly change its lack of ductility.

**Shear:** Strength reduction factors for calculation of design shear strength are commonly more severe than those factors used for calculation of design flexural strength. This concept is partially supported by the wider variance of shear capacities that have been obtained from experimental testing. The variance of the results of each experiment from the body of data is due not only to the variability of the masonry materials, the test apparatus and test methods, and the shear strength parameters tested but also to the greater sensitivity of shear resistance mechanisms to those factors.

**Bearing:** Exceeding of the bearing capacity causes crushing and spalling of bearing surfaces. The strength reduction factors given are those established for elements that have strength degradation.

**11.5.4 Deformation Requirements:** Stiffness of a structural element is as important or more important than strength. Stiffness is critical for serviceability and control of displacements. Drift of an element is the movement of one story of the building relative to the adjacent stories or the displacement of the shear wall relative to its fixed base. Drift of the top level of a shear wall is affected by foundation flexibility but the structural stresses and strains in the wall would not be increased by foundation flexibility.

The product of the effective moment of inertia,  $I$ , and the effective modulus of elasticity,  $E$ , is usually used as a variable for the calculation of the deformation of reinforced elements. The variability in  $I$  is caused by tensile cracking of the masonry cross section. If tensile cracking is not acceptable, as for plain masonry,  $I$  has a single value and the compressive modulus of elasticity and the moment of inertia of the gross cross section is used for the calculation of deformation.

If tensile cracking is anticipated, such as for reinforced masonry, the effective  $I$  at every cross section of the wall or beam is dependent on the curvature of the cross section and the shear deformation of each increment of the member length. Several nonlinear finite element programs have the capability of determining the stiffness degradation of reinforced masonry elements, but the effective stiffness,  $I$ , can be determined by use of Eq. 11.5.4.3.



The cracking moment is calculated using the section modulus of the gross section of wall times the modulus of rupture of masonry,  $f_r$ . The moment of inertia of the cracked section is calculated about the neutral axis of the section, using the masonry properties, and transforming the reinforcement into equivalent masonry areas by use of the ratio of the compressive modulus of steel and masonry. The cracked moment of inertia,  $I_{cr}$ , and the compressive modulus of masonry,  $E_m$ , is used to calculate the effective moment of inertia,  $I_{eff}$ .

Eq. 11.5.4.3 has been used as a means of providing a transition in stiffness between gross moment of inertia and a totally cracked section. Abboud (1987), Abboud and Hamid (1987), Abboud et al. (1990 and 1993), Hamid et al. (1989), and Horton and Tadros (1990) give additional insight and behavior for computing deflection for masonry components.

## 11.6 FLEXURE AND AXIAL LOADS:

**11.6.2 Design Requirements of Reinforced Masonry Members:** The design principles listed are those that traditionally have been used for reinforced masonry members. The theory used for design of normally proportioned flexural members has limited applicability to deep flexural members. Shear warping of the cross section and a combination of diagonal tension stress and flexural tension stresses in the body of the deep flexural members require that deep beam theory be used for members that exceed the specified limits of span to depth ratio.

**11.6.2.2:** Longitudinal reinforcement in flexural members is limited to a maximum amount to ensure that masonry compressive strains will not exceed ultimate values. For all masonry components other than walls bending in the out-of-plane sense, maximum reinforcement is limited in accordance with a prescribed strain distribution based on a tensile strain equal to five times the yield strain for the reinforcing bar closest to the edge of the member, and a maximum masonry compressive strain equal to 0.0025 for concrete masonry or 0.0035 for clay-unit masonry. By limiting longitudinal reinforcement in this manner, inelastic curvature capacity is easily depicted as the slope of this strain distribution.

Because axial force is implicitly considered in the determination of maximum longitudinal reinforcement, inelastic curvature capacity can be relied on no matter what the level of axial compressive force. Thus, the capacity reduction factors,  $\phi$ , for axial load and flexure can be the same as for flexure alone. Also, confinement reinforcement is not required because the maximum masonry compressive strain will be less than ultimate values.

Calculated tensile force in the reinforcement is based on a stress equal to 1.25 times the yield stress to account for differences between the actual yield strength and the minimum specified strength, and the possibility of strain hardening. This increase of stress beyond yield also compensates for effects of discontinuous tensile strain fields that develop as a result of tensile cracking.

The masonry compressive force is estimated using a rectangular stress block defined with parameters based on recent research done with the Technical Coordination Committee for Masonry Research (TCCMaR).

For walls bending out-of-plane, the limit on maximum reinforcement is relaxed by considering a strain distribution based on 1.3 times the yield strain for the reinforcing bar closest to the member edge. This limiting strain distribution is less severe than that adopted for in-plane bending. It is based on research done by Blondet and Mayes (1991).

Maximum reinforcement per the requirements of Sec. 11.6.2.2.1 for an in-plane wall with uniformly distributed vertical reinforcement can be derived using simple equilibrium concepts to give:

$$\rho_{\max} = \frac{0.64f'_m \alpha - \frac{P_g}{bd}}{1.25f_y(1 - \alpha) - 0.5f_{s \max} \alpha} \quad (\text{C11.6.2.2-1})$$

where  $\rho_{\max}$  is the total amount of vertical steel divided by  $b$  and  $d$ ;  $b$  is the width of the section;  $d$  is the distance from the extreme compressive fiber to the location of the tensile vertical bar closest to the edge of the member;  $\alpha$  is equal to the depth of the compression zone divided by the effective depth,  $d$ ;  $P_g$  is equal to the unfactored gravity compressive force;  $f_y$  is the specified yield stress of the reinforcement, and  $f_{s \max}$  is the maximum compressive stress in the vertical reinforcement.

Similarly, maximum reinforcement per the requirements of Sec. 11.6.2.2.2 for an out-of-plane wall with a single layer of vertical reinforcement centered on the wall section reduces to:

$$\rho_{\max} = \frac{0.64f'_m \alpha - \frac{P_g}{bd}}{2.50f_y} \quad (\text{C11.6.2.2-2})$$

where  $\rho_{g \max}$  is the total amount of vertical steel divided by the gross area of the wall section.

Maximum percentages of reinforcement as given by Equations C11.6.2.2-1 and C11.6.2.2-2 are plotted versus vertical compressive stress in Figures C11.6.2.2-1 and C11.6.2.2-2 for clay-unit and concrete masonry of typical compressive strengths (3000 psi for clay-unit masonry and 2000 psi for concrete masonry). For in-plane walls, average vertical compressive stress across the section is taken to be the same as  $P_g/bd$  since the distance  $d$  is close to the total section depth. Maximum reinforcement is limited by out-of-plane criteria for lower vertical axial compressive stresses and by in-plane criteria for higher axial stresses.

For calibration purposes, maximum longitudinal reinforcement per Sec. 2108.2.3.3 of the 1997 Uniform Building Code is also plotted in Figures C11.6.2.2-1 and C11.6.2.2-2. The *UBC* criterion limits longitudinal reinforcement to no more than one-half of that resulting in a balanced condition where ultimate masonry compressive stress is equal to 0.003 and reinforcement is at its yield strain. A rectangular stress block is to be used with a stress equal to 0.85 times  $f'_m$  and a stress block depth equal to 0.85 times the compressed zone. No increase in the yield stress is specified by the *UBC* to account for increases due to higher expected strengths, strain hardening, or flexural cracking. The *UBC* criterion also considers axial force when limiting maximum reinforcement. However, in addition to

gravity forces, axial forces due to earthquake effects times a load factor of 1.4 are also considered. Using the same procedure as used to derive the two former equations, the *UBC* criterion reduces to:

$$\rho_{g \text{ max}} = \frac{1}{2} \left[ \frac{0.723 f'_m \alpha - \frac{P_u}{bd}}{2.00 f_y} \right] \quad (\text{C11.6.2.2-3})$$

where  $P_u$  is the factored axial load ( $1.0D + 1.0L + 1.4E$ ).

The *UBC* criterion results in a more restrictive limit on maximum reinforcement for axial compressive stress less than 381 psi for clay-unit masonry and 103 psi for concrete masonry (with the assumed values of  $f'_m$ ). For axial compressive stresses above these values, the in-plane criterion per Sec. 11.6.2.2 results in a more restrictive limit on maximum reinforcement.

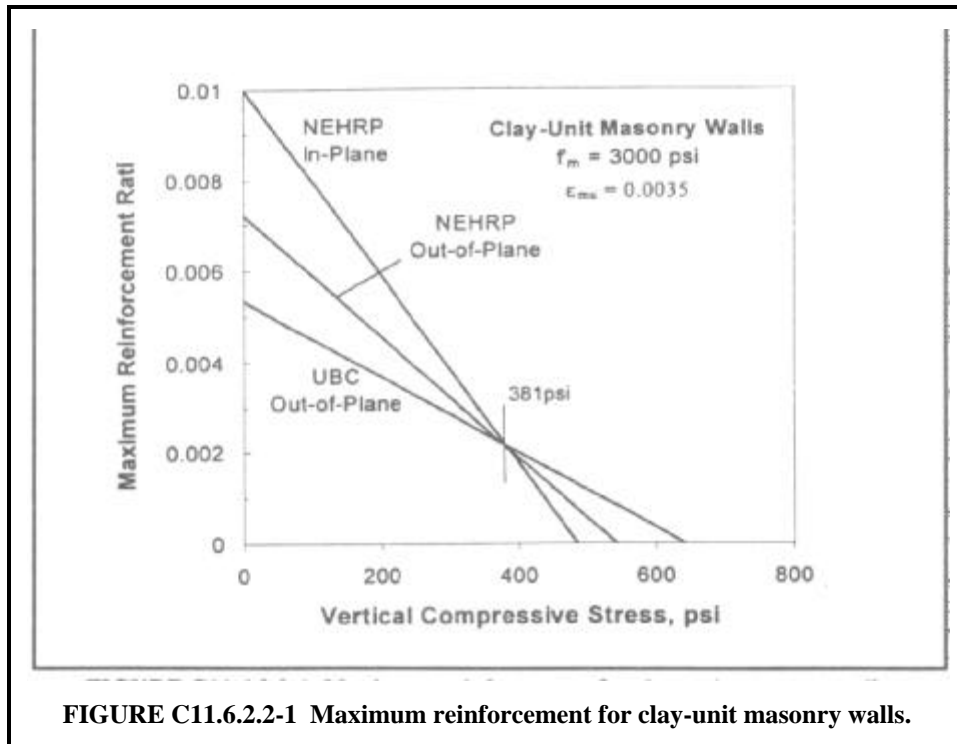

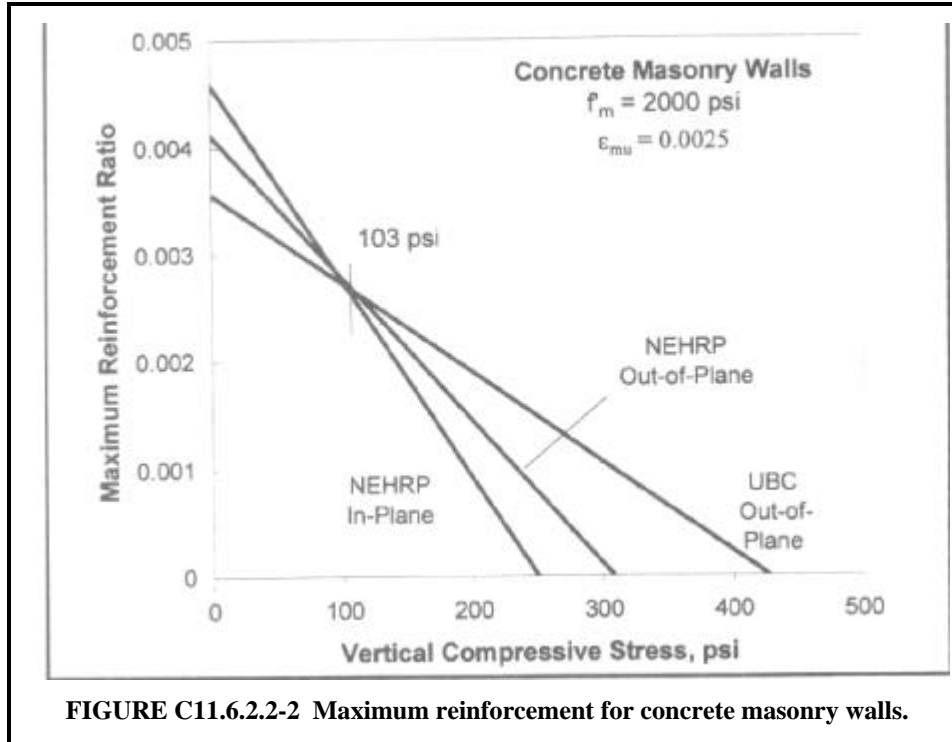

For further discussion, see He and Priestley (1992), Leiva and Klingner (1991), Limin and Priestley (1988), Merryman et al. (1989), Seible et al. (1992), and Shing et al. (1991).

### 11.6.3 Design of Plan (Unreinforced) Masonry Members:

**11.6.3.5:** The axial load strengths given by Eq. 11.6.3.5-1 and 11.6.3.5-2 are based on analysis of the results of axial load tests performed on clay and concrete masonry elements. For members having an  $h/r$  ratio not exceeding 99, the specimens failed at loads less than the Euler buckling load. Eq. 11.6.3.5-1 was empirically fit to test data for these members. For  $h/r$  values in excess of 99, the limited test data is adequately approximated by the Euler buckling equation.

## 11.7 SHEAR:

**11.7.3 Design of Reinforced Masonry Members:** The development of strength design procedures for masonry requires a reasonably simplified and accurate equation that is capable of predicting the ultimate shear strength of a masonry wall. Once agreed upon, this equation, together with appropriate  $\phi$  factors, will form a key part of strength design procedures.

Over the past two decades many hundreds of tests have been performed in the U.S., Japan and New Zealand to determine the strength and ductility of concrete block and clay brick shear walls subjected to cyclic lateral load patterns. From these tests come equations to predict the shear strength of walls usually calibrated to the tests carried out by the particular researcher. Fattal and Todd (1991) compared the predictions of four different equations with available experimental results. The only flaw in this work was that they included the *UBC* design equations with the inference that the *UBC* equations were predictive equations for the ultimate shear strength of masonry. This is not the intent of

the *UBC* equations. They were developed and then modified as part of the code development process to provide a lower bound on the shear capacity of masonry walls. Two other reports/papers were reviewed as part of preparing this overview document; Blondet et al. (1989) and Anderson and Priestley (1992) also looked at predictive equations which were more simplified than those included in the Fattal and Todd review. As a consequence, a total of six different predictive methods have been reviewed.

In summary, the methods include two or more of the following components:

$$V_u = V_m + V_{sh} + V_{sv} + V_p \quad (\text{C11.7.3-1})$$

where:

$V_m$  = contribution of the masonry

$V_{sh}$  = contribution of the horizontal steel

$V_{sv}$  = contribution of the vertical steel

$V_p$  = contribution of the axial load

The report by Fattal and Todd (1991) is quite thorough and the test data used to assess the Shing, Matsamura, and Architectural Institute of Japan (AIJ) predictive equations were also used to assess the methods proposed by Blondet et al. (1989) and Anderson and Priestley (1992) and the final TCCMaR equations that were developed as part of the TCCMaR study. The form of these equations are given in Table C11.7.3-2. Rather than present the details of each of the test results that were developed, a statistical summary is provided in Table C11.7.3-1. This provides the overall average, standard deviation and coefficient of variation for all 62 tests included in the Fattal and Todd report. The values given in Table C11.7.3-1 are the ratio of the shear strength obtained by the predictive equation divided by the ultimate strength obtained from the test. A perfect prediction has a ratio of 1 and a conservative prediction has a ratio less than 1.

**TABLE C11.7.3-1**

Tests	Shing	Okamoto	Matsamura	Blondet et al.	Anderson & Priestley	TCCMaR
All 62 tests						
Mean	0.83	0.81	0.91	1.03	1.06	1.02
Standard Deviation	0.23	0.27	0.20	0.24	0.23	0.24
Coefficient of Variation	0.05	0.07	0.04	0.06	0.05	0.05
Mean Values						
Tests 1-10 (Shing)	0.94	1.25	0.93	0.88	1.02	0.87
Tests 11-27 (Matsumura)	0.89	0.82	0.99	1.10	1.13	1.07

Tests	Shing	Okamoto	Matsamura	Blondet et al.	Anderson & Priestley	TCCMaR
Tests 27-38 (Okamoto)	0.65	0.76	0.75	0.80	0.86	0.81
Tests 39-62 (Sveinsson)	0.82	0.66	0.91	1.13	1.11	1.12

Also included in Table C11.7.3-1 are the mean values of the four different sets of tests. Test 1-10 are from Shing et al. (1991), Tests 11-28 are from Matsamura (1987), Tests 29-37 are from Okamoto et al. (1987), and Tests 38-62 are from Sveinsson et al. (1985).

**TABLE C11-7.3-2**

As part of the TCCMaR studies, it was decided to use a combination of the Blondet et al. and Anderson and Priestley equations. In comparing the manner in which the two methods account for contribution of the masonry component, it was decided to use the Blondet form. As part of the Berkeley tests (Mayes et al., 1976, Chen et al., 1978, Hidalgo et al., (1978, 1979), it was concluded that the  $M/Vd$  ratio should be part of the masonry equation rather than just a straight function of  $2.9\sqrt{f'_m}$  as in the Anderson and Priestley equation. Furthermore, there was very little numerical difference in the values used to account for the vertical load contribution. As a consequence, it was decided to use the more simplified form of  $0.25\sigma_c$  used by Anderson and Priestley. The final form of the TCCMaR equation was given as:

$$v = (4 - 1.75 M/Vd)\sqrt{f'_m} + 0.5\rho_h f_{yh} + 0.25\sigma_c \quad (\text{C11.7.3-2})$$

The metric equivalent of Eq. C11.7.3-2 is:

$$v = 0.083(4 - 1.75 M/Vd)\sqrt{f'_m} + 0.5\rho_h f_{yh} + 0.25\sigma_c$$

Some members of TCCMaR believed that some contribution of vertical steel should be included and this issue was investigated. Many of the test specimens only included jamb steel and consequently two different vertical steel contributions were investigated:  $1/4\rho_v f_{yv}$  and  $1/4\rho_{vi} f_{yvi}$  where  $\rho_v$  is the total vertical steel and  $\rho_{vi}$  is only the interior vertical steel and neglects the jamb steel. The correlation and the test results were not as good when a contribution from vertical steel was included and consequently it was decided not to include it in the recommended TCCMaR shear equation.

Application of the shear strength equation to partially grouted masonry was based in part on Fattal (1993a and 1993b).

## 11.8 SPECIAL REQUIREMENTS FOR BEAMS:

**11.8.1:** Masonry beams may be loaded normal to their plane by wind or earthquake forces. The beam must have adequate strength to span between support points under the action of the out-of-plane loads. The arbitrary limits of 50 and 32 were judged to be adequate absolute limits on the unbraced span to beam width ratios for the conditions listed.

**11.8.2:** Gravity loading of a masonry beam may be applied eccentrically to its vertical centroidal plane. The lateral supports of the masonry building should restrain the beam from rotation under the eccentric action of the gravity load.

If the beam is supported laterally at one edge only (top or bottom), then the lateral support should have the moment capacity to restrain the rotation caused by loading normal to the face of the beam that is eccentric to the support point.

**11.8.3:** A minimum amount of flexural reinforcement in the positive moment zone of the beam is specified. This minimum is specified as a ratio,  $\rho$ , of the quantity of the reinforcement to the cross-

sectional area of the beam. The minimum ratio specified is intended to require that the post-cracked moment capacity exceeds the uncracked moment capacity of the section.

These requirements for a minimum quantity of positive moment reinforcement assumes that cracking has occurred in zones of negative moment and that the change in beam stiffness has increased the positive moment. However, if the positive moment capacity of the reinforced section exceeds the uncracked positive moment capacity, transfer of moment to this zone is accommodated.

If a section of the adjacent concrete floor serves as the compression flange of the beam, minimum reinforcement is based on the masonry section which is in tension due to positive moment.

**11.8.4 DEEP FLEXURAL MEMBERS:** The theory used for design of beams has a limited applicability to deep beams. Shear warping of the cross section and a combination of diagonal tension stress and flexural tension stress in the body of the deep beam requires that deep beam theory be used for design of members that exceed the specified limits of span to depth ratio. Analysis of wall sections that are used as beams generally will result in a distribution of tensile stress that requires the lower one-half of the beam section to have uniformly distributed reinforcement. The uniform distribution of reinforcement resists tensile stress caused by shear as well as flexural moment.

The flexural reinforcement for deep beams must meet or exceed the minimum flexural reinforcement ratio of Sec. 11.8.3. Additionally, horizontal and vertical reinforcement must be distributed throughout the length and depth of deep beams and must provide reinforcement ratios of at least 0.001. Distributed flexural reinforcement may be included in the calculations of the minimum distributed reinforcement ratios.

Flexural reinforcement that is lumped entirely at the bottom and/or top of a deep flexural member, however, should be ignored when calculating the distributed horizontal reinforcement ratio. In such a case, the lumped flexural steel must provide a minimum flexural reinforcement ratio of  $120/f_y$  in accordance with Sec. 11.8.3. For Grade 60 steel, this requirement is equivalent to a minimum flexural reinforcement ratio of 0.002.

Although this flexural reinforcement ratio results in twice the ratio required by Sec. 11.8.4.3, the flexural steel is lumped at the top and/or bottom of the beam and is not uniformly distributed. Since the intent of Sec. 11.8.4.3 is to ensure a minimum quantity of uniformly distributed reinforcement throughout the depth of the deep beam, the lumped flexural steel is not considered when calculating the minimum distributed reinforcement ratios.

## **11.9 SPECIAL REQUIREMENTS FOR COLUMNS:**

**11.9.1:** Maximum and minimum limitations on the area of longitudinal reinforcement for columns are traditional values that have been in codes for many years. Minimum areas are limited so that creep of the masonry, which tends to transfer load from masonry to reinforcing steel will not result in increasing the stress in the steel to yield level. The maximum area limitation represents a practical limit on the amount of reinforcing steel in terms of economy and steel placement. No testing or research has been done to justify changes in these traditional values.

**11.9.2:** The minimum number of bars in columns also is a traditional number. It is obviously appropriate, however, to suit rectangular or square column shapes and tying requirements.



**11.9.3:** The lateral tie restrictions in this section are also traditional. The column tie bending requirements of Part c are to be as shown.

Reinforcement is restricted to an amount below the area required for flexural bending only in order to preserve a ductile failure condition (i.e., steel will reach ultimate yield strain before concrete reaches ultimate yield strain which would be defined as a brittle failure). It is therefore important to keep the reinforcement ratio low.

#### **11.10 SPECIAL REQUIREMENTS FOR WALLS:**

**11.10.1:** The flexural strength of reinforced walls loaded normal to the surface is required to exceed the uncracked flexural strength. The basis for this requirement is that a static over load on the wall may cause very large displacements before strain hardening in the reinforcement increases the cracked flexural strength to the value of the uncracked flexural strength.

#### **11.11 SPECIAL REQUIREMENTS FOR SHEAR WALLS:**

**11.11.1 through 11.11.5:** Detailing requirements for masonry shear walls have been reorganized for 1997 in Sec. 11.11.1 through 11.11.5 to provide direct correlations with those categories given as line items in Table 5.2.2: ordinary plain masonry shear walls, detailed plain masonry shear walls, ordinary reinforced masonry shear walls, intermediate reinforced masonry shear walls, and special reinforced masonry shear walls. This was done so that variable  $R$ ,  $\Omega$ , and  $C_d$  factors could be given for each shear wall category rather than specifying detailing requirements per the Seismic Design Category as was done in previous editions of the *Provisions*. This reorganization is more consistent with the other material chapters, which are organized by type of lateral-force-resisting elements (e.g., ordinary, intermediate, or special moment resisting frames).

The word “plain” refers to the condition when a wall is unreinforced or tensile stresses in reinforcement, if any, are neglected. The word “reinforced” refers to the condition when tensile stresses in reinforcement are considered in the design process. “Detailed plain” and “intermediate reinforced” walls must have minimum reinforcement per Seismic Design Category C whereas “ordinary plain” and “ordinary reinforced” walls do not need to have any minimum reinforcement. Reinforcement requirements for “special reinforced” walls follow the requirements for Seismic Design Categories D and E. Requirements in each Seismic Design Category that are not germane to masonry walls have been retained in Sec. 11.3.5 through 11.3.9. in newly.

**11.11.6 Flanged Shear Walls:** Tests on flanged shear walls (Priestley and Limin, 1990; Sieble et al., 1992) have indicated that if the conditions of Sec. 11.11.3.1 are satisfied, the flange will act in conjunction with the web as a part of the flexural member.

The tributary flange widths defined in Sec. 11.11.3.3 and 11.11.3.4 are considered to be values appropriate for predicting flexural behavior and strength. The values were taken from experimental results. This has significance when calculating probable shear force on the wall, which is related to the probable maximum flexural strength. For the calculation of maximum allowable reinforcement ratios, the reinforcement in the flange of the width specified in Sec. 11.11.3.4 must be considered as part of the maximum reinforcement ratio.

**11.11.7 Coupled Shear Walls:** Coupled shear walls are defined as shear walls in a common wall plane that are interconnected or coupled by spandrel beams. These beams are typically at each floor

level. The coupling beams can be a section of a reinforced concrete floor that has continuity with the shear walls. Caution should be exercised to distinguish between coupled shear walls and walls with openings. In a coupled wall system, the yield limit state is allowed only in the coupling beam and at the base of the shear wall. If the flexure or shear yield state occurs in the wall between coupling beams, the system is a wall with openings. This system has very limited ductility and should be redesigned to prevent yielding in the reinforced wall at points other than the base of the shear wall.

Conformance with the requirement that the coupling beams reach their moment limit state at or before the shear wall reaches its moment limit state need not be checked if the ratio of the depth of the shear wall to the depth of the coupling beams exceeds 3 or more and the length of the coupling beams is less than one-half of the story height. Linear elastic analyses of the coupled wall system are inadequate to determine the yield status of the shear wall and the coupling beams. The stiffness of the shear wall will degrade rapidly in the first story. The shear walls in the upper stories may be uncracked.

**11.11.7.2 Shear Strength of Coupling Beams:** The nominal shear strength of coupling beams must be equal to the shear caused by development of a full yield hinge at each end of the coupling beams. This nominal shear strength is estimated by dividing the sum of the calculated yield moment capacity of each end of the coupling beams,  $M_1$  and  $M_2$ , by the clear span length,  $L$ .

A coupling beam may consist of a masonry beam and a part of the reinforced concrete floor system. Reinforcement in the floor system parallel to the coupling beam should be considered as a part of the coupling beam reinforcement. The limit of the minimum width of floor that should be used is six times the floor slab thickness. This quantity of reinforcement may exceed the limits of Sec. 11.6.2.2 but should be used for the computation of the normal shear strength.

**11.13 GLASS-UNIT MASONRY AND MASONRY VENEER:** Chapters 11 and 12 of ACI 530-95/ASCE 5-95/TMS 402-95 have been newly introduced in the 1997 *Provisions* to address design of glass-unit masonry and masonry veneer. Direct reference is made to these chapters for design requirements. Investigations of seismic performance have shown that architectural components meeting these requirements perform well (Jalil, Kelm and Klingner, 1992, and Klingner, 1994).

## REFERENCES

- Abboud, B. E., X. Lu, and F. C. Schmitt. 1993. "An Evaluation of Three Current Deflection Methods for Predicting the Lateral Deflection of Masonry walls." In *Proceedings of the Sixth North American Masonry Conference*, Philadelphia, Pennsylvania, pp.73-85.
- Abboud, B. E., and A. A. Hamid. 1987. "A Comparative Study of the Flexural Behavior of Reinforced Block Masonry and Reinforced concrete Using Small Scale Model walls." In *Proceedings of the Fourth North American Masonry Conference*, Los Angeles, California.
- Abboud, B. E., A. A. Hamid, and H. G. Harris. 1990. "Small Scale Modeling of Concrete Block Masonry structures," *ACI Structural Journal* 87(2):145-155.
- Abboud, B. E. 1987. The Use of Small Scale Direct Models for Concrete Block Masonry Assemblages and Slander Reinforced walls Under Out-of-Plane Loads, Doctoral Thesis, Drexel University, Philadelphia, Pennsylvania.

- Blondet, J. M., R. L. Mayes, T. E. Kelley, R. R. Villablanca, and R. E. Klingner. 1989. *Performance of Engineered Masonry in the Chilean Earthquake of March 3, 1985: Implications for U.S. Design Practice*. Austin: Phil Ferguson Structural Engineering Laboratory, University of Texas.
- Brown, Russell H., and A. Rhett Whitlock. 1983. "Strength of Anchor Bolts in Grouted Masonry," *ASCE Journal of Structural Engineering* 109(6) June.
- CEB. 1995. "Design of Fastenings in Concrete (Draft CEB Guide, Parts 1 to 3)" and "Fastenings for Seismic Retrofitting (State-of-the-Art Report on Design and Application)," Task Group 3.5 (Embedments), Euro-International Concrete Committee (CEB), *CEB Bulletin D'Information No. 226*, Comite Euro-International du Beton, August.
- Chen, S. W., P. A. Hidalgo, R. L. Mayes, R. W. Clough, and H. D. McNiven. 1978. *Cyclic Loading Tests of Masonry Single Piers*, Vol. 2, EERC Report UCB/EERC-78/27. Berkeley: University of California Earthquake Engineering Research Center.
- Fattal, S. G. 1993a. *Strength of Partially Grouted Masonry shear walls*, Report NIST 5147. Gaithersburg, Maryland: National Institute of Standards and Technology.
- Fattal, S. G. 1993b. *The Effect of Critical Parameters on the Behavior of Partially Grouted Masonry shear walls Under Lateral Loads*, NIST Report NISTIR 5116. Gaithersburg, Maryland: National Institute of Standards and Technology.
- Fattal, S. G., and D. R. Todd. 1991. *Ultimate strength of Masonry walls: Prediction vs. Test Results*, NIST Report NISTIR 4633. Gaithersburg, Maryland: National Institute of Standards and Technology.
- Hamid, A. A., M. K. Hatem, H. G. Harris, and B. E. Abboud. 1990. Hysteretic Response and Ductility of Reinforced concrete Masonry walls Under Out-of-Plane Loading." In *Proceedings of the Fifth North American Conference*, Urbana, Illinois, pp. 397-410.
- Hamid, A. A., B. E. Abboud, M. W. Farah, M. K. Hatem, and H. G. Harris. 1989. "Response of Reinforced Block Masonry walls to Out-of-Plane Static Loads," in *U.S.-Japan Coordinated Program For Masonry Building Research Report 3.2(a)*, Drexel University.
- He, L., and N. Priestley. 1992. *Seismic Behavior of Flanged Masonry shear walls - Final Report*, TCCMaR Report 4.1-2.
- Hidalgo, P. A., R. L. Mayes, H. D. McNiven, and R. W. Clough. 1978. *Cyclic Loading Tests of Masonry Single Piers*, Vol. 1 and 3, EERC Report UCB/EERC-78/27 and 79/12. Berkeley, University of California Earthquake Engineering Research Center.
- Horton, R. T., and M. K. Tadros. 1990. "Deflection of Reinforced Masonry Members," *ACI Structural Journal* 87(4):73-85.
- Jail, I., W. Kelm, and R. E. Klingner. 1992. *Performance of Masonry and Masonry Veneer Buildings in the Loma Prieta Earthquake*. PMSEL Report 92-1. Austin: University of Texas, Department of Civil Engineering.
- Klingner, R. E. 1994. *Performance of Masonry Structures in the Northridge, California, Earthquake of January 17, 1991*. Boulder, Colorado: The Masonry Society.

Leiva, G., and R. Klingner. 1991. *In-Plane Seismic Resistance of Two-story Concrete Masonry shear walls with Openings*, TCCMaR Report 3.1(c)-2.

Limin, H., and N. Priestley. 1988. *Seismic Behavior of Flanged Masonry shear walls*, TCCMaR Report 4.1-1.

Malik, J. B., J. A. Mendonca, and R. E. Klingner. 1982. "Effect of Reinforcing Details on the Shear Resistance of Short Anchor Bolts Under Reversed Cyclic Loading," *Journal of the American Concrete Institute*, Proceedings, Vol. 79, No. 1, January-February, pp 3-11.

Matsumura, A. 1987. "Shear strength of Reinforced Hollow Unit Masonry walls." In *Proceedings of the 4th North American Masonry Conference*, Los Angeles, California.

Mayes, R. L., Y. Omote, and R. W. Clough. 1976. *Cyclic Shear Tests of Masonry Piers*, Vol. 1, Report 76-8. Berkeley: University of California Earthquake Engineering Research Center.

Merryman, K., G. Leiva, N. Antrobus, and R. Klingner. 1989. *In-Plane Seismic Resistance of Two-story Concrete Masonry Coupled Shear Walls*, TCCMaR Report 3.1(c)-1.

Okamoto, S., Y. Yamazaki, T. Kaminosono, M. Teshigawara, and H. Hirashi. 1987. "Seismic Capacity of Reinforced Masonry walls and Beams in Wind and Seismic Effects." In *Proceedings of the 18th joint Meeting, U.S. - Japan Panel on Wind and Seismic Effects*, ed. by N. J. Raufaste, Report NBSIR 87-3540. Gaithersburg, Maryland: National Institute of Standards and Technology.

Priestley, N., and H. Limin. 1990. "Seismic Response of T-Section Masonry shear walls." *TMS Journal* 9(1):10-19.

Seible, F., G. A. Hegemier, M. J. N. Priestley, G. R. Kingsley, A. Kurkchubasche, and A. Igarashi. 1992. *The U.S. - TCCMaR Five-story Full Scale Masonry Research Building Test - Preliminary Report*, TCCMaR Report 9.2-4.

Shaikh, A. Fattah. 1996. "Design of Hooked Anchor bolts in Concrete and Masonry: Proposed Code Provisions and Commentary," prepared for the National Codes and Standards Council, 1996.

Shing, P. B., J. Noland, H. Spaeh, E. Klamerus, and M. Schuller. 1991. *Response of Single-story reinforced masonry shear walls to In-Plane Lateral Loads*, TCCMaR Report 3.1(a)-2.

Shing, P. B., M. Schuller, and V. S. Hoskere. 1990. "In-Plane Resistance of Masonry shear walls," *ASCE Journal of Structural Engineering* 116(3).

Sveinsson, B. I., H. D. McNiven, and H. Sucuoglu. 1985. *Cyclic Shear Tests of Masonry Piers*, Vol 4, Report UCB/EERC 85-15. Berkeley: University of California Earthquake Engineering Research Center.

Wolde-Tinsae, A. M., R. H. Atkinson, and A. A. Hamid. 1993. "State-of-the-Art Modulus of Elasticity of Masonry." In *Proceedings of the Sixth North American Masonry Conference*. Boulder, Colorado: The Masonry Society.

The following Technical Coordinating Committee for Masonry Research task reports not specifically cited providing the substantiating data for the *strength* design criteria presented in this chapter are available through the Earthquake Engineering Research Center Library in Richmond, California (phone 415-231-9403):

**Task No. Author(s) and Title**

- 1.1-1: Atkinson and Kingsley, *Comparison of the Behavior of Clay & Concrete Masonry in Compression*, September 1985. 151 pgs.
- 1.2(a)-1: Hamid, A. A., G. F. Assis, and H. G. Harris, *Material Models for Grouted Block Masonry*, August 1988. 67 pgs.
- 1.2(a)-2: Assis, G. F., A. A. Hamid, and H. G. Harris, *Material Models for Grouted Block Masonry*, August 1989. 134 pgs.
- 1.2(b)-1: Young, J. M., and R. H. Brown, *Compressive Stress Distribution of Grouted Hollow Clay Masonry Under Strain Gradient*, May 1988, 170 pgs.
- 1.3-1: Atkinson, R. H., *An Assessment of Current Material Test Standards for Masonry Limit States Design Methods*, June 1991. 38 pgs.
- 2.1-1: Hart, G., and M. Basharkhah, *Slender Wall Structural Engineering Analysis Computer Program (Shwall, Version 1.01)*, September 1987. 68 pgs.
- 2.1-2: Hart, G., and M. Basharkhah, *Shear Wall Structural Engineering Analysis Computer Program (Shwall, Version 1.01)*. September 1987. 75 pgs.
- 2.1-3: Nakaki, D., and G. Hart, *Uplifting Response of Structures Subjected to Earthquake Motions*, August 1987. 200 pgs.
- 2.1-4: Hart, G., N. Sajjad, and M. Basharkhah, *Inelastic Column Analysis Computer Program (INCAP, Version 1.01)*, March 1988.
- 2.1-5: Hong, W. K., G. C. Hart, and R. E. Englekirk, *Force-Deflection Evaluation and Models for University of Colorado Flexural walls*, December 1989.
- 2.1-6: Hart, G. C., J. W. Jaw, and Y. K. Low, *SCM Model for University of Colorado Flexural Walls*, December 1989. 31 pgs.
- 2.1-7: Hart, G. C., N. Sajjad, and M. Basharkhah, *Inelastic Masonry Flexural Shear Wall Analysis Computer Program*, February 1990. 41 pgs.
- 2.1-8: Hart, G. C., R. Englekirk, M. Srinivasan, S. C. Huang, and D. J. Drag, *Seismic Performance Study, DPC Gymnasium, Elastic Time History Analysis Using SAP90*, February 1992. 41 pgs.
- 2.1-9: Hart, G. C., R. Englekirk, M. Srinivasan, S. C. Huang, and D. J. Drag, *Seismic Performance Study, TMS Shopping Center, Elastic Time History Analysis Using SAP90*, February 1992. 42 pgs.
- 2.1-10: Hart, G. C., R. Englekirk, J. W. Jaw, M. Srinivasan, S. C. Huang, and D. J. Drag, *Seismic Performance Study, RCJ Hotel*, February 1992. 51 pgs.
- 2.1-11: Hart, G. C., R. Englekirk, M. Srinivasan, S. C. Huang, and D. J. Drag, *Performance Study, 2-Story Masonry Wall-Frame Building*, February 1992. 112 pgs.

- 2.1-12: Hart, G. C., R. Englekirk, J. W. Jaw, M. Srinivasan, S. C. Huang, and J. D. Drag, *Seismic Performance Study, Designed by Tentative Limit States Design Standard*, February 1992. 75 pgs.
- 2.2-1: Ewing, R. D., A. El-Mustapha, and J. Kariotis, *FEM/I - A Finite Element Computer Program for the Nonlinear Static Analysis of Reinforced Masonry Building Components*, December 1987 (Revised June 1990). 124 pgs.
- 2.2-2: Ewing, R. D., *Parametric Studies on Reinforced Masonry Shear Walls Using FEM/I, A Nonlinear Finite Element Analysis Program*, March 1992.
- 2.2-3: Ewing, R. D., *Finite Element Analysis of Reinforced Masonry Building Components Designed by a Tentative Masonry Limit States Design Standard*, March 1992. 48 pgs.
- 2.3-1: Ewing, R., J. Kariotis, and A. El-Mustapha, *LPM/I, A Computer Program for the Nonlinear, Dynamic Analysis of Lumped Parameter Models*, August, 1987. 200 pgs.
- 2.3-2: Kariotis, J., A. El-Mustapha, and R. Ewing, *Influence of Foundation Model on the Uplifting of Structures*, July 1988. 50 pgs.
- 2.3-3: Kariotis, J., A. Rahman, and A. El-Mustapha, *Investigation of Current Seismic Design Provisions for Reinforced Masonry Shear Walls*, January 1990. 48 pgs.
- 2.3-4: Kariotis, J., A. Rahman, O. Waqfi, and R. Ewing, *Version 1.03 LPM/I - A Computer Program for the Nonlinear, Dynamic Analysis of Lumped Parameter Models*, February 1992. 227 pgs.
- 2.3-5: Kariotis, J., O. Waqfi, and R. Ewing, R., *A Computer Program Using Beam Elements for the Nonlinear, Dynamic Analysis of Lumped Parameter Models*, February 1992. 96 pgs.
- 2.3-6: Kariotis, J., and O. Waqfi, *Comparison of the Dynamic Response of a Damped MDOF Nonlinear Beam Model with an Equivalent SDOF Hysteretic Model*, April 1992. 88 pgs.
- 2.3-7: Kariotis, J., and O. Waqfi, *Recommended Procedure for Calculation of the Balanced Reinforcement Ratio*, February 1992. 73 pgs.
- 2.4(b)-1: Button, M. R., and R. L. Mayes, *Out-of-Plane Seismic Response of Reinforced Masonry Walls: Correlation of Full-Scale Test and Analytical Model Results*, March 1991. 65 pgs.
- 3.1(a)-1: Scrivener, J., *Summary of Findings of Cyclic Tests on Masonry Piers*, June 1986. 7 pgs.
- 3.1(a)-2: Shing, P. B., J. Noland, H. Spaeh, E. Klammer, and M. Schuller, *Response of Single-Story Reinforced Masonry Shear Walls to In-Plane Lateral Loads*, January 1991. 136 pgs.
- 3.1(b)-1: Seible, F., and H. LaRovere, *Summary of Pseudo Dynamic Testing*, February 1987. 46 pgs.
- 3.1(b)-2: Igarashi, A., F. Seible, and G. Hegemier, *Development of the Generated Sequential displacement Procedure and the Simulated Seismic Testing of the TCCMaR Three-Story In-Plane Walls*, June 1993.
- 3.1(c)-1: Merryman, K., G. Leiva, B. Antrobus, and R. Klingner, *In-Plane Seismic Resistance of Two-Story Concrete Masonry Coupled shear walls*, September 1989. 176 pgs.
-

- 3.1(c)-2: Leiva, G., and R. Klingner, *In-plane Seismic Resistance of Two-story Concrete Masonry Shear Walls with Openings*, August 1991. 326 pgs.
- 3.2(a)-1: Hamid, A., B. Abboud, M. Farah, K. Hatem, and H. Harris, *Response of Reinforced Block Masonry Walls to Out-of-Plane Static Loads*; September 1989. 120 pgs.
- 3.2(b)-1: Agbabian, M., S. Adham, S. Masri, V. Avanesian, and V. Traina, *Out-of-Plane Dynamic Testing of Concrete Masonry Walls*, Vol. 1 and 2, July 1989. 220 pgs.
- 3.2(b)-2: Blondet, M., and R. L. Mayes, *The Transverse Response of Clay Masonry Walls Subjected to Strong Motion Earthquakes*, Vol. 1: *General Information*, April 1991. 172 pgs.
- 3.2(b)-2: Blondet, M., and R. L. Mayes, *The Transverse Response of Clay Masonry Walls Subjected to Strong Motion Earthquakes*, Vol. 2: *Walls No. 4 and 6 (Group 1)*, April 1991. 267 pgs.
- 3.2(b)-2: Blondet, M., and R. L. Mayes, *The Transverse Response of Clay Masonry Walls Subjected to Strong Motion Earthquakes*, Vol. 3: *Walls No. 8, 9, 10 and 11 (Group 2)*, April 1991. 310 pgs.
- 3.2(b)-2: Blondet, M., and R. L. Mayes, *The Transverse Response of Clay Masonry Walls Subjected to Strong Motion Earthquakes*, Vol. 4: *Walls No. 3, 5, and 7 (Group 3)*, April 1991. 256 pgs.
- 4.1-1: He, L., and M. J. N. Priestley, *Seismic Behavior of Flanged Masonry Shear Walls*, May 1988. 119 pgs.
- 4.1-2: He, L., and M. J. N. Priestley, *Seismic Behavior of Flanged Masonry Shear Walls - Final Report*, November 1992. 279 pgs.
- 4.2-1: Hegemier, G., and H. Murakami, *On the Behavior of Floor-to-Wall Intersections in Concrete Masonry Construction: Part I: Experimental*.
- 4.2-2: Hegemier, G., and H. Murakami, *On the Behavior of Floor-to-Wall Intersections in Concrete Masonry Construction: Part II: Theoretical*.
- 5.1-1: Porter, M., and A. Sabri, *Plank Diaphragm Characteristics*, July 1990. 226 pgs.
- 5.2-1: Porter, M., F. Yeomans, and A. Johns, *Assembly of Existing Diaphragm Data*, July 1990. 142 pgs.
- 6.2-1: Scrivener, J., *Bond of Reinforcement in Grouted Hollow-Unit Masonry: A State-of-the-Art*, June 1986. 53 pgs.
- 6.2-2: Soric, Z., and L. Tulin, *Bond Splices in Reinforced Masonry*, August 1987. 296 pgs.
- 7.1-1: Paulson, T., and D. Abrams, *Measured Inelastic Response of Reinforced Masonry Building structures to Earthquake Motions*, October 1990. 294 pgs.
- 8.1-1: Hart, G., *A Limit State Design Method for Reinforced Masonry*, June 1988.

- 8.1-2: Hart, G., *Expected Value Design in the Context of a Limit State Design Methodology*, February 1990.
- 8.2-1: Hart, G., and G. T. Zorapapel, *Reliability of Concrete Masonry Wall Structures*, December 1991. 229 pgs.
- 8.2-2: Hart, G., and N. Sajjad, *Confinement in Concrete Masonry*, December 1990.
- 8.2-3: Hart, G., and J. Jang, *Seismic Performance of Masonry Wall Frames*, December 1991.
- 9.1-1: Kariotis, J. C., and A. W. Johnson, *Design of Reinforced Masonry Research Building*, September 1987. 42 pgs.
- 9.1-2: Kariotis, J. C., and O. M. Waqfi, *Trial Designs Made in Accordance with Tentative Limit States Design Standards for Reinforced Masonry Buildings*, February 1992. 184 pgs.
- 9.2-1: Seible, F., *Report on Large Structures Testing Facilities in Japan*, September 1985. 120 pgs.
- 9.2-2: Seible, F., *Design and Construction of the Charles Lee Powell Structural Systems Laboratory*, November 1986. 65 pgs.
- 9.2-3: Seible, F., *The Japanese Five-story Full Scale Reinforced Masonry Building Test*, January 1988. 100 pgs.
- 9.2-4: Seible, F., G. A. Hegemier, M. J. N. Priestley, G. R. Kingsley, A. Kurkchubasche, and A. Igarashi, *The U.S. - TCCMaR Five-story Full Scale Masonry Research Building Test - Preliminary Report*, October 1992. 58 pgs.
- 11.1-1: TCCMaR, *Summary Report: U.S. Coordinated Program for Masonry Building Research*, September 1985 to August 1986. 190 pgs.
- 11.1-2: TCCMaR, *Status Report: U.S. Coordinated Program for Masonry Building Research*, November 1988. 170 pgs.



## Appendix to Chapter 11 Commentary

### ALTERNATIVE MASONRY STRUCTURE DESIGN REQUIREMENTS

**11A.1.2 REFERENCE DOCUMENTS:** This section references the *Building Code Requirements for Masonry Structures* (Ref. 11A-1), which covers all types of masonry (clay, concrete, glass, stone, etc.). Construction and quality assurance requirements are included by reference to *Specifications for Masonry Structures* (ACI 530.1/ASCE 6/TMS 602). These design and construction documents reference nationally recognized testing standards and material standards developed by the American Society for Testing and Materials (ASTM) and others.

Concern has been expressed about the area of vertical reinforcement permitted in Sec. 3.1.2 of Ref. 11A-1. The percentage of the area of the grout space (minimum grout area) and the cover and clearance requirements in Chapter 11 of Ref. 11A-1 provide reasonable assurance that the strength of the reinforcement can be developed.

**11A.1.2.1 Modifications to Appendix A of Reference 11A-1:** Appendix A requirements of ACI 530/ASCE 5/TMS 402, "Special Provisions for Seismic Design," are based on seismic zones defined by ASCE 7, *Minimum Design Loads for Buildings and Other Structures*. To be consistent with the *NEHRP Recommended Provisions*, Table 11A.1.1 correlates seismic zones to Seismic Design Categories.

**11A.2 STRENGTH OF MEMBERS AND CONNECTIONS:** The strength of members and connections is based on working stress procedures multiplied by a factor to approximate typical capacity. Capacity is approximated to equal the allowable stress determined by Ref. 11A-1 multiplied by a 1.33 factor for load combinations that include wind or earthquake (Ref. 11A-1, Sec. 5.3.2) and further multiplied by a 2.5 factor.

The resulting approximate capacity is 3.3 times the allowable stress. The design strength is equal to the approximated capacity times the strength reduction factor,  $\phi$ , to achieve a reliable design level value.

**11A.2.1:** Splice length of reinforcement is based on the allowable stress in the reinforcement in accordance with Ref. 11A-1, Sec. 11.5.7. This allowable stress is not modified by the 2.5 factor from Sec. 11A-2 or by a strength reduction factor,  $\phi$ . Splice lengths required by these provisions are therefore identical to the splice length required by Ref. 11A-1.

**11A.3 RESPONSE MODIFICATION COEFFICIENTS:** Masonry designed in accordance with Chapter 10 of Ref. 11A-1 is required to have reinforcement to resist tension as well as minimum levels of reinforcement and detailing based on seismic zone (i.e., *NEHRP Recommended Provisions Seismic Design Category*). These requirements are intended to provide a level of inelastic cyclic straining capacity consistent with the response modification coefficients of Table 2.2.2 for reinforced masonry. Unreinforced masonry shear walls designed in accordance with Chapter 9 of Ref. 11A-1 that do not tolerate inelastic straining without loss of strength use lower response modification coefficients to ensure that unreinforced masonry shear walls remain within the elastic range when subjected to design level seismic forces.

**11A.4 SEISMIC DESIGN CATEGORY A:** Ref. 11A-1 permits three design methods for masonry:

1. Design allowing tensile stresses in masonry (Chapter 9, Reinforced Masonry),
2. Design neglecting tensile strength of masonry (Chapter 10, Unreinforced Masonry), and
3. Empirical design of masonry (Chapter 11, Empirical).

Any of the three methods are considered appropriate for designs in Category A.

**11A.5 SEISMIC DESIGN CATEGORY B:** Masonry may be designed by Methods 1, 2, or 3 described above; however, in Category B, design of the basic structural system must be based on a structural analysis in accordance with Methods 1 or 2 described above.

**11A.6 SEISMIC DESIGN CATEGORY C:** In addition to the requirements of Category B, minimum levels of reinforcement and detailing are required in accordance with Appendix A of Ref. 11A-1. Further, noncomposite wythes (i.e., cavity walls) and screen walls must meet the detailing requirements of Sec. 11A.6.1.1 and Sec. 11A.6.1.2, respectively.

**11A.7 SEISMIC DESIGN CATEGORY D:** In addition to the requirements of Category C, the area and spacing of shear reinforcement for shear walls must meet the requirements of Sec. 11A.7.2. Special inspection is required in accordance with Sec. 1.6.2.5.

**11A.8 Seismic Design Category E:** The additional requirements of Category E are intended to ensure that the structure remains functional after the earthquake.

## Chapter 12 Commentary

### WOOD STRUCTURE DESIGN REQUIREMENTS

**12.1 REFERENCE DOCUMENTS:** Wood construction practices have not been codified in a form that is standard throughout the country. A major change for the 1997 *Provisions* is the incorporation by reference of the *Load and Resistance Factor Standard for Engineered Wood Construction* (LRFD), ASCE 16-95 (Ref. 12-1). Engineered wood strength design as prescribed in these *Provisions* generally follows the LRFD specification (Ref. 12-1). Conventional light frame construction practice as prescribed in these *Provisions* generally follows the requirements of the *One- and Two-Family Dwelling Code*, Ref. 12-5, jointly sponsored by the three model code organizations. The *One- and Two-Family Dwelling Code* is a revised and updated version of the Federal Housing Administration's (FHA) *Minimum Property Standards*.

References 12-3 and 12-11 indicate that the term "structural-use panel" has replaced the term "plywood" and this change in terminology was reflected in the 1991 and 1994 *Provisions* and is continued in this 1997 edition. The term "structural-use panel" includes wood-based products manufactured to meet a performance standard (Ref. 12-11). One requirement of this performance standard is bracing or lateral force resistance capability. These products include oriented strand board (OSB), plywood, and composite panels.

Many wood frame structures are a combination of engineered wood and "conventional" light frame construction. Wood also is used in combination with other materials (American Institute of Timber Construction, 1985; Breyer, 1993; Faherty and Williamson, 1989; Hoyle and Woeste, 1989; Somayaji, 1992; Stalnaker and Harris, 1989). The requirements of the model building codes were used as a resource in developing the requirements introduced in the 1991 *Provisions* and further modified in this edition.

The general requirements of Chapter 12 cover construction practices necessary to provide a performance level of seismic resistance consistent with the purposes stated in Chapter 1. These requirements also may be related to gravity load capacity and wind force resistance which is a natural outgrowth of any design procedure.

For the 1997 *Provisions*, the reference documents for this chapter have been reordered and regrouped according to their primary focus into three subsections: Sec. 12.1.2.1, Engineered Wood Construction; Sec. 12.1.2.2, Conventional Construction; and Sec. 12.1.2.3, Materials Standards. This was purely an editorial change to make the chapter consistent with the other materials chapters.

**12.1.3 Definitions:** Definitions are provided in Chapter 2 of the *Provisions*. The intent is to make the definitions used in this chapter compatible with those used in other chapters and Ref. 12-1.

The term “tie-down (hold-down)” is specifically defined to emphasize that the intent of the tie-down is to resist load and deflection in the form of uplift of the chord of the shear wall. These devices are required to show zero slip relative to the chord before load is resisted. Unlike devices that are attached to the tie-down post with bolts fitted through over-drilled holes, the intent is that there be tight-fitting holes so that load is immediately resisted. Examples of such devices are those attached to the tie-down post with nails and then bolted through the sill plate to the foundation or stud of a wall below. If bolts or similar types of fasteners are used to connect the device to the chord, cyclic tests using sequential phased displacement tests procedure, or the equivalent, are required to show that no loss in wall capacity, ductility, or stiffness is experienced. The bolts shall be “finger tight” and friction between the tie-down device and the chord shall not be counted on to resist load. The tests shall also simulate the deformation patterns expected in a wall assembly during a seismic event.

**12.1.4 Notations:** These variable definitions are included to assist the reader in understanding the equations and tables used in the chapter. To the extent possible, these definitions are compatible with the usage of the symbols in other chapters of the *Provisions* and Ref. 12-1. The definition of “factored resistance” has been added as the values of  $\lambda\phi D$  to account for the time effect factor and resistance factor. This is the basis of all values presented in this chapter.

**12.2 DESIGN METHODS:** Prior to the publication of Ref. 12-1, typical design of wood frame structures followed the American Forest and Paper Association (AF&PA) *National Design Specification for Wood Construction* (NDS) (AF&PA, 1991). The NDS is based on “allowable” stresses and implied factors of safety. However, the design procedure provided by the *Provisions* was developed on the premise of the resistance capacity of members and connections at the yield level (ASCE, 1988; Canadian Wood Council, 1990 and 1991; Keenan, 1986). In order to accommodate this difference in philosophy, the 1994 and prior editions of the *Provisions* made adjustments to the tabulated “allowable” stresses in the reference documents.

With the completion of the *Load and Resistance Factor Standard for Engineered Wood Construction* (ASCE, 1995), the modifications and use of an “allowable” stress based standard is no longer necessary. Therefore, the 1997 *Provisions* includes the LRFD standard by reference (Ref. 12-1) and uses it as the primary design procedure for engineered wood construction. The one difference between the LRFD reference document and the *Provisions* is the use of the shear wall and diaphragm tables in the *Provisions*. The resistances shown in Tables 12.4.3-2a and b were reduced 10 percent to account for capacity reductions observed in cyclic testing of shear walls. (Dolan, 1996; Rose, 1996). This reduction should be reviewed during the 2000 revision of the *Provisions* when additional test data are available. However, the capacities provided for diaphragms were not reduced because the severe, repeated racking damage that occurred in shear walls has not been noted in diaphragms in recent earthquakes.

Conventional light-frame construction, a prescriptive method of constructing wood structures, is allowed for some performance categories. These structures must be constructed according to the requirements set forth in Sec. 12.5 and Ref. 12-5. If the construction deviates from these prescriptive requirements, then the engineered design requirements of Sec. 12.3 and 12.4 and Ref. 12-1 shall be followed. If a structure that is classified as conventional construction contains some structural elements that do not meet the requirements of conventional construction, the elements in question can be engineered in accordance with Section 12.2.2.1 without changing the rest of the structure to engineered construction. The extent of design to be provided must be determined by the responsible

registered design professional; however, the minimum acceptable extent is often taken to be force transfer into the element, design of the element, and force transfer out of the element. This does not apply to a structure that is principally an engineered structure with minor elements that could be considered conventional. When more than one braced wall line or diaphragm in any area of a conventional residence requires design, the nature of the construction may have changed, and engineered design might be appropriate for the entire lateral-force-resisting system. The absence of a ceiling diaphragm may also create a configuration that is non-conventional. The requirement for engineering portions of a conventional construction structure to maintain lateral-force resistance and stiffness is added to provide displacement compatibility. This is similar to the requirement in Sec. 12.3.3.

**Alternate Strength of Members and Connections:** It remains the intent of the *Provisions* that load and resistance factor design be used. This is the first time that a strength based standard has been available for reference. When allowable stress design is to be used, however, the factored resistance of members and connections subjected to seismic forces acting alone or in combination with other prescribed loads shall be determined using a capacity reduction factor,  $\phi$ , times 2.16 times the allowable stresses permitted in the *National Design Specification for Wood Construction* (NDS) and supplements (AF&PA, 1991). The allowable stresses used shall not include a duration of load factor,  $C_D$ . The value of the capacity reduction factor,  $\phi$ , shall be as follows:

Wood members

In flexure	$\phi = 1.00$
In compression	$\phi = 0.90$
In tension	$\phi = 1.00$
In shear and torsion	$\phi = 1.00$

Connectors

Anchor bolts, bolts, lag bolts, nails, screws, etc.	$\phi = 0.85$
Bolts in single shear in members that are part of a seismic-force-resisting system	$\phi = 0.40$

These “soft” conversions from allowable stress design values to load and resistance factor design values appeared in Sec. 9.2 in the 1994 *Provisions*. For the 1997 *Provisions*, the factored resistance of shear walls and diaphragms shall be in accordance with Tables 12.4.3-1a and b and Tables 12.4.3-2a and b.

An alternative method of calculating soft conversions is provided in ASTM D5457-93. The reader is cautioned, however, that the loads and load combinations to be used for conversion are not specified so it is incumbent upon the user to determine appropriate conversion values.

**12.3 ENGINEERED WOOD CONSTRUCTION:** Engineered construction for wood *structures* as defined by these *Provisions* encompasses all structures that cannot be classified as conventional construction. Therefore, any structure exceeding the height limitations or having braced walls spaced at greater intervals than prescribed in Table 12.5.1-1 or not conforming to the requirements in Sec. 12.5 must be engineered using standard design methods and principles of mechanics. Framing members in engineered wood construction are sized based on calculated capacities to resist the loads and forces imposed. Construction techniques that utilize wood for lateral force resistance in the form of diaphragms or shear walls are discussed further in Sec. 12.4. Limitations have been set on the use of

wood diaphragms that are used in combination with concrete and masonry walls or where torsion is induced by the arrangement of the vertical resisting elements. A load path must be provided to transmit the lateral forces from the diaphragm through the vertical resisting elements to the foundation. It is important for the registered design professional to follow the forces down, as for gravity loads, designing each connection and member along the load path.

Although wood moment resisting frames are not specifically covered in the *Provisions*, they are not excluded by them. There are several technical references for their design, and they have been used in Canada, Europe, and New Zealand. Wood moment resisting frames are designed to resist both vertical loads and lateral forces. Detailing at columns to beam/girder connections is critical in developing frame action and must incorporate effects of member shrinkage. Detailed information can be obtained from the national wood research laboratories.

There are many references that describe the engineering practices and procedures used to design wood structures that will perform adequately when subjected to lateral forces. The list at the end of this *Commentary* chapter gives some, but by no means all, of these.

Changes in the 1997 *Provisions* include editorial changes to improve clarity or enforceability or to make the provisions more compatible with the LRFD specification. Significant additions to Sec. 12.3 include displacement compatibility requirements and provisions governing horizontal distribution of shear.

**12.3.2 Framing Requirements:** All framing that is designed as part of an engineered wood structure must be designed with connectors that are able to transfer the required forces between various components. These connectors can be either proprietary hardware or some of the more conventional connections used in wood construction. However, the capacity of these connectors should be designed according to accepted engineering practice to ensure that they will have the capacity to resist the forces. The requirement of columns and posts being framed to full end bearing requires that the force transfer from the column to the base be accomplished through end grain bearing of the wood, not through placing the bolts or other connectors in shear. This requirement is included to ensure adequate capacity for transfer of the vertical forces due to both gravity and overturning moment. Alternatively, the connection can be designed to transfer the full loading through placing the bolts or other connectors in shear neglecting all possible bearing.

**12.3.3 Deformation Compatibility Requirements:** The intent of this section is to require the registered design professional to visualize the deformed shape of the structure to ensure that the connections provide the necessary ductility to allow the probable deflection demand placed on the structure. Unlike steel or other metal structures, wood is not a ductile material and virtually all of the ductility achieved in the structure is from the metal connections. The planned failure mechanism of wood structures must be through the connections, including the nailing of structural panels, otherwise the failure will be brittle in nature. The philosophy of strong elastic columns and yielding beams cannot be projected from steel to wood structures. To enable a wood structure to deform and dissipate energy during a seismic event, the connections must be the weak link in the structure and be ductile. Recent earthquakes, such as that in Northridge, California, have shown failures due to the fact that consideration of deformation compatibility was neglected.

As an example of a compatibility issue, consider the deformation compatibility between a tie-down connector to the tie-down post and the edge nailing of shear wall sheathing to the tie-down post and

adjacent bottom plate. Recent testing and observations from the Northridge earthquake have suggested that the tie-down post experiences notable displacement before significant load can be carried through the tie-down connector. This is due, among other things, to the oversizing of the bolt holes in the tie-down post and the deformation and rotation of the tie-down bracket. Anchor bolts connecting the bottom plate to the foundation below tend to attempt to carry the shear wall uplift as the tie-down post moves. The sheathing, however, is nailed to both the bottom plate, which is held in place, and the tie-down post, which is being pulled up. The result is a large deformation demand being placed on the nails connecting the sheathing to the framing. This often results in the nails pulling out of the sheathing at the tie-down post corner and sometimes results in an unzipping effect where a significant portion of the remaining sheathing nailing fails as high loads cause one nailed connection to fail and move on to overstress the next nail. The most effective solution currently known is to limit the slip and deformation at the tie-down post by using a very stiff nailed or screwed tie-down.

Because this is an area where understanding of compatibility issues is just starting to develop, the Sec. 12.3.3 provision uses the wording “shall be considered in design” in lieu of the originally proposed “provision shall be made to ensure...” The intent is to provide guidance while not requiring the impossible. Equations for estimating diaphragm and shear wall deflections are discussed in Sec. 12.4.1 of this commentary.

If necessary, the stiffness of the wood diaphragms and shear walls can be increased with the use of adhesives (if adhesives are to be used, see *Commentary* Sec. 12.4). However, it should be noted that there are no rational methods for determining deflections in diaphragms that are constructed with non-wood sheathing materials. If the nail stiffness values or shear stiffness of non-wood sheathing materials is determined in a scientific manner, such as through experimental cyclic testing (e.g., see Sec. 12.4 of the *Commentary*), the calculations for determining the stiffness of shear panels will be considered validated.

**12.3.4 Design Limitations:** Again, the consideration of deformation compatibility is a primary consideration in engineered wood construction. This is especially true if the effective stiffnesses at load levels experienced are not compatible between lateral load resisting elements considered. The inter-story drift limits also must be considered when designing the structure.

**12.3.4.1 Wood Members Resisting Horizontal Seismic Forces Contributed by Masonry and Concrete:** Due to the significant difference in in-plane stiffness between wood and masonry or concrete systems, the use of wood members to resist the seismic forces produced by masonry and concrete is not allowed. This is due to the probable torsional response such a structure will exhibit. There are two exceptions where wood can be considered to be part of the lateral-load-resisting system. The first is when the wood is in the form of a horizontal truss or diaphragm and the lateral loads do not produce rotation of the horizontal member. The second exception is in structures of two stories or less in height. In this case, the capacity of the wood shear walls will be sufficient to resist the lower magnitude loads imposed. Five restrictions are imposed on these structures to ensure that the structural performance will not include rotational response and the drift will not cause failure of the masonry or concrete portions of the structure.

**12.3.4.2 Horizontal Distribution of Shear:** This section of the *Provisions* is intended to define when a diaphragm can be considered to be flexible or rigid. The purpose is to determine whether the diaphragm should have the loads proportioned according to tributary area or stiffness. For flexible

diaphragms, the loads should be distributed according to tributary area whereas for rigid diaphragms, the loads should be distributed according to stiffness. The remainder of the intent of this section is covered in the general discussion for Sec. 12.3.4 above.

The distribution of seismic forces to the vertical elements (shear walls) of the lateral force resisting system is dependent, first, on the relative stiffness of the vertical elements versus the horizontal elements and, second, on the relative stiffness of the vertical elements when they have varying deflection characteristics. The first issue is discussed in detail in the *Provisions*, which define when a diaphragm can be considered flexible or rigid and set limits on diaphragms that act in rotation or that cantilever. The second is largely an issue of engineering mechanics, but is discussed in Sec. 12.4 of this commentary because significant variations in engineering practice currently exist.

In situations where a series of vertical elements of the lateral force resisting system are aligned in a row, seismic forces will distribute to the different elements according to their relative stiffness.

Typical current design practice is to distribute seismic forces to a line of structural-use panel sheathed walls in proportion to the lengths of the wall segments such that each segment carries the same unit load. Structural-use panel sheathed wall segments without openings can generally be calculated to have a stiffness in proportion to the wall length when: the tie-down slip is ignored, the structural-use panel sheathing is selected from Tables 12.4.3-2a and b, and the aspect ratio limits of these provisions are satisfied. For stiffness to be proportional to the wall length, the average load per nail for a given nail size must be approximately equal. Conversely, a wall could be stiffened by adding nails and reducing the calculated average load per nail. When including tie-down (hold-down) slip from anchors with negligible slip (1/16 in, 2 mm or less), the assumption of wall stiffness proportional to length is still fairly reasonable. For larger tie-down slip values, wall stiffness will move towards being proportional to the square of the wall length; more importantly, however, the anchorage will start exhibiting displacement compatibility problems as discussed in Sec. 12.3.3. For shear walls with aspect ratios higher than 2/1, the stiffness is no longer in proportion to the length and equations are not available to reasonably calculate the stiffness. For a line of walls with variations in tie-down slip, chord framing, unit load per nail, or other aspects of construction, distribution of load to wall segments will need to be based on a deflection analysis. The shear wall and diaphragm deflection equations that are currently available are not always accurate. As testing results become available, the deflection calculation formulas will need to be updated and design assumptions for distribution of forces reviewed.

**Torsional Diaphragm Force Distribution:** Sec. 12.3.4.2 defines a diaphragm as being flexible when the maximum lateral deformation of the diaphragm is more than two times the average story drift. Conversely, a diaphragm will be considered rigid when the diaphragm deflection is equal to or less than two times the story drift. This is based on a model building code definition that applies to all materials.

For flexible diaphragms, seismic forces should be distributed to the vertical resisting elements according to tributary area or simple beam analysis. Although rotation of the diaphragm may occur because lines of vertical elements have different stiffnesses, the diaphragm is not considered stiff enough to redistribute seismic forces through rotation. The diaphragm can be visualized as a single-span beam supported on rigid supports.

For diaphragms defined as rigid, rotational or torsional behavior is expected and results in redistribution of shear to the vertical-force-resisting elements. Requirements for horizontal shear distribution are in Sec. 5.3.5. Torsional response of a structure due to irregular stiffness at any level



within the structure can be a potential cause of failure. As a result, dimensional and diaphragm ratio limitations are provided for different categories of rotation. Also, additional requirements apply when the structure is deemed to have a torsional irregularity in accordance with Table 5.2.3.2, Item 1.

In order to understand limits placed on diaphragms acting in rotation, it is helpful to consider two different categories of diaphragms. Category I includes rigid diaphragms that rely on force transfer through rotation to maintain stability. An example would be an open front structure with shear walls on the other three sides. For this more structurally critical category, applicable limitations are:

- Sec. 12.3.4.1 -- Diaphragm not to be used to resist forces contributed by masonry or concrete in structures over one story.
- Sec. 12.3.4.2, second paragraph -- The length of the diaphragm normal to the opening not to exceed 25 feet ( to perpendicular shear walls), and diaphragm  $l/w$  ratios limited as noted.
- Sec. 12.3.4.2, fourth paragraph -- Additional limitations when rotation is significant enough to be considered a torsional irregularity.

Category II includes rigid diaphragms that have two or more supporting shear walls in each of two perpendicular directions but, because the center of mass and center of rigidity do not coincide, redistribute forces to shear walls through rotation of the diaphragm. These can be further divided into Category IIA where the center of rigidity and mass are separated by a small portion of the structure's least dimension and the magnitude of the rotation is on the order of the accidental rotation discussed in Sec. 5.3.5.2. For this level of rotation, Sec. 12.3.4.1 Exception 1 might be considered applicable and, as a result, no particular limitations would be placed on diaphragm rotation for Category IIA. Category IIB, rigid diaphragms with eccentricities larger than those discussed in Sec. 5.3.5.2, are subject to the following limitations:

- Sec. 12.3.4.1 -- Diaphragm not to be used to resist forces contributed by masonry or concrete in structures over one story.
- Sec. 12.3.4.2, fourth paragraph -- Additional limitations when rotation is significant enough to be considered a torsional irregularity.

Sec. 12.4 and Tables 12.4.3-1a and b provide limits for diaphragm ratios. Because flexible diaphragms have very little capacity for distributing torsional forces, further limitation of aspect ratios is used to limit diaphragm deformation such that rigid behavior will occur. The resulting deformation demand on the structure also is limited. Where diaphragm ratios are further limited, exceptions permit higher ratios where calculations demonstrate that higher diaphragm deflections can be tolerated. In this case, it is important to determine the effect of diaphragm rigidity on the horizontal distribution and also the ability of other structural elements to withstand resulting deformations.

Proposals to prohibit wood diaphragms acting in rotation were advanced following the 1994 Northridge earthquake. To date, however, the understanding is that the notable collapses in the Northridge Earthquake occurred in part because of lack of deformation compatibility between the various vertical resisting elements rather than because of the inability of the diaphragm to act in rotation.

**Diaphragm Cantilever:** Limitations concerning diaphragms that cantilever horizontally past the outermost shear wall (or other vertical element) are related to but distinct from those imposed because

of diaphragm rotation. Such diaphragms can be flexible or rigid and for rigid diaphragms can be Category I, IIA or IIB. Both the limitations based on diaphragm rotation (if applicable) and the following limit on diaphragm cantilever must be considered:

- Sec. 12.3.4.2, third paragraph -- Diaphragm cantilever not to exceed the lesser of 25 feet or two thirds of the diaphragm width.

**Relative Stiffness of Vertical Elements:** In situations where a series of vertical elements of the lateral force resisting system are aligned in a row, the forces will distribute to the different elements according to their relative stiffnesses. This behavior needs to be taken into account whether it involves a series of structural-use panel shear walls of different lengths, a mixture of structural-use panel shear walls with diagonal lumber or non-wood sheathed shear walls, or a mixture of wood shear walls with walls of some other material such as concrete or masonry. See the *Commentary* Sec. 12.3.3 for a discussion of deflection compatibility of structural elements.

**12.3.4.3 Framing and Anchorage Limitations:** The anchorage connections used in engineered wood construction must be capable of resisting the forces that will occur between adjacent members (beams and columns) and elements (diaphragms and shear walls). These connections can utilize proprietary hardware or be designed in accordance with principles of mechanics. Connections are often the cause of structural failures in wood structures, and the registered design professional is cautioned to use conservative values for allowable capacities since most published values are based on monotonic, not cyclic, load applications (National Oceanic and Atmospheric Administration, 1971). Testing has shown that some one-sided bolted connections subject to cyclic loading, such as tie-down devices, do not perform well. This was substantiated by the poor performance of various wood frame elements in structures in the January 1994 Northridge earthquake.

**Anchorage of Concrete or Masonry Walls** Concrete or masonry wall anchorages using toe nails or nails subject to withdrawal are prohibited by these *Provisions*. It has been shown that these types of connections are inadequate and do not perform well (U.S. Department of Agriculture, National Oceanic and Atmospheric Administration, 1971). Ledgers subjected to cross-grain bending or tension perpendicular to grain also have performed poorly in past earthquakes, and their use is now prohibited by these *Provisions*.

**12.3.4.4 Shear Wall Anchorage:** Tie-down devices that permit significant vertical movement between the tie-down and the tie-down post can cause failure in the nails connecting the shear wall sheathing to the sill plate. High tension and tie-down rotation due to eccentricity can cause the bolts connecting the tie-down bracket to the tie-down post to pull through and split the tie-down post. Devices that permit such movement include heavily loaded one-sided bolted connections with small dimensions between elements resisting rotation due to eccentricity. Any device that uses over-drilled holes such as most bolted connections will also allow significant slip to occur between the device and the tie-down post before load is restrained. Both the NDS and the steel manual specify that bolt holes will be over-drilled as much as 1/16 in (2 mm). This slip is what causes much of the damage to the nails connecting the sheathing to the sill plate. Friction between the tie-down post and the device cannot be counted on to resist load because relaxation in the wood will cause a loss of clamping and, therefore, a loss in friction over time. This is why all tests should be conducted with the bolts “finger tight” as opposed to tightening with a wrench.

Cyclic tests of tie-down connections shall follow a pattern similar to the sequential phased displacement (SPD) tests used by Dolan (1996) and Rose (1996). These tests used full wall assemblies and therefore induced deflection patterns similar to those expected during an earthquake. If full wall assembly tests are not used to test the tie-down devices, it must be shown that the expected rotation as well as tension and compression are used. This is to ensure that walls using the devices will be able to deform in the intended manner. This allows the registered design professional to consider compatibility of deformations when designing the structure.

Splitting of the bottom plate of the shear walls has been observed in tests as well as in structures subjected to earthquakes. Splitting of plates remote from the end of the shear wall can be caused by the rotation of individual sheathing panels inducing upward forces in the nails at one end of the panel and downward forces at the other. With the upward forces on the nails and a significant distance perpendicular to the wall to the downward force produced by the anchor bolt, high cross-grain bending stresses occur. Splitting can be reduced or eliminated by use of large plate washers sufficiently stiff to reduce the eccentricity and by using thicker sill plates. Thicker sill plates (3 in. nominal, 65 mm) are required for all shear walls for which Tables 12.4.3-2a and b require 3 in. nominal (65 mm) framing to prevent splitting due to close nail spacing. This is to help prevent failure of the sill plate due to high lateral loading and cross-grain bending.

The tendency for the nut on a tie-down bracket anchor bolt to loosen significantly during cycled loading has been observed in some testing. One tested method of limiting the loosening is to apply adhesive between the nut and tie-down bolt.

A logical load path for the structure must be provided so that the forces induced in the upper portions of the structure are transmitted adequately through the lower portions of the structure to the foundation.

**12.4 DIAPHRAGMS AND SHEAR WALLS:** Many wood-framed structures resist seismic forces by acting as a "box system." The forces are transmitted through diaphragms, such as roofs and floors, to reactions provided by shear walls. The forces are, in turn, transmitted to the lower stories and to the final point of resistance, the foundations. A shear wall is a vertical diaphragm generally considered to act as a cantilever from the foundation.

A diaphragm is a nearly horizontal structural unit that acts as a deep beam or girder when flexible in comparison to its supports and as a plate when rigid in comparison to its supports. The analogy to a girder is somewhat more appropriate since girders and diaphragms are made up as assemblies (American Plywood Association, 1991; Applied Technology Council, 1981). Sheathing acts as the "web" to resist the shear in diaphragms and is stiffened by the framing members, which also provide support for gravity loads. Flexure is resisted by the edge elements acting like "flanges" to resist induced tension or compression forces. The "flanges" may be top plates, ledgers, bond beams, or any other continuous element at the perimeter of the diaphragm.

The "flange" (chord) can serve several functions at the same time, providing resistance to loads and forces from different sources. When it functions as the tension or compression flange of the "girder," it is important that the connection to the "web" be designed to accomplish the shear transfer. Since most diaphragm "flanges" consist of many pieces, it is important that the splices be designed to transmit the tension or compression occurring at the location of the splice and to recognize that the direction of application of seismic forces can reverse. It should also be recognized that the shear walls parallel to

the flanges may be acting with the flanges to distribute the diaphragm shears. When seismic forces are delivered at right angles to the direction considered previously, the "flange" becomes a part of the reaction system. It may function to transfer the diaphragm shear to the shear wall(s), either directly or as a drag strut between segments of shear walls that are not continuous along the length of the diaphragm.

For shear walls, which may be considered to be deep vertical cantilever beams, the "flanges" are subjected to tension and compression while the "webs" resist the shear. It is important that the "flange" members, splices at intermediate floors, and the connection to the foundation be detailed and sized for the induced forces. The shear wall aspect ratios,  $h/w$ , have been limited to 2/1 in light of the poor performance of walls with larger aspect ratios in recent tests and in the January 1994 Northridge earthquake, and the results of recent research (Applied Technology Council, 1995; White and Dolan, 1996).

The "webs" of diaphragms and shear walls often have openings. The transfer of forces around openings can be treated similarly to openings in the webs of steel girders. Members at the edges of openings have forces due to flexure and the higher web shear induced in them and the resultant forces must be transferred into the body of the diaphragm beyond the opening.

In the past, wood sheathed diaphragms have been considered to be flexible by many registered design professionals and model code enforcement agencies. The newer versions of the model codes now recognize that the determination of rigidity or flexibility for determination of how forces will be distributed is dependent on the relative deformations of the horizontal and vertical resisting elements. Wood sheathed diaphragms in structures with wood frame shear walls with various types of sheathing may be relatively rigid compared with the vertical resisting system and, therefore, capable of transmitting torsional lateral forces. A relative deformation of the diaphragm of two or more when compared with the vertical resisting system deformation under the same force is used to define a diaphragm as being flexible.

Discussions of these and other topics related to diaphragm and shear wall design, such as cyclic testing, and pitched or notched diaphragms, may be found in the references.

**12.4.1 Diaphragm and Shear Wall Aspect Ratios:** The aspect ratio limits of Sec. 12.4.3.1 through 12.4.3.4 are unchanged from previous editions of the *Provisions*; however, definitions of the aspect ratios have been added. The  $l/w$  for a diaphragm and  $h/w$  for a shear wall discussed in the first paragraph are intended to be the typical definitions for aspect ratio. The diaphragm span,  $l$ , is measured perpendicular to the direction of applied force, either for the full dimension of the diaphragm or between supports as appropriate. The width,  $w$ , is parallel to the applied force (see Figure C12.4.1-1). The  $h$  of the shear wall is the clear story height (see Figure C12.4.1-2). The alternate definition of aspect ratio is only to be used where specific design and detailing is provided for force transfer around the openings. It is required that the individual wall piers meet the aspect ratio requirement (see Figure C12.4.1-3) and that the overall perforated wall also meet the aspect ratio requirement. Use of the alternate definition involves the design and detailing of chord and collector elements around the opening, and often results in the addition of blocking, strapping and special nailing. As noted, the design for force transfer around the opening must use a rational analysis, and in accordance with ASCE 16 which discusses design principles for shear walls, diaphragms and boundary elements.

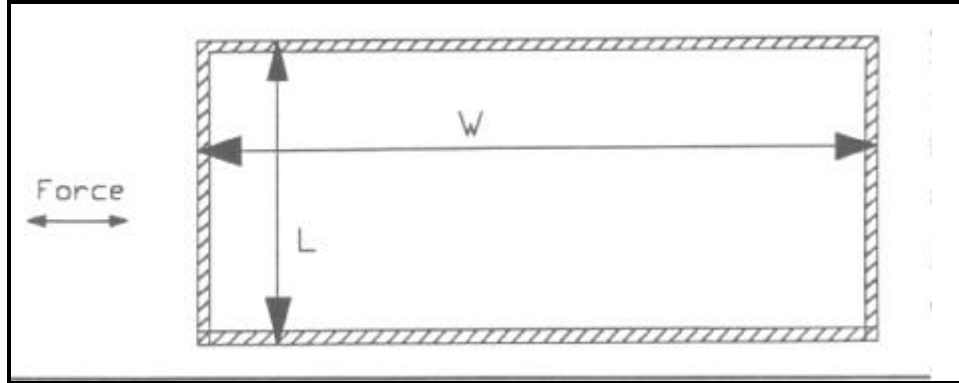

FIGURE C12.4.1-1. Diaphragm dimension definitions.

**Deflections:** The mid-span deflection of a simple-span blocked structural-use panel diaphragm uniformly nailed throughout may be calculated by use of the following formula:

$$\Delta = \frac{5v l^3}{8wEA} + \frac{v l}{4Gt} + 0.188 l e_n + \frac{\sum (\Delta_c X)}{2w}$$

where:

- $\Delta$  = the calculated deflection, in millimeters, or inches.
- $v$  = maximum shear due to factored design loads in the direction under consideration, in kilonewtons per meter, or pounds per lineal foot.
- $l$  = diaphragm length, in meters, or feet.
- $w$  = diaphragm width, in meters, or feet.
- $E$  = elastic modulus of chords, in megapascals, or pounds per square inch.
- $A$  = area of chord cross-section, in square millimeters, or square inches.
- $Gt$  = panel rigidity through the thickness, in Newtons per millimeter, or pounds per inch.
- $e_n$  = nail deformation, in millimeters, or inches
- $\sum (\Delta_c X)$  = sum of individual chord-splice slip values on both sides of the diaphragm, each multiplied by its distance to the nearest support, in millimeters, or inches.

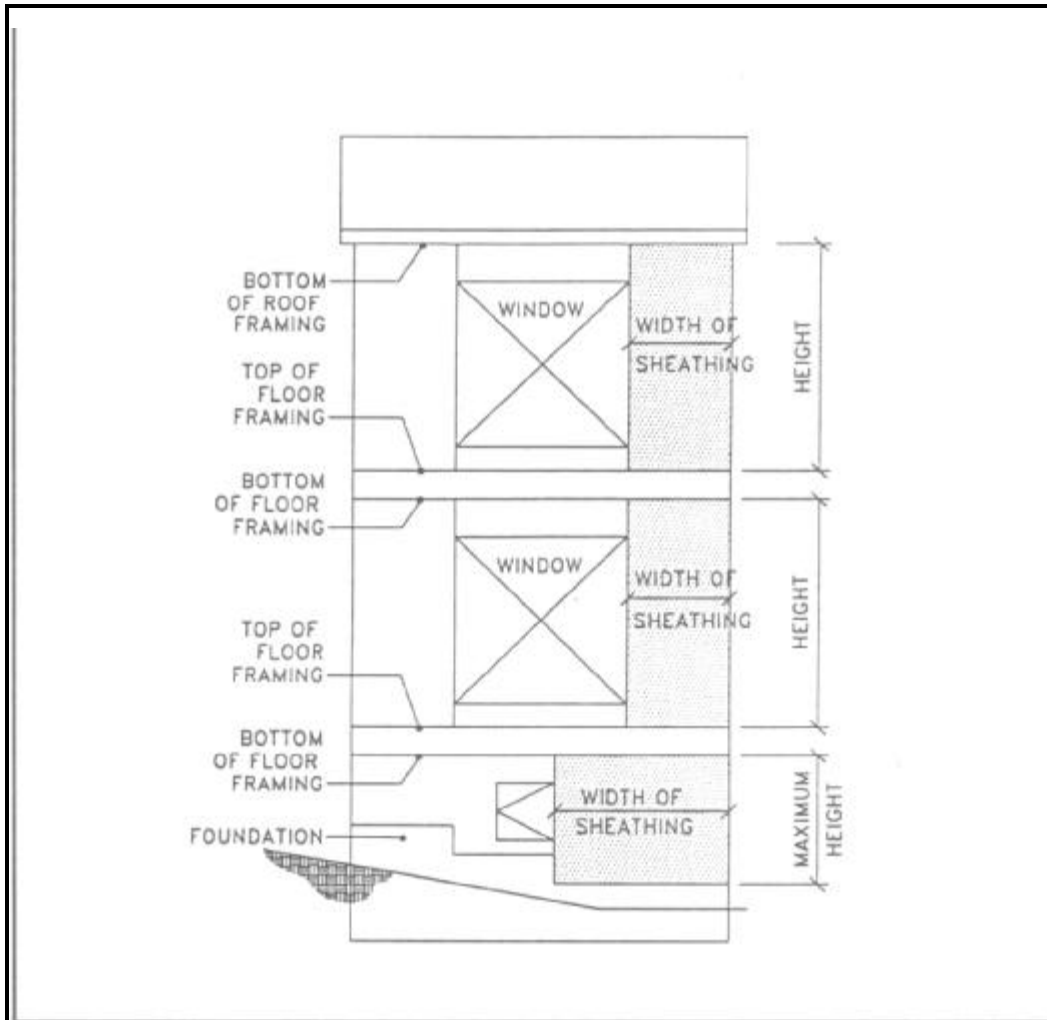
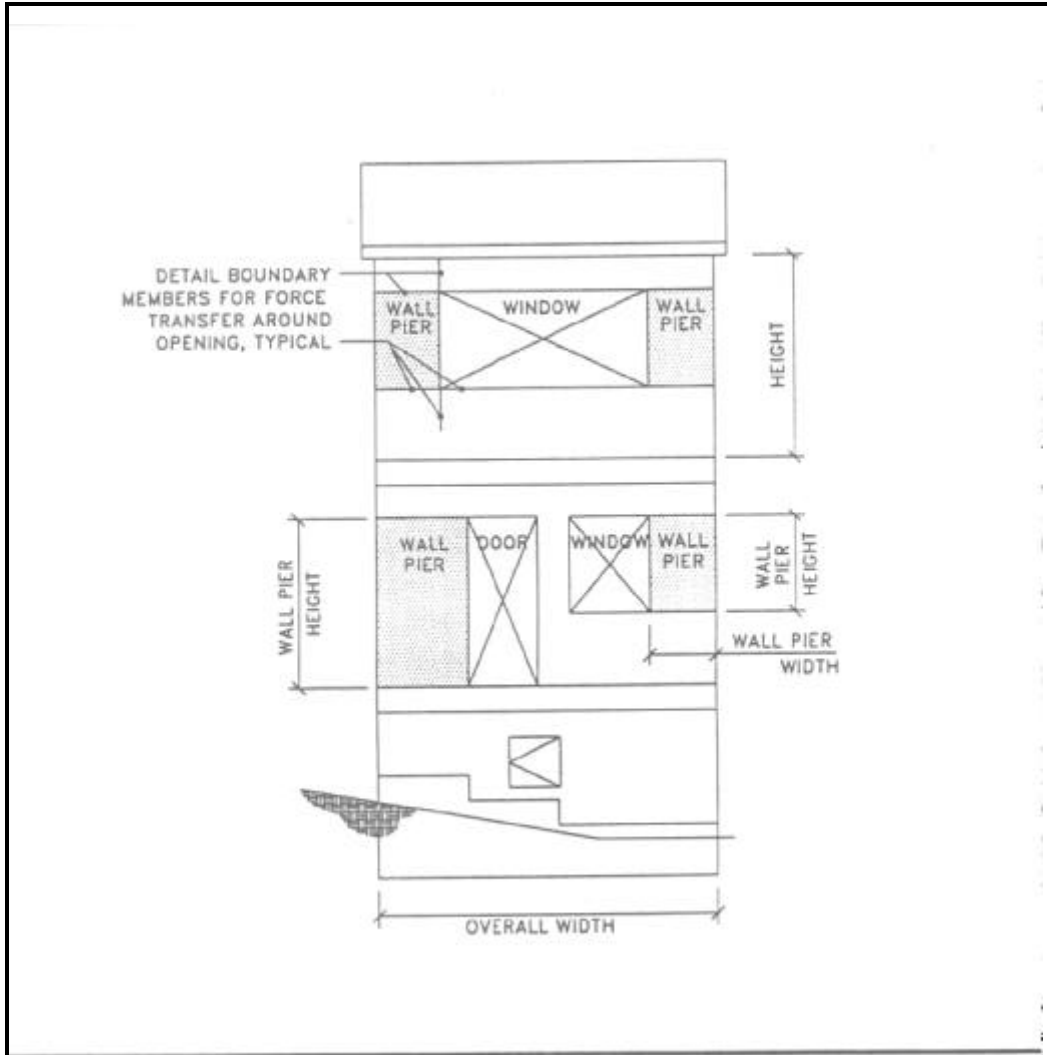

FIGURE C12.4.1-2 Typical shear wall height-to-width ratio.

If not uniformly nailed, the constant 0.188 in the third term must be modified accordingly (See ATC-7, Applied technology Council, 1981).

This formula was developed based on engineering principles and monotonic testing. Therefore, it provides an estimate of diaphragm deflection due to loads applied in the factored resistance shear range. The effects of cyclic loading and resulting energy dissipation may alter the values for nail deformation in the third term as well as chord splice effects of the fourth term, if mechanically-spliced wood chords are used. The formula is not applicable to partially-blocked diaphragms.



**FIGURE C12.4.1-3** Alternate shear wall height-to-width ratio with design for force transfer around openings.

The deflection of a blocked structural-use panel shear wall may be calculated by use of the following formula.

$$\Delta = \frac{8v h^3}{wEA} + \frac{v h}{Gt} + 0.75h e_n + \frac{h}{w} d_a$$

where:

$\Delta$  = the calculated deflection, in millimeters, or inches.

$v$  = maximum shear due to factored design loads at the top of the wall, in kilonewtons per meter, or pounds per lineal foot.

$h$  = shear wall height, in meters, or feet.

$w$  = shear wall width, in meters, or feet.

$E$  = elastic modulus of boundary element (vertical member at shear wall boundary), in megapascals, or pounds per square inch.

$A$  = area of boundary element cross-section (vertical member at shear wall boundary), in square millimeters, or square inches.

$Gt$  = panel rigidity through the thickness, in Newtons per millimeter, or pounds per inch.

$e_n$  = nail deformation, in millimeters, or inches.

$d_a$  = deflection due to anchorage details (rotation and slip at hold downs), in millimeters, or inches.

Guidance for use of the above two equations can be found in References 12-2, 12-3, and 12-4, and ATC-7 (Applied Technology Council, 1981).

The capacity of shear walls shall be determined either from tabulated values that are based on experimental results or from standard principles of mechanics. The tables of allowable values for shear walls sheathed with other than wood or wood-based structural-use panels were eliminated in the 1991 *Provisions* as a result of re-learning the lessons from past earthquakes and testing on the performance of structures sheathed with these materials during the Northridge earthquake. The values for capacity for shear walls sheathed with wood-based structural-use panels have been reduced from monotonic test values by 10 percent to account for the reduction in capacity observed during cyclic tests. Capacities for diaphragms were not reduced from the monotonic test values because the severe damage that occurred in shear walls has not been noted in diaphragms in recent earthquakes.

One stipulation is that there are no accepted rational methods for calculating deflections for diaphragms and shear walls that are sheathed with materials other than wood-based structural-use panel products fastened with nails. Therefore, if a rational method is to be used, the capacity of the fastener in the sheathing material must be validated by acceptable test procedures employing cyclic forces or displacements. Validation must include correlation between the overall stiffness and capacity predicted by principles of mechanics and that observed from test results. A diaphragm or shear wall sheathed with dissimilar materials on the two faces should be designed as a single-sided wall using the capacity of the stronger of the materials and ignoring the weaker of the materials.

The *Provisions* are based on assemblies having energy dissipation capacities which were recognized in setting the  $R$  factors. For diaphragms and shear walls utilizing wood framing, the energy dissipation is almost entirely due to nail bending. Fasteners other than nails and staples have not been extensively tested under cyclic load application. When screws or adhesives have been tested in assemblies subjected to cyclic loading, they have had a brittle mode of failure. For this reason, adhesives are prohibited for wood framed shear wall assemblies and only the tabulated values for nailed or stapled sheathing are recommended. Analysis and design of shear wall sheathing applied with adhesives is beyond the scope of the *Provisions*. If one wished to use shear wall sheathing attached with adhesives, as an alternate method of construction in accordance with Sec. 1.2.5, caution should be used (Dolan and White, 1992; Foschi and Filiatrault, 1990). The increased stiffness will result in larger forces being attracted to the structure. The anchorage connections and adjoining assemblies must, therefore, be designed for these increased forces. Due to the brittle failure mode, these walls should be designed to



remain elastic, similar to unreinforced masonry. The use of adhesives for attaching sheathing for diaphragms increases their stiffness, and could easily change the diaphragm response from flexible to rigid.

**12.4.2 Shear Resistance Based on Principals of Mechanics:** Discussion of cyclic test protocol is included in ATC (1995), Dolan (1996), and Rose (1996).

**12.4.3 Sheathing Requirements:** Sheathing nails should be driven flush with the surface of the panel, and not further. This could result in the nail head creating a small depression in, but not fracturing, the first veneer. This requirement is imposed because of the significant reduction in capacity and ductility observed in shear walls constructed with over-driven nails. It is advised that the edge distance for sheathing nails be increased as much as possible along the bottom of the panel to reduce the potential for the nails to pull through the sheathing.

**12.4.3.3 and 12.4.3.4 Single and Double Diagonally Sheathed Lumber Diaphragms and Shear Walls:** Diagonally sheathed lumber diaphragms and shear walls are presented in the *Provisions* because they are still used for new construction in some regions. The 1994 *Provisions* contain allowable stress design values. The design values in the 1997 *Provisions* are expressed in terms of the factored shear resistance ( $\lambda\phi D$ ) in order to provide consistency with the tables for structural-use panels. The factored shear resistance is based on a soft conversion from the model code allowable stress loads and capacities to *Provisions* strength loads for regions with high effective peak accelerations. This will allow users in the western states, where this construction is currently being used, to continue with little or no change in requirements; at the same time, reasonable values are provided for regions with lower effective peak accelerations.

**12.5 CONVENTIONAL LIGHT-FRAME CONSTRUCTION:** These provisions intend that a structure using conventional construction methods and complying with the requirements of this section be deemed capable of resisting the seismic forces imposed by the *Provisions*. Repetitive framing members such as joists, rafters, and studs together with sheathing and finishes comprise conventional light-frame construction. The subject of conventional construction is addressed in each of the model codes. It is acknowledged and accepted that, for the most part, the conventional construction provisions in the model codes concerning framing members and sheathing that carry gravity loads are adequate. This is due to the fact that the tables in the model codes giving allowable spans have been developed using basic principles of mechanics. For seismic lateral force resistance, however, experience has shown that additional requirements are needed.

To provide lateral force resistance in vertical elements of structures, wall bracing requirements have been incorporated in conventional construction provisions of the model codes. With a few exceptions, these generally have been adequate for single family residences for which conventional construction requirements were originally developed. While the model building codes have been quite specific as to the type of bracing materials to be used and the amount of bracing required in any wall, no limits on the number or maximum separation between braced walls have been established. This section of the *Provisions* introduces the concept of mandating the maximum spacing of braced wall lines. By mandating the maximum spacing of braced wall lines and thereby limiting the lateral forces acting on these vertical elements, these revisions provide for a lateral-force-resisting system that will be less prone to overstressing and that can be applied and enforced more uniformly than previous model building code requirements. While specific elements of light-frame construction may be calculated to be

overstressed, there is typically a great deal of redundancy and uncounted resistance in such structures and they have generally performed well in past earthquakes. The experience in the Northridge earthquake was, however, less reassuring, especially for those residences relying on gypsum board or stucco for lateral force resistance. The light weight of conventional construction, together with the large energy dissipation capacity of the multiple fasteners used and inherent redundancy of the system are major factors in the observed good performance where wood or wood-based panels were used.

The scope of this section specifically excludes prescriptive design of structures with concrete or masonry walls above the basement story, with the exception of veneer, in order to maintain the light weight of construction that the bracing requirements are based on. Wood braced wall panels and diaphragms as prescribed in this section are not intended to support lateral forces due to masonry or concrete construction. Prescriptive (empirical) design of masonry walls is allowed for in Chapter 11; however, design of structures combining masonry wall construction and wood roof and floor diaphragm construction must have an engineered design. In regions of high seismic activity, past earthquakes have demonstrated significant problems with structures combining masonry and wood construction. While engineered design requirements do address these problems, the prescriptive requirements in the model codes do not adequately address these problems. Masonry and concrete basement walls are permitted to be constructed in accordance with the requirements of Ref. 12-5.

**12.5.1.1 Irregular Structures:** This section was added to the 1997 *Provisions* to clarify the definition of irregular (unusually shaped) structures that would require the structure to be designed for the forces prescribed in Chapter 5 in accordance with the requirements of Sec. 12.3 and 12.4. The descriptions and diagrams provide the registered design professional with several typical irregularities that produce torsional response, or result in forces considered high enough to require an engineered design and applies only to Seismic Design Category C and D structures.

Structures with geometric discontinuities in the lateral force resisting system have been observed to sustain more earthquake and wind damage than structures without discontinuities. They have also been observed to concentrate damage at the discontinuity location. For Seismic Design Categories C and D, this section translates applicable irregularities from Tables 5.2.3.2 and 5.2.3.3 into limitations on conventional light-frame construction. When a structure falls within the description of irregular, it is required that either the entire structure or the non-conventional portions be engineered in accordance with the engineered design portions of these *Provisions*. The irregularities are based on similar model code requirements. While conceptually these are equally applicable to all Seismic Design Categories, they are more readily accepted in areas of high seismic risk, where damage due to irregularities has repeatedly been observed.

The engineered design of non-conventional portions in lieu of the entire structure is a common practice in some regions. The registered design professional is left to judge the extent of the portion to be designed. This often involves design of the nonconforming element, force transfer into the element, and a load path from the element to the foundation. A nonconforming portion will sometimes have enough of an impact on the behavior of a structure to warrant that the entire lateral-force-resisting system receive an engineered design.

**12.5.1.1.1:** This limitation is based on Item 4 of Table 5.2.3.3 and applies when braced wall panels are offset out-of-plane from floor to floor. In-plane offsets are discussed in another item. Ideally braced

wall panels would always stack above of each other from floor to floor with the length stepping down at upper floors as less length of bracing is required.

Because cantilevers and set backs are very often incorporated into residential construction, the exception offers rules by which limited cantilevers and setbacks can be considered conventional. Floor joists are limited to 2 by 10 (actual 1½ by 9¼ in., 38 by 235 mm) or larger and doubled at braced wall panel ends in order to accommodate the vertical overturning reactions at the end of braced wall panels. In addition the ends of cantilevers are attached to a common rim joist to allow for redistribution of load. For rim joists that cannot run the entire length of the cantilever, the metal tie is intended to transfer vertical shear as well as provide a nominal tension tie. Limitations are placed on gravity loads to be carried by cantilever or setback floor joists so that the joist strength will not be exceeded. The roof loads discussed are based on the use of solid sawn members where allowable spans limit the possible loads. Where engineered framing members such as trusses are used, gravity load capacity of the cantilevered or setback floor joists should be carefully evaluated.

**12.5.1.1.2:** This limitation is based in Item 1 of Table 5.2.3.2, and applies to open-front structures or portions of structures. The conventional construction bracing concept is based on using braced wall lines to divide a structure up into a series of boxes of limited dimension, with the seismic force to each box being limited by the size. The intent is that each box be supported by braced wall lines on all four sides, limiting the amount of torsion that can occur. The exception, which permits portions of roofs or floors to extend past the braced wall line, is intended to permit construction such as porch roofs and bay windows. Walls with no lateral resistance are allowed in areas where braced walls are prohibited.

**12.5.1.1.3:** This limitation is based on Item 4 of Table 5.2.3.3 and applies when braced wall panels are offset in-plane. Ends of braced wall panels supported on window or door headers can be calculated to transfer large vertical reactions to headers that may not be of adequate size to resist these reactions. The exception permits a 1 foot extension of the braced wall panel over a 4 by 12 (actual 3½ by 11¼ in., 89 by 286 mm) header on the basis that the vertical reaction is within a 45 degree line of the header support and therefore will not result in critical shear or flexure. All other header conditions require an engineered design. Walls with no lateral resistance are allowed in areas where braced walls are prohibited.

**12.5.1.1.4:** This limitation results from observation of damage that is somewhat unique to split-level wood frame construction. If floors on either side of an offset move in opposite directions due to earthquake or wind loading, the short bearing wall in the middle becomes unstable and vertical support for the upper joists can be lost, resulting in a collapse. If the vertical offset is limited to a dimension equal to or less than the joist depth, then a simple strap tie directly connecting joists on different levels can be provided, and the irregularity eliminated. *CABO One- and Two-Family Dwelling Code* Sec. 502.4.1 provides requirements for tying of floor joists.

**12.5.1.1.5:** This limitation is based on Item 5 of Table 5.2.3.3 and applies to nonperpendicular braced wall lines. When braced wall lines are not perpendicular to each other, further evaluation is needed to determine force distributions and required bracing.

**12.5.1.1.6:** This limitation is based on Item 3 of Table 5.2.3.2 and attempts to place a practical limit on openings in floors and roofs. Because stair openings are essential to residential construction and have long been used without any report of life-safety hazards resulting, these are felt to be acceptable conventional construction. See Sec. 12.5.3.7 for detailing requirements for permitted openings.

**12.5.1.1.7:** This limits a condition that can cause a torsional irregularity per Item 1 of Table 5.2.3.2. Where heights of braced wall panels vary significantly, distribution of lateral forces will also vary. If a structure on a hill is supported on 2 foot high braced cripple wall panels on one side and 8 foot high panels on the other, torsion and redistribution of forces will occur. An engineered design for this situation is required in order to evaluate force distribution and provide adequate wall bracing and anchor bolting. This limitation applies specifically to walls from the foundation to the floor. While gable-end walls have similar variations in wall heights, this has not been observed to be a significant concern in conventional construction. See Sec. 12.5.3.6 for detailing requirements for permitted foundation stepping.

**12.5.2.1 Spacing Between Braced Wall Lines:** Table 12.5.1-1 prescribes the spacing of braced wall lines and number of stories permitted for conventional construction structures. Figures C12.5.2.1-1 and C12.5.2.1-2 illustrate the basic components of the lateral bracing system. Information in Tables 12.5.1-1 and 12.5.2-1 was first included in the 1991 Edition.

**12.5.2.2 Braced Wall Line Sheathing Requirements:** Table 12.5.2-1 prescribes the minimum length of bracing along each 25 ft (7.6 m) length of braced wall line. (See *Commentary* Sec. 12.4 regarding adhesive attachment.) Total height of structures has been reduced to limit overturning of the braced walls so that significant uplift is not generally encountered. The height limit will accommodate 8 to 10 ft (2.4 to 3 m) story heights.

**12.5.3 DETAILING REQUIREMENTS:** The intent of this section is to rely on the traditional light-frame conventional construction materials and fastenings as prescribed in the references for this chapter. Braced wall panels are not required to be aligned vertically or horizontally (within the limits prescribed in Sec. 12.5.1.1) but stacking is desirable where possible. With the freedom provided for non-alignment it becomes important that a load path be provided to transfer lateral forces from upper levels through intermediate vertical and horizontal resisting elements to the foundation. Connections between horizontal and vertical resisting elements are prescribed. In structures two or three stories in height, it is desirable to have interior braced wall panels supported on a continuous foundation. See Figures C12.5.3-1 through C12.5.3-11 for examples of connections.

The 1997 *Provisions* incorporates some of the wall anchorage, top plate, and braced wall panel connection requirements from the model building codes. These are included for completeness of the document and to clarify the requirement for the registered design professional. Additional requirements for foundations supporting braced wall panels has also been added to provide guidance and clarity for the registered design professional.

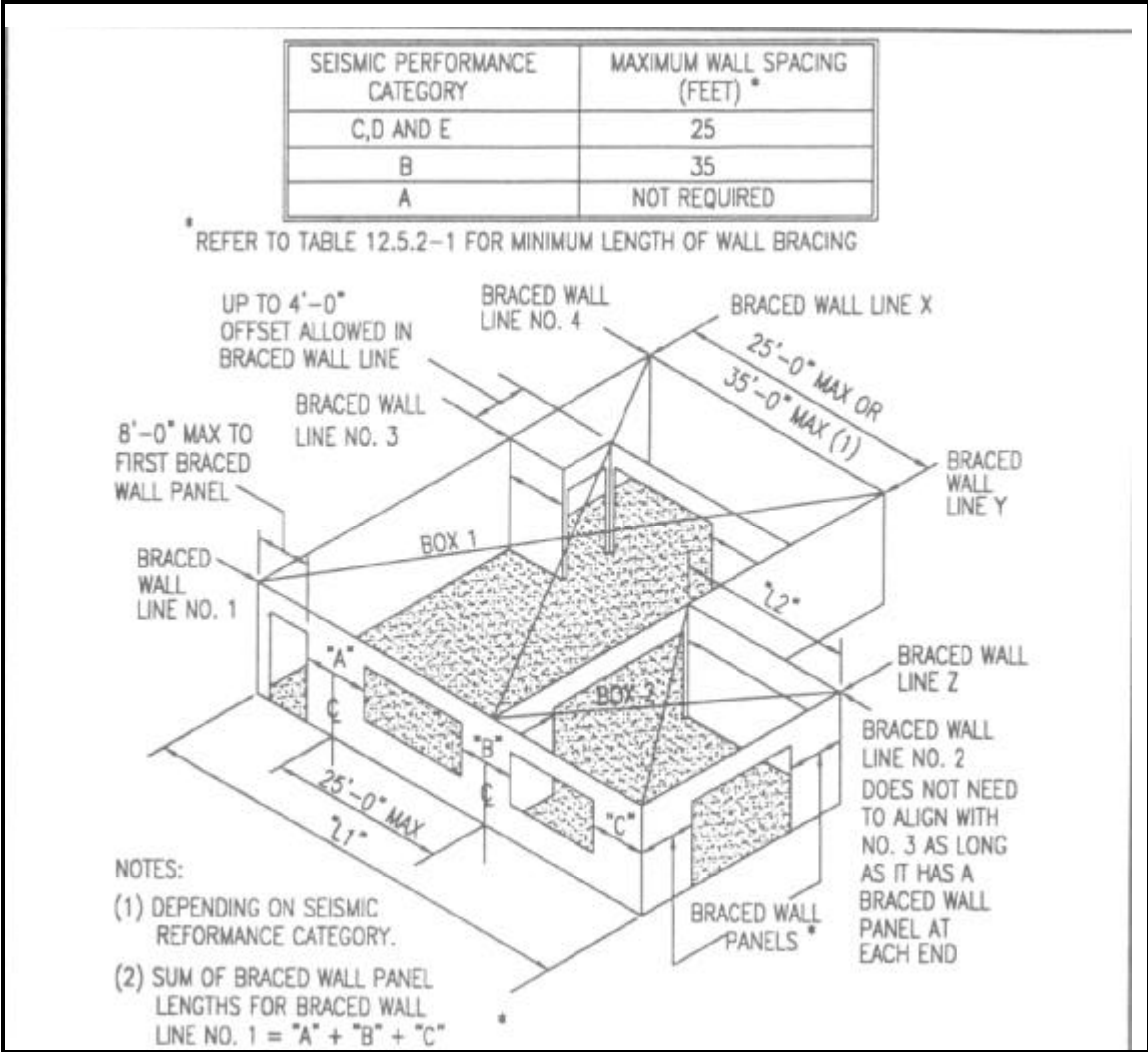

FIGURE C12.5.2.1-1 Acceptable one-story bracing example.

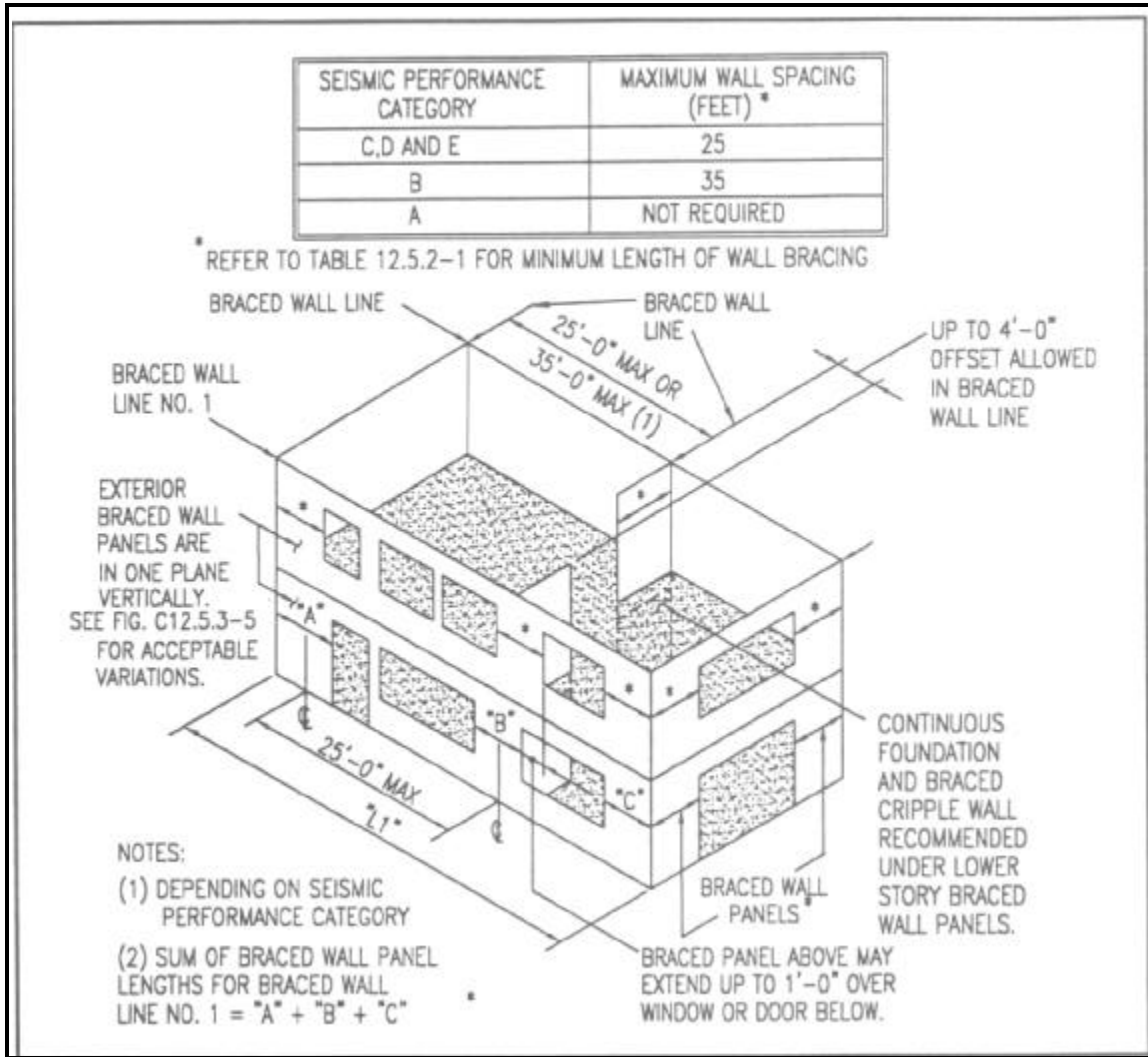

FIGURE C12.5.2.1-2 Acceptable two-story bracing example.

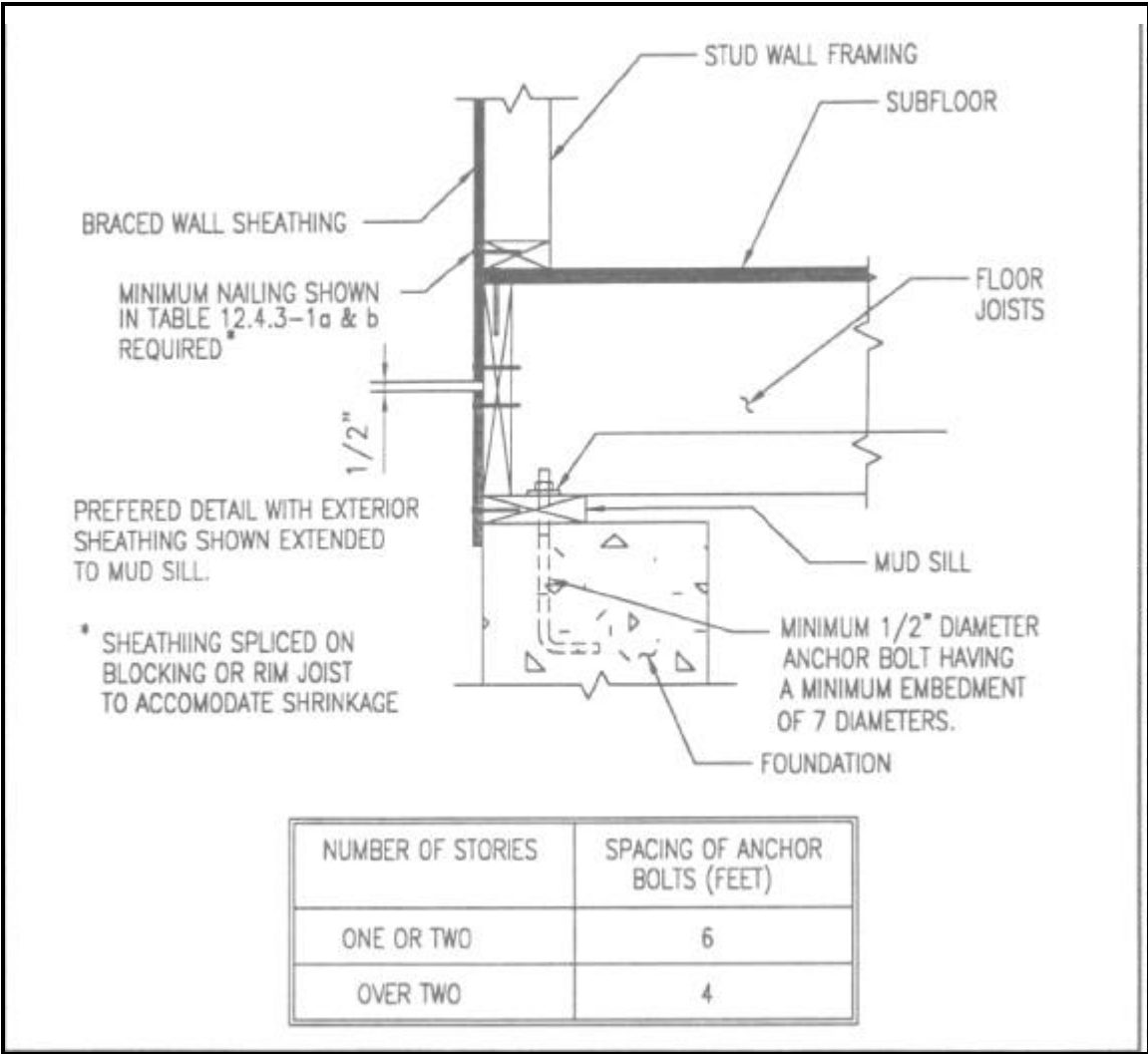

FIGURE C12.5.3-1 Wall anchor detail.

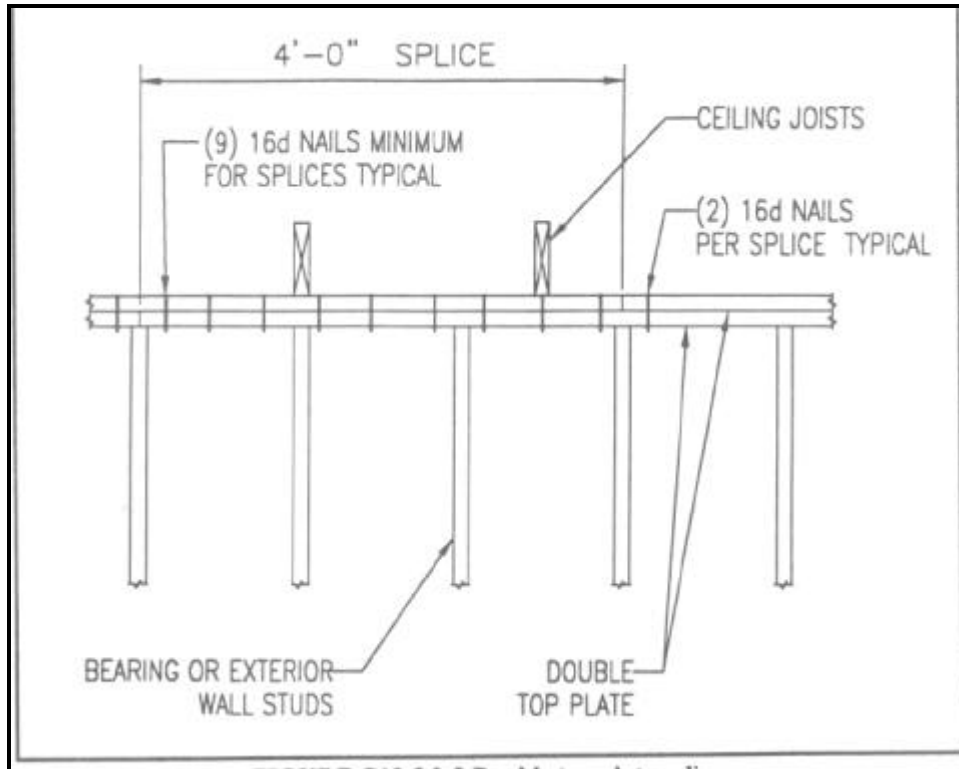

FIGURE C12.5.3-2 Double top plate splice.



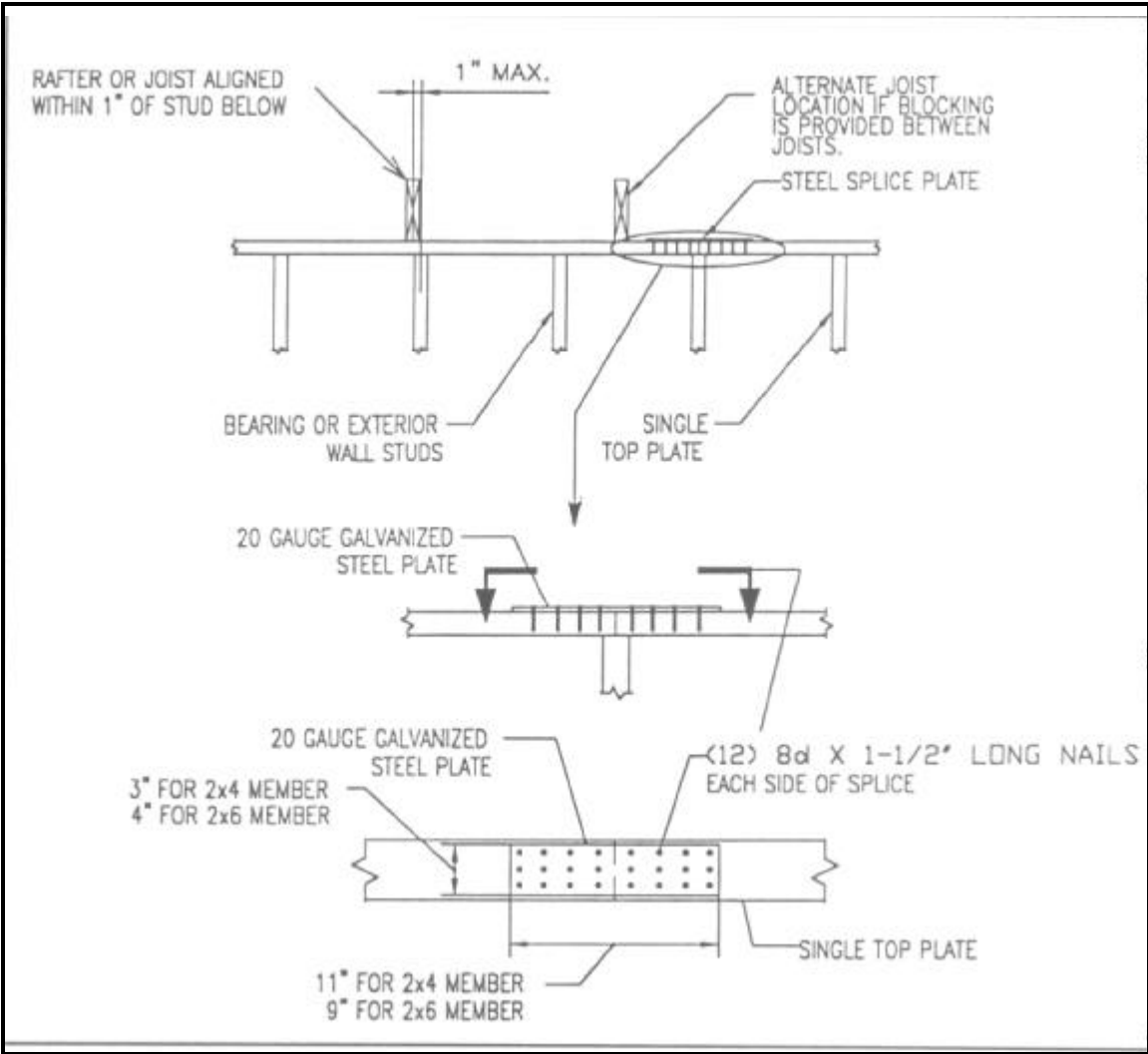

FIGURE C12.5.3-3 Single top plate splice.

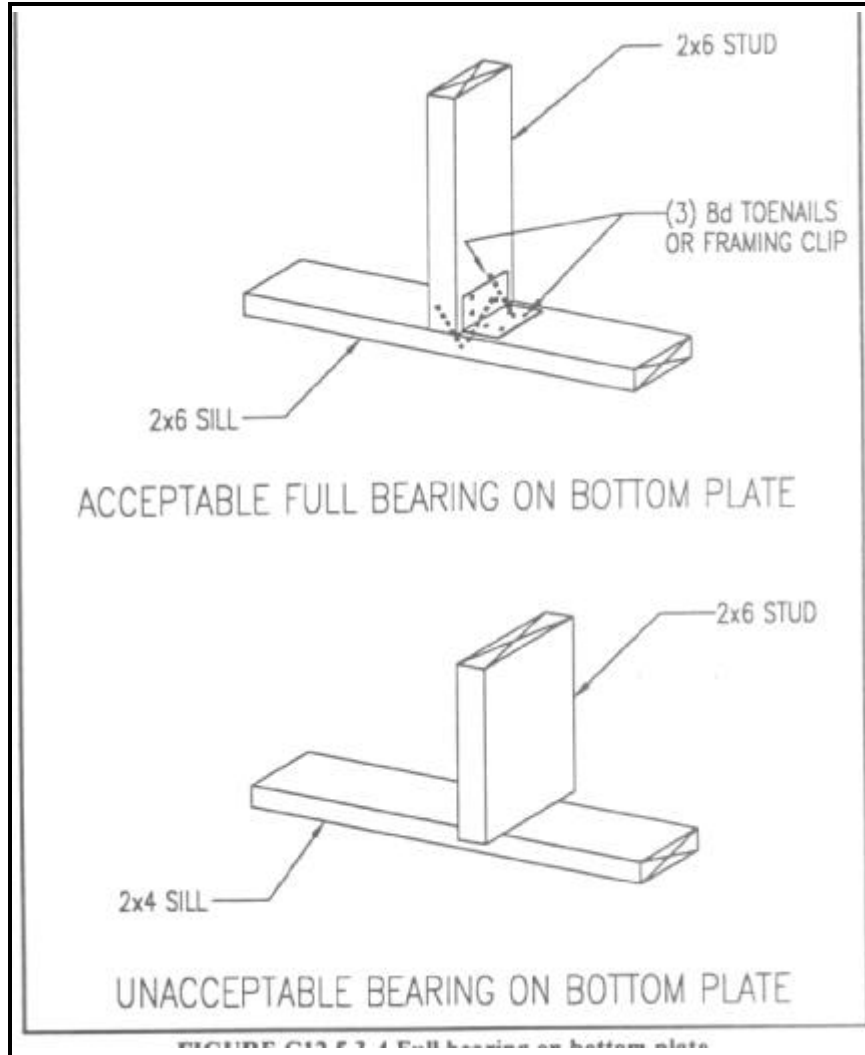

FIGURE C12.5.3-4 Full bearing on bottom plate.

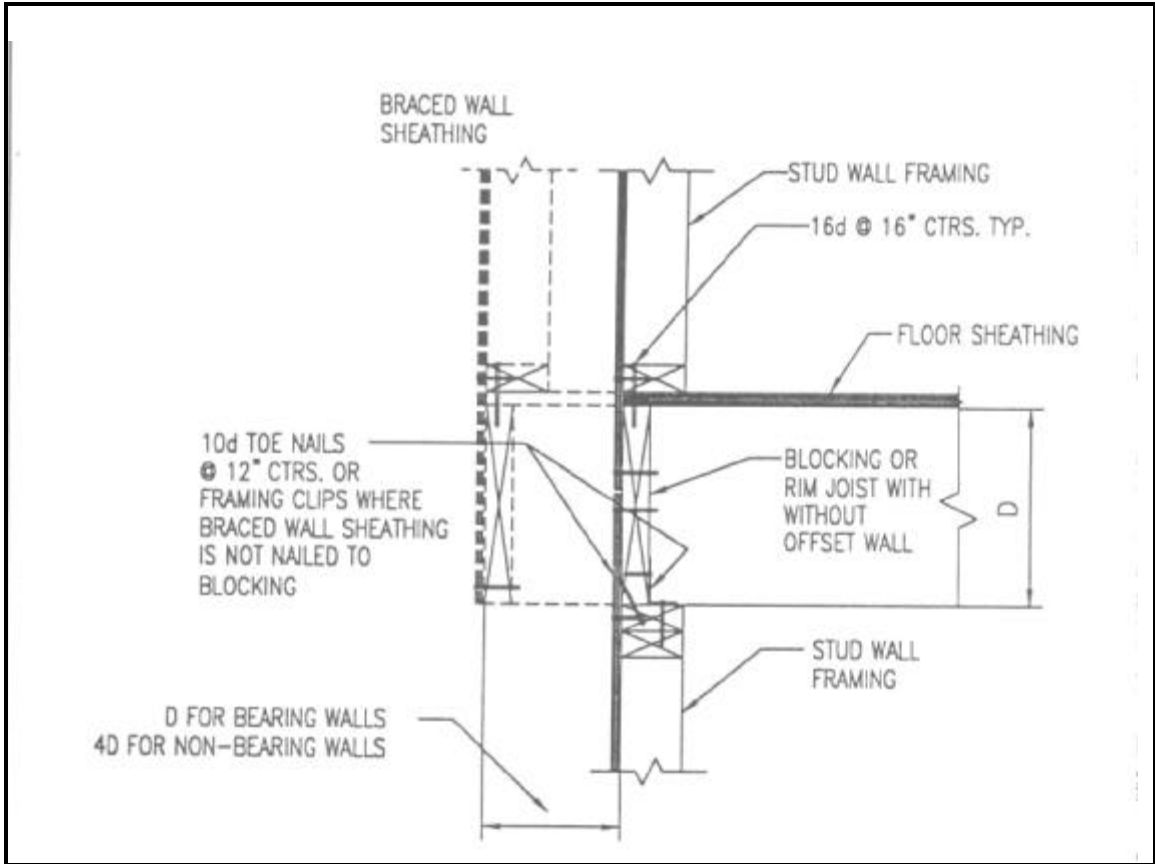

FIGURE C12.5.3-5 Exterior braced wall.

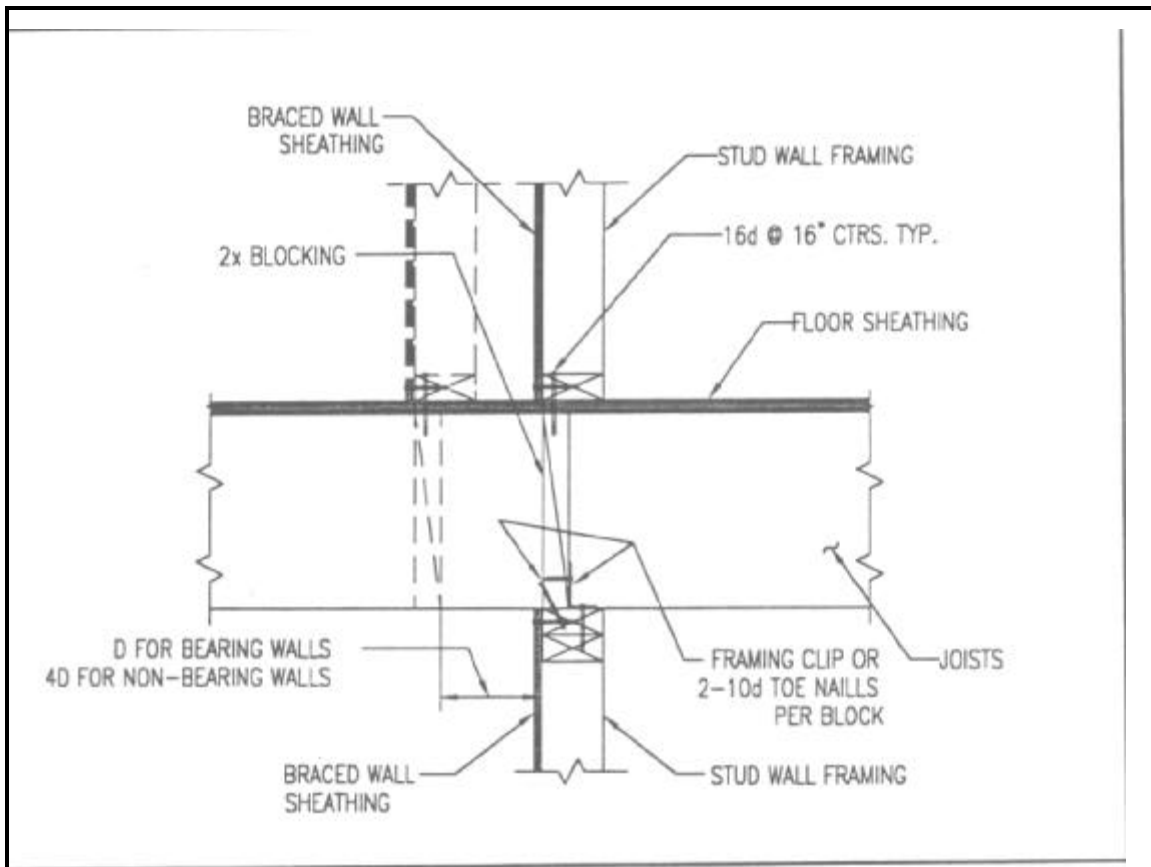

FIGURE C12.5.3-6 Interior braced wall at perpendicular joist.

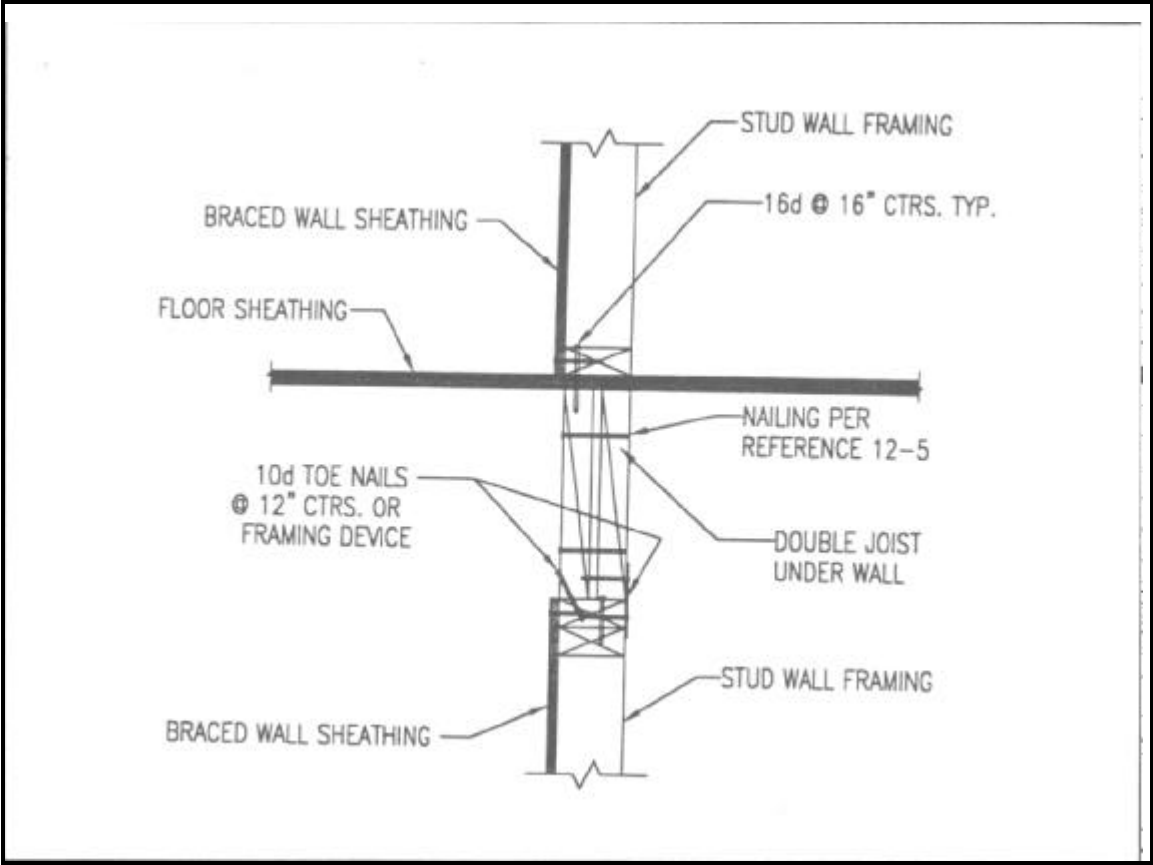

FIGURE C12.5.3-7 Interior braced wall at parallel joist.

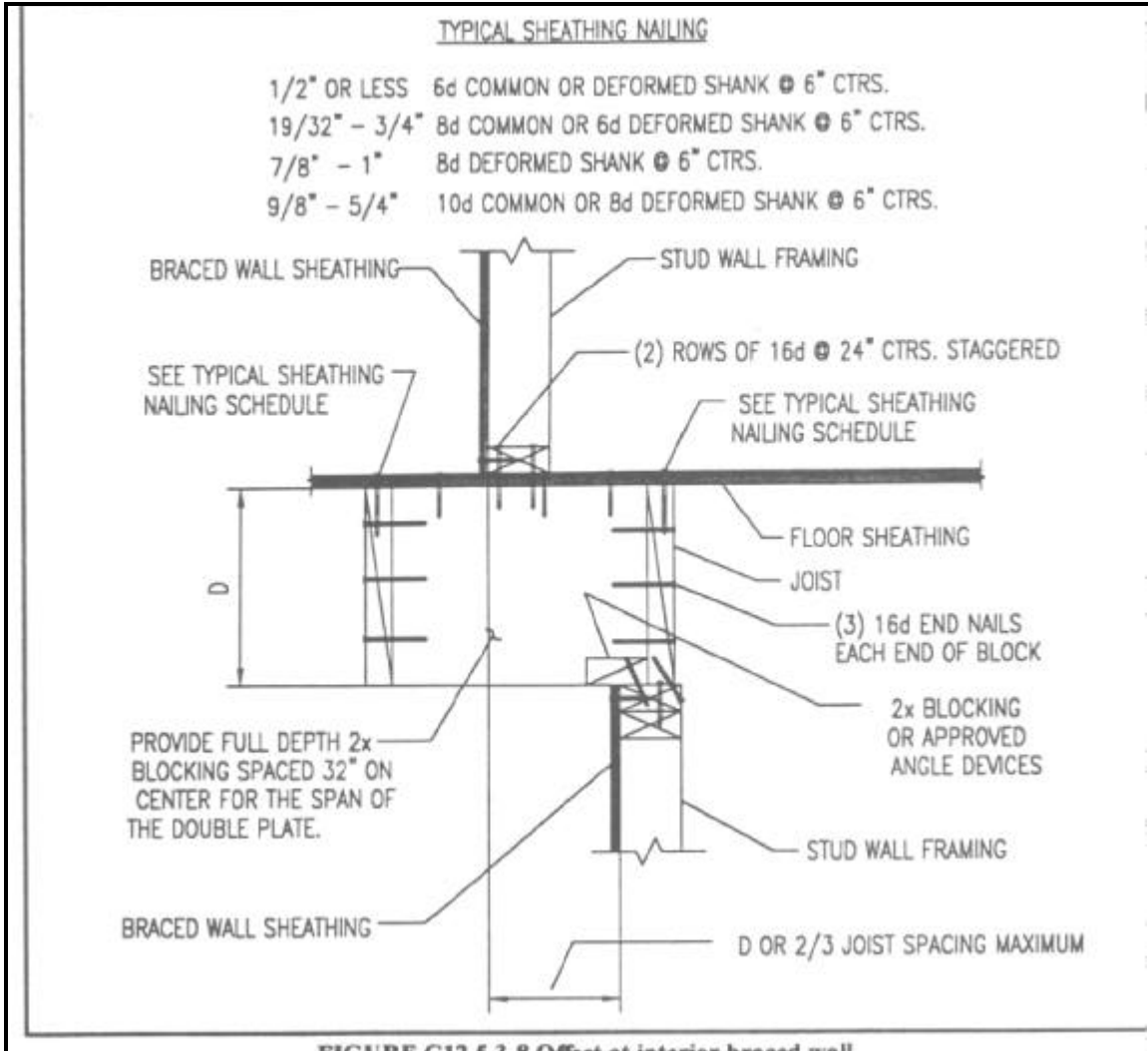

FIGURE C12.5.3-8 Offset at interior braced wall.

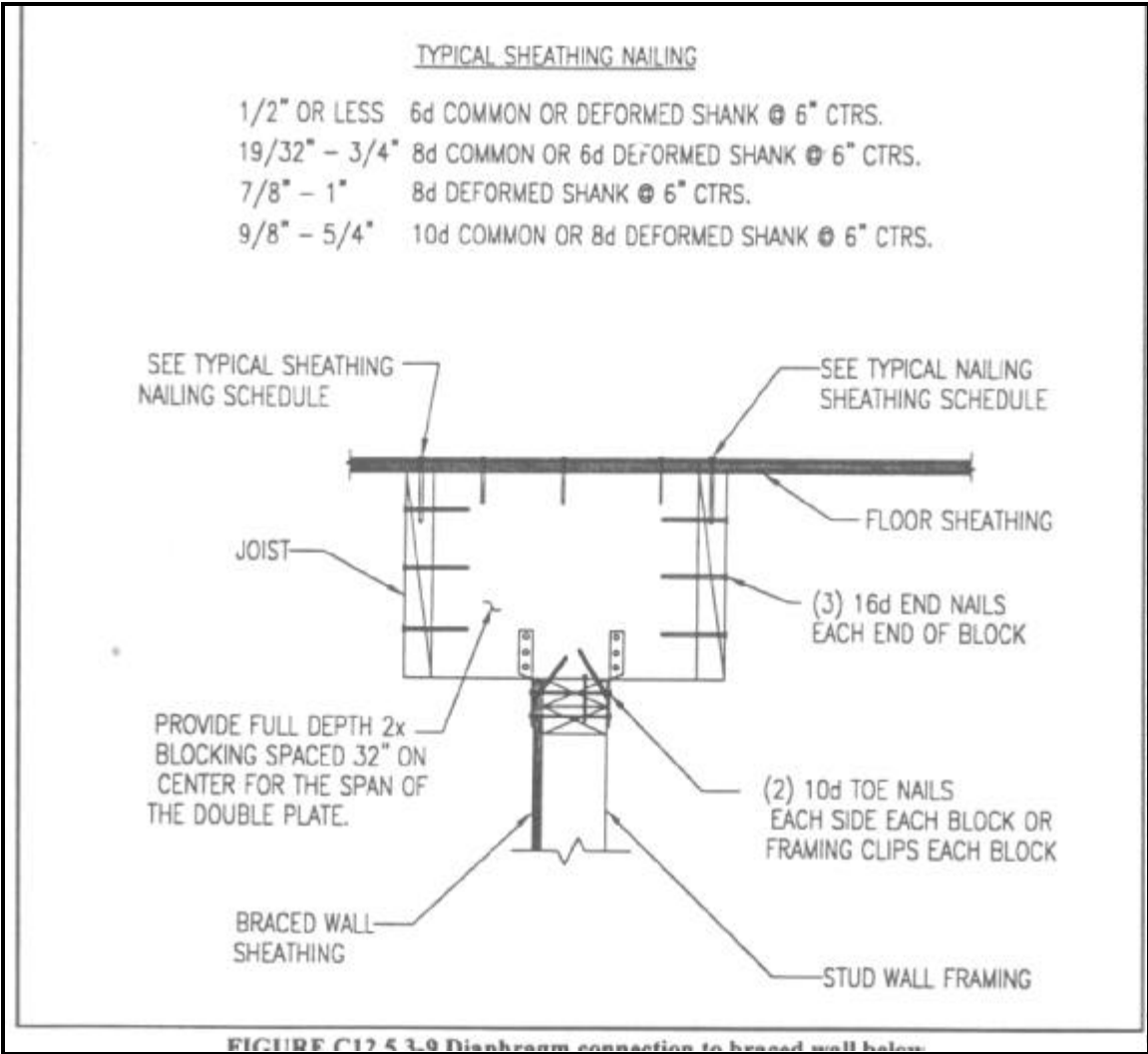

FIGURE C12.5.3-9 Diaphragm connection to braced wall below.

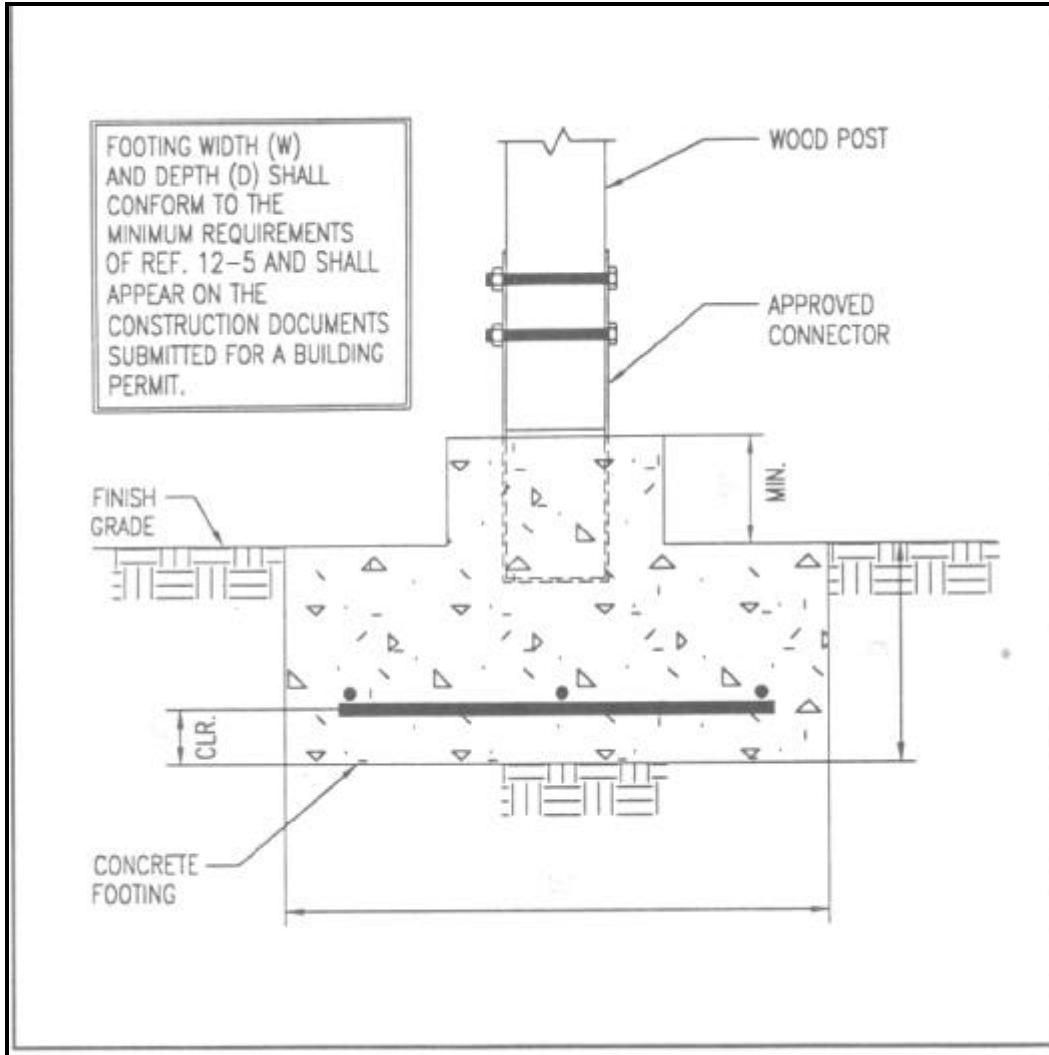

FIGURE C12.5.3-10 Post base detail.



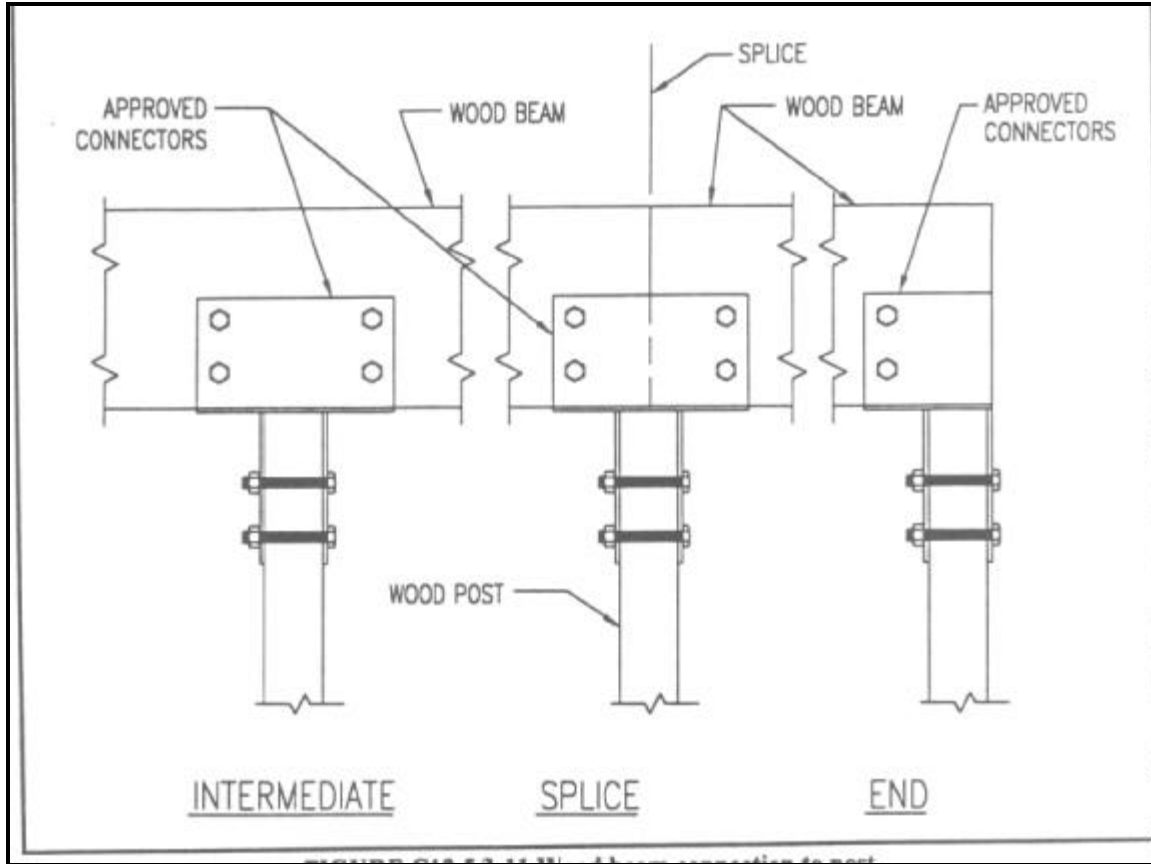

FIGURE C12.5.3-11 Wood beam connection to post.

**12.5.3.1 Braced Wall Panel Connections:** The exception provided in this section of the *Provisions* is included due to the difficulty in providing a mechanism to transfer the diaphragm loads from a truss roof system to the braced wall panels of the top story. This problem has been considered by the Clackamas County, Oregon Building Codes Division, and an alternate to the CABO Building Code Sec. 402.10 was written in 1993, and revised September 5, 1995. The details shown in Figure C12.5.3.1-1 through C12.5.3.1-4 are provided as suggested methods for providing positive transfer of the lateral forces from the diaphragm through the web sections of the trusses to the top of the braced wall panels below.

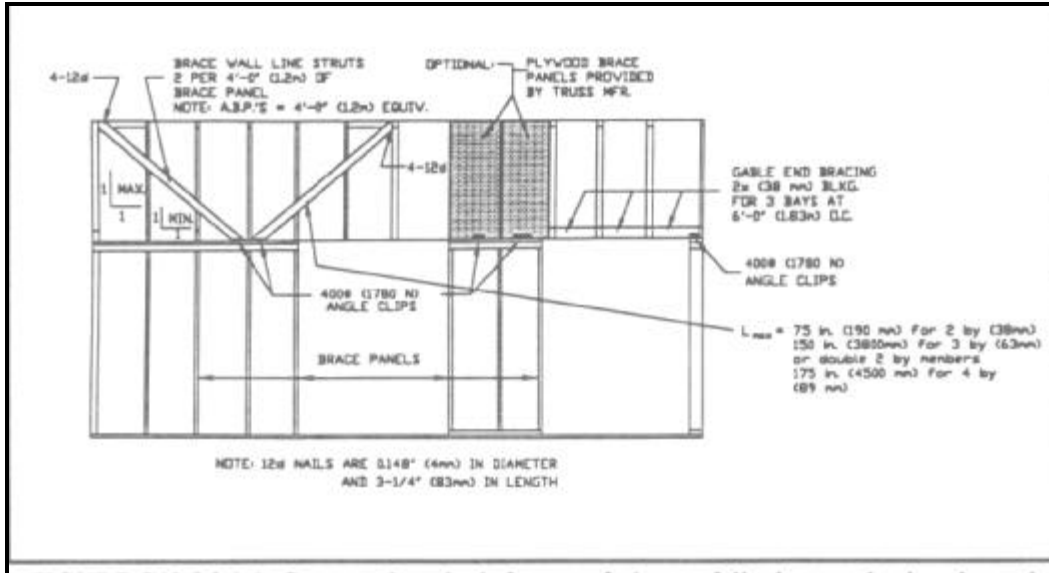

FIGURE C12.5.3.1-1. Suggested methods for transferring roof diaphragm loads to braced wall panels.

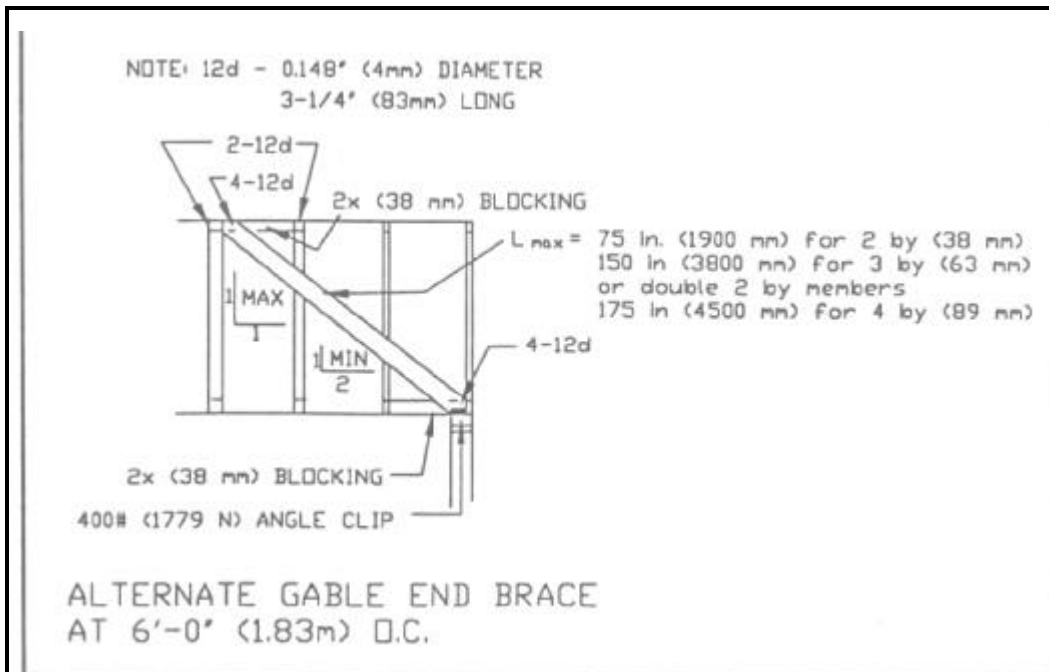

FIGURE C12.5.3.1-2. Alternate gable end brace.

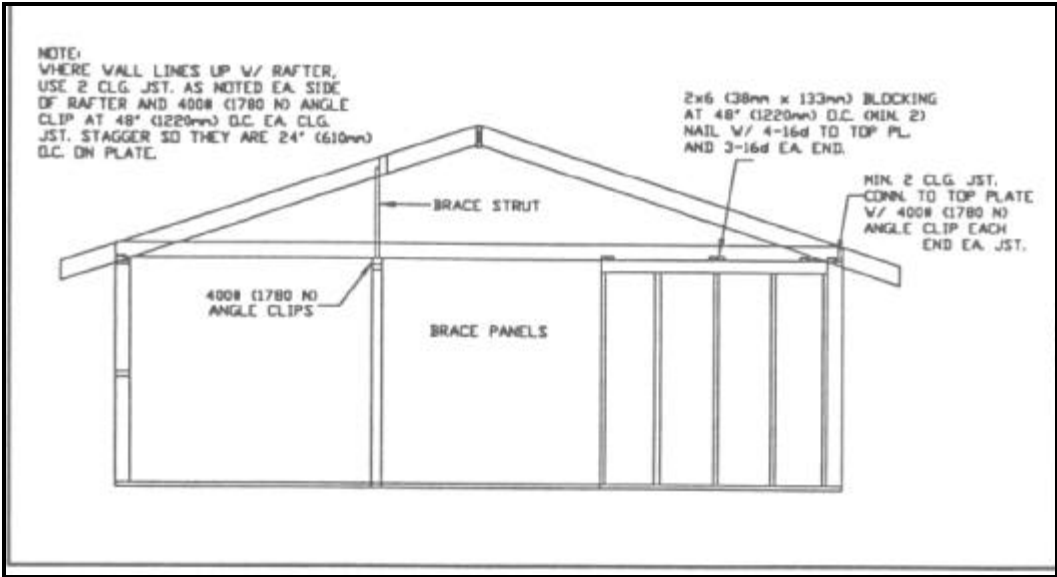

FIGURE C12.5.3.1-3 Wall parallel to truss bracing detail.

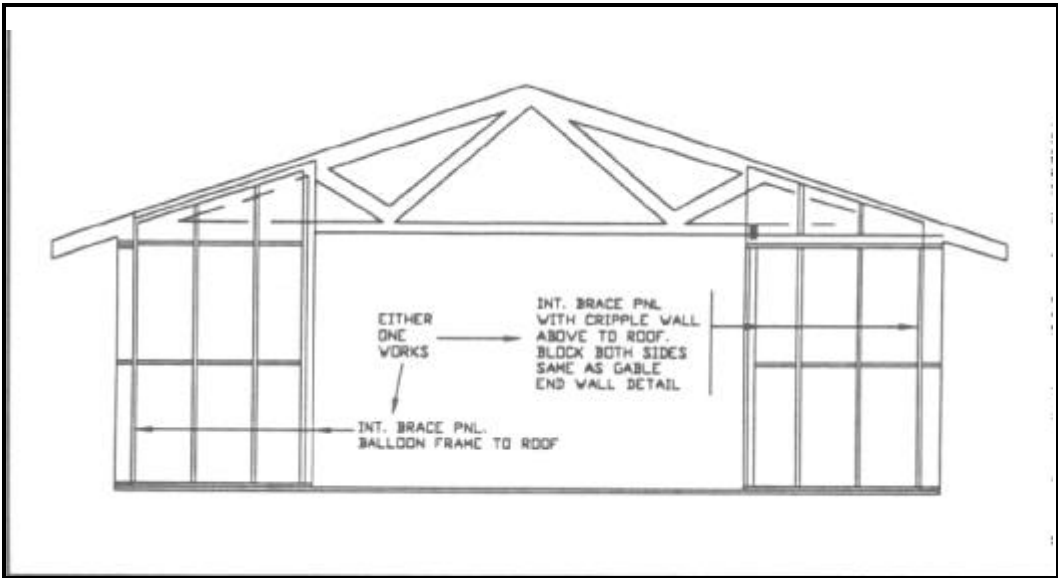

FIGURE C12.5.3.1-4 Wall parallel to truss alternate bracing detail.

**12.6 SEISMIC DESIGN CATEGORY A:** Wood frame structures assigned to Seismic Design Category A, other than one- and two-family dwellings, must conform with Sec. 12.5 or if engineered need only comply with the reference documents and Sec. 5.2.6.1.2. Exceptions addressing one- and two-family detached dwellings appear in Sec. 1.2.1.

**12.7 SEISMIC DESIGN CATEGORIES B, C, AND D:** In the 1997 *Provisions*, Seismic Design Categories B, C, and D, have been combined. At the same time, subsections on material limitations and anchorage requirements have been moved to Sec. 12.3 and 12.4. This was based on the philosophy that detailing requirements should vary based on *R* values, not Seismic Design Categories. Other changes made in the 1997 *Provisions* were editorial (i.e., for clarification or consistency).

Structures assigned to Seismic Design Categories B, C, and D are required to meet the minimum construction requirements of Sec. 12.5 (Sherwood and Stroh, 1989) or must be engineered using standard design methods and principles of mechanics. Conventional light-frame construction requirements were modified in the 1991 *Provisions* to limit the spacing between braced wall lines based on calculated capacities to resist the loads and forces imposed.

Engineered structures assigned to Seismic Design Categories B, C, and D are required to conform to the provisions of Sec. 12.3, Engineered Wood Construction, and Sec. 12.4, Diaphragms and Shear Walls. Included in these sections are general design limitations, limits on wood resisting forces contributed by concrete or masonry, shear wall and diaphragm aspect ratio limitations, and requirements for distribution of shear to vertical resisting elements. See *Commentary* Sec. 12.3 and 12.4.

In the 1997 *Provisions*, Sec. 12.4.1 has been modified to improve the clarity and enforceability of the *Provisions*. The requirements for Seismic Design Categories C and D were moved into the same section as Seismic Design Category B with the triggers for restrictions such as materials limitations associated with Seismic Design Categories C and D being moved to Sections 12.3 and 12.4.

**12.8 SEISMIC DESIGN CATEGORIES E and F:** Seismic Design Category F structures require an engineered design. Conventional construction is not considered rigorous enough for structures expected to be functional following a major seismic event. For Seismic Design Category E and F structures, close attention to load path and detailing is required.

Structures assigned to Seismic Design Category E and F require blocked diaphragms. Structural-use panels must be applied directly to the framing members; the use of gypsum wallboard between the structural-use panels and the framing members is prohibited because of the poor performance of nails in gypsum. Restrictions on allowable shear values for structural-use shear panels when used in conjunction with concrete and masonry walls are intended to provide for deformation compatibility of the different materials.

Changes made in the 1997 *Provisions* to this section were to provide consistent terminology or were additions taken from the LRFD standard.

## REFERENCES

American Institute of Timber Construction. 1994. *Timber Construction Manual*. New York, New York: John Wiley and Sons, Inc.

- American Forest & Paper Association. 1991. *ANSI/NFoPA NDS-1991. National Design Specification for Wood Construction*. Washington, D.C.: AF&PA.
- American Forest & Paper Association. 1996. *Manual of Wood Construction: Load and Resistance Factor Design (LRFD)*. Washington, D.C.: AF&PA.
- American Plywood Association. 1991. *Design/Construction Guide--Diaphragms*. Tacoma, Washington: APA.
- American Plywood Association. 1994. *Northridge California Earthquake, T94-5*. Tacoma, Washington.: APA.
- American Plywood Association. 1996. *Proposed Cyclic Testing Standard for Shear Walls*. Tacoma, Washington: APA.
- ASCE Committee on Wood Load and Resistance Factor Design for Engineered Wood Construction. 1988. *A Pre Standard Report American Society of Civil Engineers*. New York, New York: ASCE.
- ASCE. 1995. *Standard For Load and Resistance Factor For Engineered Wood Construction*. AF&PA/ASCE 16-95. American Society of Civil Engineers, New York, New York.
- Applied Technology Council. 1981. *Guidelines for the Design of Horizontal Wood Diaphragms*, ATC-7. Redwood City, California: ATC.
- Applied Technology Council. 1995. *Cyclic Testing of Narrow Plywood Shear Walls*, ATC-R-1. Redwood City, California: ATC.
- Breyer, Donald E. 1993. *Design of Wood Structures*, Third Edition. New York, New York: McGraw-Hill Book Company.
- Canadian Wood Council. 1990. *Wood Design Manual*. Ottawa: Canadian Wood Council.
- Canadian Wood Council. 1991. *Wood Reference Handbook*. Ottawa: Canadian Wood Council.
- Council of American Building Officials (CABO). 1995. *One- and Two-Family Dwelling Code*. Country Club Hills, Illinois: BOCA.
- Department of the Army, Navy and Air Force. 1992. *Seismic Design for Buildings*, TM5-809-10 (Tri-Services Manual). Washington, D.C.: U.S. Government Printing Office.
- Dolan, J.D., 1994. "Proposed Test Method for Dynamic Properties of Connections Assembled with Mechanical Fasteners." *ASTM Journal of Testing and Evaluation* 22(6):542-547.
- Dolan, J. D., and M. W. White. 1992. "Design Considerations for Using Adhesives in Shear Walls." *ASCE Journal of Structural Engineering* 118(12):3473-3480.
- Dolan, J. D. and Johnson, A. C. 1996. "Monotonic Tests of Long Shear Walls with Openings" Virginia Polytechnic Institute and State University, Timber Engineering Report No. TE-1996-001. Blacksburg, Virginia: VPISU.
- Dolan, J. D. and Johnson, A. C. 1996. "Cyclic Tests of Long Shear Walls with Openings" Virginia Polytechnic Institute and State University, Timber Engineering Report No. TE-1996-002. Blacksburg, Virginia: VPISU.

Earthquake Engineering Research Institute. 1996. Northridge earthquake reconnaissance report, Chapter 6, Supplement C to Volume 11, pp 125 et seq., *Earthquake Spectra*.

Faherty, Keith F., and T. G. Williamson. 1989. *Wood Engineering and Construction Handbook*. New York, New York: McGraw-Hill.

U.S. Department of Housing and Urban Development, 1984. *HUD Minimum Property Standards, Vol. I, II, and III*. Washington, D.C.: United States Government Printing Office.

Forest Products Laboratory. 1986. *Wood: Engineering Design Concepts*. University Park: Materials Education Council, The Pennsylvania State University.

Foschi, R. O., and A. Filiatrault. 1990. *Performance Evaluation of 3M Scotch Grip Wood Adhesive 5230 for the Static and Dynamic Design of Timber Shear Walls and Diaphragms*, Vancouver: Department of Civil Engineering Report, University of British Columbia.

Goetz, Karl-Heinz, Dieter Hoor, Karl Moehler, and Julius Natterer. 1989. *Timber Design and Construction Source Book: A Comprehensive Guide to Methods and Practice*. New York, New York: McGraw-Hill.

Hoyle and Woeste. 1989. *Wood Technology and Design of Structures*. Iowa State University Press.

International Conference of Building Officials (ICBO). 1994. *Uniform Building Code*. Whittier, California: ICBO.

Keenan, F. J. 1986. *Limit States Design of Wood Structures*. Morrison Hershfield Limited.

Rose, J. D., 1996. Research Report 158. "Preliminary Testing of Wood Structural Panel Shear Walls Under Cyclic (Reversed) Loading." Tacoma, Washington: APA.

Sherwood and Stroh. 1989. "Wood-Frame House Construction" in *Agricultural Handbook 73*. Washington, D.C.: U.S. Government Printing Office.

Somayaji, Shan. 1992. *Structural Wood Design*. St. Paul, Minnesota: West Publishing Co.

Stalnaker, Judith J., and E. C. Harris. 1996. *Structural Design in Wood*, Second Edition. New York, New York: McGraw-Hill.

U.S. Department of Agriculture, National Oceanic and Atmospheric Administration. 1971. *San Fernando, California, Earthquake of February 9, 1971*. Washington, D.C.: NOAA.

White, M. W. and J. D. Dolan, 1996. "Seismic Response of Timber Shear Walls. Part I: Aspect Ratios." Paper submitted for publication in *ASCE Journal of Structural Engineering*.

Additional references are listed in John Peterson. 1983. "Bibliography on Lumber and Wood Panel Diaphragms", *Journal of Structural Engineering*, Vol. 109 No. 12. American Society of Civil Engineers, New York, New York.



## Chapter 13 Commentary

### SEISMICALLY ISOLATED STRUCTURES

Seismic isolation, commonly referred to as base isolation, is a design concept based on the premise that a structure can be substantially decoupled from potentially damaging earthquake motions. By decoupling the structure from the ground motion, the level of response in the structure can be significantly reduced from the level that would otherwise occur in a conventional fixed-base building. Conversely, seismic isolation permits designing with a reduced level of earthquake load to achieve the same degree of seismic protection and reliability as a conventional fixed-base building.

The potential advantages of seismic isolation and the recent advancements in isolation-system products already have led to the design and construction of over 100 seismically isolated buildings and bridges in the United States. A significant amount of research, development, and application activity has occurred over the past 20 years. The following references provide a summary of some of the work that has been performed: Applied Technology Council (1986, 1993), ASCE Structures Congress (1989, 1991, 1993 and 1995), EERI Spectra (1990), Skinner, et al. (1993), U.S. Conference on Earthquake Engineering (1990 and 1994), and World Conference on Earthquake Engineering (1988, 1992 and 1996).

In the mid-1980s, the initial applications identified a need to supplement existing codes with design requirements developed specifically for seismically isolated buildings. Code development work occurred throughout the late 1980s. The status of U.S. seismic isolation design requirements as of October 1996 is as follows:

1. In late 1989, the Structural Engineers Association of California (SEAOC) State Seismology Committee adopted an "Appendix to Chapter 2" of the SEAOC Blue Book entitled, "General Requirements for the Design and Construction of Seismic-Isolated Structures." These requirements were submitted to the International Conference of Building Officials (ICBO) and were adopted by ICBO as an appendix of the 1991 *Uniform Building Code (UBC)*. The isolation appendix of the *UBC* has been updated on an annual basis since that time and the most current version of these regulations may be found in the 1997 *UBC*.
2. In the late 1980s, the *building* Safety Board (BSB) of California, Office of the State Architect, adopted *An Acceptable Method for Design and Review of Hospital Buildings Utilizing Base Isolation* based on recommendations of SEAOC. These methods were used for regulation of California hospitals until the BSB replaced them with the 1991 *UBC* appendix (with slight modification). The current version of these regulations may be found in 1995 *California Building Code*.
3. In 1991 the Federal Emergency Management Agency (FEMA) initiated a 6-year program to develop a set of nationally applicable guidelines for seismic rehabilitation of existing buildings. These guidelines (known as the *NEHRP Guidelines for the Seismic Rehabilitation of*



*Buildings*) are now available as FEMA 273. The design and analysis methods of the *NEHRP Guidelines* parallel closely methods required by the *NEHRP Recommended Provisions* for new buildings, except that more liberal design is permitted for the superstructure of a rehabilitated building.

During development of the 1994 *Provisions*, it was decided to use the latest version (1993 approved changes) of the SEAOC/*UBC* provisions as a basis for the development of the requirements included in the *Provisions*. The only significant changes involved an appropriate conversion to strength design and making the requirements applicable on a national basis. For the 1997 *Provisions*, it was decided to incorporate the latest version of the SEAOC/*UBC* provisions (1997 *UBC*). Since the 1997 *UBC* is now based on strength design, the 1997 *UBC* and the 1997 *Provisions* are almost identical, except for seismic criteria. The seismic criteria of the *Provisions* are based on the new national earthquake maps (developed by the Seismic Design Procedures Group) which can be substantially different from the seismic criteria of the 1997 *UBC*.

A general concern has long existed regarding the applicability of different types of isolation systems. Rather than addressing a specific method of base isolation, the *Provisions* provides general design requirements applicable to a wide range of possible seismic isolation systems. Although remaining general, the design requirements rely on mandatory testing of isolation-system hardware to confirm the engineering parameters used in the design and to verify the overall adequacy of the isolation system. Some systems may not be capable of demonstrating acceptability by test and, consequently, would not be permitted. In general, acceptable systems will: (1) remain stable for required design displacements, (2) provide increasing resistance with increasing displacement, (3) not degrade under repeated cyclic load, and (4) have quantifiable engineering parameters (e.g., force-deflection characteristics and damping).

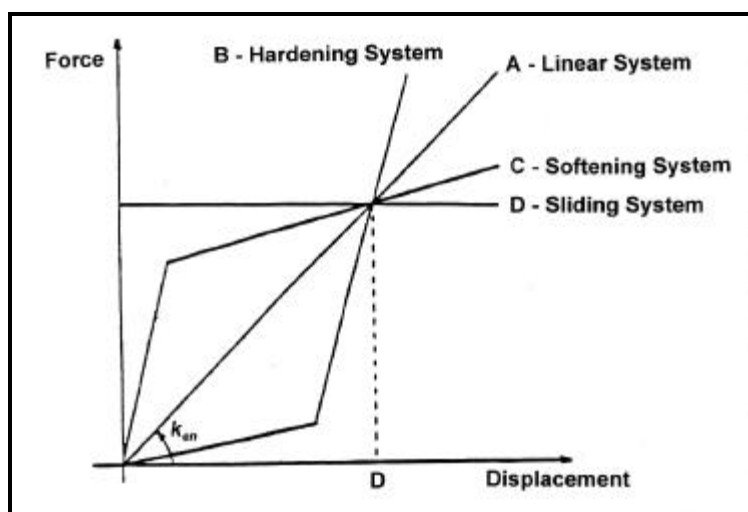

**FIGURE C13** Idealized force-deflection relationships for isolation systems (stiffness effects of sacrificial wind-restraint systems not shown for clarity).

Conceptually, there are four basic types of isolation system force-deflection relationships. These idealized relationships are shown in Figure C13 with each idealized curve having the same design displacement,  $D_D$ , for the design earthquake. A linear isolation system is represented by Curve A and has the same isolated period for all earthquake load levels. In addition, the force generated in the superstructure is directly proportional to the displacement across the isolation system.

A hardening isolation system is represented by Curve B. This system is soft initially (long effective period) and then stiffens (effective period shortens) as the earthquake load level increases. When the earthquake load level induces displacements in excess of the design displacement in a hardening system, the

superstructure is subjected to higher forces and the isolation system to lower displacements than a comparable linear system.

A softening isolation system is represented by Curve C. This system is stiff initially (short effective period) and softens (effective period lengthens) as the earthquake load level increases. When the earthquake load level induces displacements in excess of the design displacement in a softening system, the superstructure is subjected to lower forces and the isolation system to higher displacements than a comparable linear system.

A sliding isolation system is represented by Curve D. This system is governed by the friction force of the isolation system. Like the softening system, the effective period lengthens as the earthquake load level increases and loads on the superstructure remain constant.

The total system displacement for extreme displacement of the sliding isolation system, after repeated earthquake cycles, is highly dependent on the vibratory characteristics of the ground motion and may exceed the design displacement,  $D_D$ . Consequently, minimum design requirements do not adequately define peak seismic displacement for seismic isolation systems governed solely by friction forces.

**13.1 GENERAL:** The design requirements permit the use of one of three different analysis procedures for determining the design-basis seismic loads. The first procedure uses a simple-lateral-force formula (similar to the lateral-force coefficient now used in conventional building design) to prescribe peak lateral displacement and design force as a function of spectral acceleration and isolated-building period and damping. The second and third methods, which are required for geometrically complex or especially flexible buildings, rely on dynamic analysis procedures (either response spectrum or time history) to determine peak response of the isolated building.

The three procedures are based on the same level of seismic input and require a similar level of performance from the building. There are benefits in performing a more complex analysis in that slightly lower design forces and displacements are permitted as the level of analysis becomes more sophisticated. The design requirements for the structural system are based on the design earthquake, a severe level of earthquake ground motion defined as two-thirds of the maximum considered earthquake. The isolation system, including all connections, supporting structural elements and the "gap," is required to be designed (and tested) for 100 percent of maximum considered earthquake demand. Structural elements above the isolation system are not required to be designed for the full effects of the design earthquake, but may be designed for slightly reduced loads (i.e., loads reduced by a factor of up to 2.0) if the structural system has sufficient ductility, etc., to respond inelastically without sustaining significant damage. A similar fixed-base structure would be designed for loads reduced by a factor of 8 rather than 2.

Ideally, lateral displacement of an isolated structure will result, predominantly due to the deformations of the isolation system, rather than in distortion of the structure above. Accordingly, the lateral-load-resisting system of the structure above the isolation system should be designed to have sufficient stiffness and strength to avoid large, inelastic displacements. For this reason, the *Provisions* contains criteria that limit the inelastic response of the structure above the isolation system. Although damage control for the design-basis earthquake is not an explicit objective of the *Provisions*, an isolated structure designed to limit inelastic response of the structural system also will reduce the level of damage that would otherwise occur during an

earthquake. In general, isolated structures designed in conformance with the *Provisions* should be able to:

1. Resist minor and moderate levels of earthquake ground motion without damage to structural elements, nonstructural components, or building contents and
2. Resist major levels of earthquake ground motion without failure of the isolation system, without significant damage to structural elements, without extensive damage to nonstructural components, and without major disruption to facility function.

The above performance objectives for isolated structures considerably exceed the performance anticipated for fixed-base structures during moderate and major earthquakes. Table C13.1 provides a tabular comparison of the performance expected for isolated and fixed-base structures designed in accordance with the *Provisions*. Loss of function is not included in Table C13.1. For certain (fixed-base) facilities, loss of function would not be expected to occur until there is significant structural damage causing closure or restricted access to the building. In other cases, the facility could have only limited or no structural damage but would not be functional as a result of damage to vital nonstructural components and contents. Isolation would be expected to mitigate structural and nonstructural damage and protect the facility against loss of function.

The requirements of Chapter 13 provide isolator design displacements, structure-design-shear forces, and other specific requirements for seismically isolated structures. All other design requirements including loads (other than seismic), load combinations, allowable forces and stresses, and horizontal-shear distribution are covered by the applicable sections of the *Provisions* for conventional fixed-base structures.

**TABLE C13.1 Protection Provided by NEHRP Recommended Provisions for Minor, Moderate and Major Levels of Earthquake Ground Motion**

Risk Category	Earthquake Ground Motion Level		
	Minor	Moderate	Major
Life safety <sup>a</sup>	F/I	F/I	F/I
Structural damage <sup>b</sup>	F/I	F/I	I
Nonstructural damage <sup>c</sup> (contents damage)	F/I	I	I

<sup>a</sup> Loss of life or serious injury is not expected for fixed-base (F) or isolated (I) buildings.

<sup>b</sup> Significant structural damage is not expected for fixed-base (F) or isolated (I) buildings.

<sup>c</sup> Significant nonstructural (contents) damage is not expected for fixed-base (F) or isolated (I) buildings.

**13.2 CRITERIA SELECTION:** This section delineates the requirements for the use of the equivalent-lateral-force and dynamic methods of analysis and the conditions for developing a site-specific response spectrum. The limitations on the simplified lateral-force design procedure are quite severe at this time. Limitations cover the site location with respect to active faults; soil conditions of the site, the height, regularity and stiffness characteristics of the building; and the characteristics of the isolation system. In fact, the current limitations will necessitate a dynamic analysis for most isolated structures. Additionally, time-history analysis is required to determine

the design displacement of the isolation system (and the structure above) for the following isolated structures:

1. Isolated structures with a "nonlinear" isolation system including, but not limited to, isolation systems utilizing friction or sliding surfaces, isolation systems with effective damping values greater than about 30 percent of critical, isolation systems not capable of producing a significant restoring force, and isolation systems that restrain or limit extreme earthquake displacement;
2. Isolated structures with a "nonlinear" structure (above the isolation system) including, but not limited to, structures designed for forces that are less than those specified by the *Provisions* for "essentially-elastic" design; and
3. Isolated structures located on Class E or F sites (i.e., very soft soil).

The restrictions placed on the use of equivalent-lateral-force design procedures effectively require dynamic analysis for virtually all isolated structures. However, lower-bound limits on isolation system design displacements and structural-design forces are specified by the *Provisions* in Sec. 13.4 as a percentage of the values prescribed by the equivalent-lateral-force design formulas, even when dynamic analysis is used as the basis for design. These lower-bound limits on key design parameters ensure consistency in the design of isolated structures and serve as a "safety net" against gross under-design. Table C13.2 provides a summary of the lower-bound limits on dynamic analysis specified by the *Provisions*.

**TABLE C13.2 Lower-Bound Limits on Dynamic Analysis Specified as a Percentage of Static-Analysis Design Requirements**

Design Parameter	Static Analysis	Dynamic Analysis	
		Response Spectrum	Time History
Design Displacement - $D_D$	$D_D = (g/4\pi^2)(S_{DI}T_D/B_D)$	–	–
Total Design Displacement - $D_T$	$D_T \geq 1.1D$	$\geq 0.9D_T$	$\geq 0.9D_T$
Maximum Displacement - $D_M$	$D_M = (g/4\pi^2)(S_{MI}T_M/B_M)$	–	–
Total Maximum Displacement - $D_{TM}$	$D_{TM} \geq 1.1D_M$	$\geq 0.8D_{TM}$	$\geq 0.8D_{TM}$
Design Shear - $V_b$ (at or below the <i>Isolation System</i> )	$V_b = k_{Dmax}D_D$	$\geq 0.9V_b$	$\geq 0.9V_b$
Design Shear - $V_s$ ("Regular" Superstructure)	$V_s = k_{Dmax}D_D/R_I$	$\geq 0.8V_s$	$\geq 0.6V_s$
Design Shear - $V_s$ ("Irregular" Superstructure)	$V_s = k_{Dmax}D_D R_I$	$\geq 1.0V_s$	$\geq 0.8V_s$
Drift (calculated using $R_I$ for $C_d$ )	$0.015h_{sx}$	$0.015h_{sx}$	$0.020h_{sx}$

Site-specific design spectra must be developed for both the design earthquake and the maximum considered earthquake if the site is within 10 km of an active fault or if the Site Class is E or F

Lower limits are placed on these site-specific spectra and they must not be less than 80 percent of those given in Sec. 13.4.4.

**13.3 EQUIVALENT-LATERAL-FORCE DESIGN PROCEDURE:** The lateral displacement given by Equation 13.3.3.1 approximates peak design earthquake displacement of a single-degree-of-freedom, linear-elastic system of period,  $T_D$ , and equivalent viscous damping,  $b_D$ , and the lateral displacement given by Equation 13.3.3.3 approximates peak maximum considered earthquake displacement of a single-degree-of-freedom, linear-elastic system of period,  $T_M$ , and equivalent viscous damping,  $b_{DM}$ .

**13.3.3 Minimum-Lateral Displacements:** Equation 13.3.3.1 is an estimate of peak displacement in the isolation system for the design earthquake. In this equation, the spectral acceleration term,  $S_{DI}$ , is the same as that required for design of a conventional fixed-base structure of period,  $T_D$ . A damping term,  $B_D$ , is used to decrease (or increase) the computed displacement when the equivalent damping coefficient of the isolation system is greater (or smaller) than 5 percent of critical damping. Values of coefficient,  $B_D$  (or  $B_M$  for the maximum considered earthquake), are given in Table 13.3.3.1. for different values of isolation system damping,  $b_D$  (or  $b_M$ ).

A comparison of values obtained from Equation 13.3.3.1 and those obtained from nonlinear time-history analyses are given in references by Kircher et al. (1988), Lashkari and Kircher (1993) and Constantinou et al. (1993).

Consideration should be given to possible differences in the properties of the isolation system used for design and the properties of isolation system actually installed in the building. Similarly, consideration should be given to possible changes in isolation system properties due to different design conditions or load combinations. If the true deformational characteristics of the isolation system are not stable or vary with the nature of the load (i.e., rate, amplitude or time dependent), the design displacements should be based on deformational characteristics of the isolation system that give the largest possible deflection ( $k_{Dmin}$ ) and the design forces should be based on deformational characteristics of the isolation system that give the largest possible force ( $k_{Dmax}$ ). If the true deformational characteristics of the isolation system are not stable or vary with the nature of the load (i.e., rate, amplitude or time dependent), the damping level used to determine design displacements and forces should be based on deformational characteristics of the isolation system that represent the minimum amount of energy dissipated during cyclic response at the design level.

The configuration of the isolation system for a seismically isolated building or structure should be selected in such a way as to minimize any eccentricity between the center of mass of the superstructure and the center of rigidity of the isolation system. In this way, the effect of torsion on the displacement of isolation elements will be reduced. As for conventional structures, allowance for accidental eccentricity in both horizontal directions must be considered. Figure C13.3.3 defines the terminology used in the *Provisions*. Equation 13.3.3.5-1 (or Equation 13.3.3.5-2 for the maximum considered earthquake) provides a simplified formulae for estimating the response due to torsion in lieu of a more refined analysis. The additional component of displacement due to torsion increases the design displacement at the corner of the structure by about 15 percent (for a perfectly square building in plan) to about 30 percent (for a very long, rectangular building) if the eccentricity is 5 percent of the maximum plan dimension. Such additional displacement, due to torsion, is appropriate for buildings with an isolation system whose stiffness is uniformly

distributed in plan. Isolation systems that have stiffness concentrated toward the perimeter of the building or certain sliding systems that minimize the effects of mass eccentricity will have reduced displacements due to torsion. The *Provisions* permits values of  $D_T$  as small as  $1.1D_D$ , with proper justification.

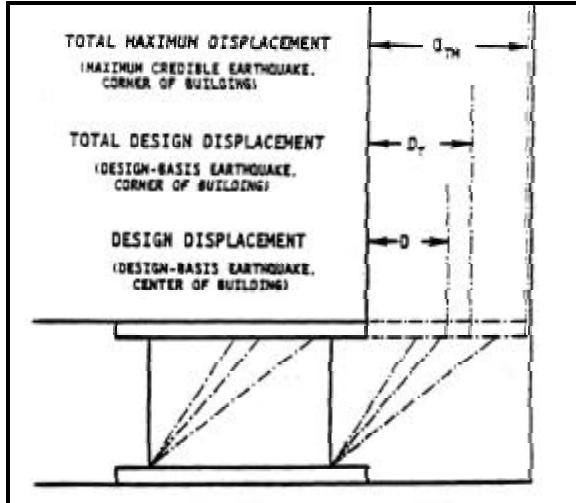

FIGURE C13.3.3 Displacement terminology.

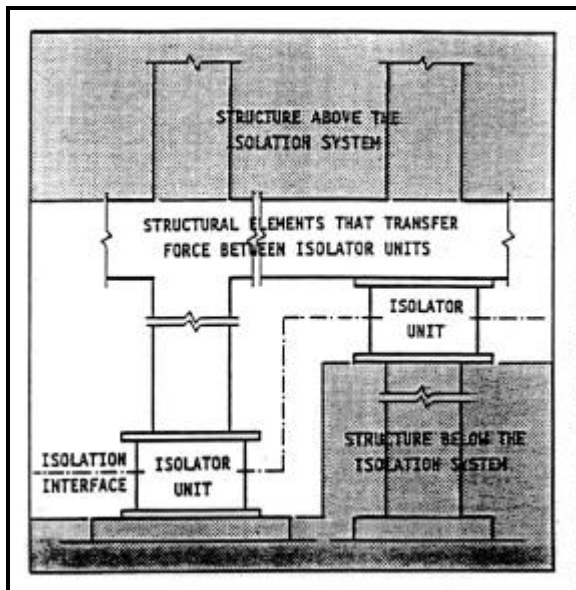

FIGURE C13.3.4 Isolation system terminology.

**13.3.4 Minimum-Lateral Forces:** Figure C13.3.4 defines the terminology below and above the *isolation system*. Equation 13.3.4.1 gives peak seismic shear on all structural components at or below the seismic interface without reduction for ductile response. Equation 13.3.4.2 specifies the peak seismic shear for design of structural systems above the seismic interface. For *structures* that have appreciable inelastic-deformation capability, this equation includes an effective reduction factor of up to 2 for response beyond the strength-design level.

The basis for the reduction factor is that the design of the structural system is based on strength-design procedures. A factor of at least 2 is assumed to exist between the design-force level and the true-yield level of the structural system. An investigation of 10 specific buildings indicated that this factor varied between 2 and 5 (Applied Technology Council, 1982). Thus, a reduction factor of 2 is appropriate to ensure that the structural system remains essentially elastic for the design earthquake.

In Sec. 13.3.4.3, the limitations given on  $V_s$  ensure that there is at least a factor of 1.5 between the nominal yield level of the superstructure and (1) the yield level of the isolation system, (2) the ultimate capacity of a sacrificial-wind-restraint system which is intended to fail and release the superstructure during significant lateral load, or (3) the break-away friction level of a sliding system.

These limitations are essential to ensure that the superstructure will not yield prematurely before

the isolation system has been activated and significantly displaced.

The design shear force,  $V_s$ , specified by the requirements of this section ensures that the structural system of an isolated building will be subjected to significantly less inelastic demands than a conventionally designed structure. Further reduction in  $V_s$ , such that the inelastic demand on a

seismically isolated structure would be the same as the inelastic demand on a conventionally designed structure, was not considered during development of these requirements but may be considered in the future.

If the level of performance of the isolated *structure* is desired to be greater than that implicit in these requirements, then the denominator of Equation 13.3.4.2 may be reduced. Decreasing the denominator of Eq. 13.3.4.2 will lessen or eliminate inelastic response of the superstructure for the design-basis event.

**13.3.5 Vertical Distribution of Force:** Equation 13.3.5 describes the vertical distribution of lateral force based on an assumed triangular distribution of seismic acceleration over the height of the structure above the isolation interface. References by Button (1993) and Constantinou et al. (1993) provide a good summary of recent work which demonstrates that this vertical distribution of force will always provide a conservative estimate of the distributions obtained from more-detailed-nonlinear analysis studies.

**13.3.6 Drift Limits:** The maximum interstory drift permitted for design of isolated structures varies depending on the method of analysis used, as summarized in Table C13.3.6. For comparison, the drift limits prescribed by the *Provisions* for fixed-base structures also are summarized in Table C13.3.6.

**TABLE C13.3.6 Comparison of Drift Limits for Fixed-Base and Isolated Structures**

Structure	Seismic Use Group	Fixed-Base	Isolated
Buildings (other than masonry) four stories or less in height with component drift design	I	$0.025h_{sx}/(C_d/R)$	$0.015h_{sx}$
	II	$0.020h_{sx}/(C_d/R)$	$0.015h_{sx}$
	III	$0.015h_{sx}/(C_d/R)$	$0.015h_{sx}$
Other (non-masonry) buildings	I	$0.020h_{sx}/(C_d/R)$	$0.015h_{sx}$
	II	$0.015h_{sx}/(C_d/R)$	$0.015h_{sx}$
	III	$0.010h_{sx}/(C_d/R)$	$0.015h_{sx}$

Drift limits in Table C13.3.6 are divided by  $C_d/R$  for fixed-base structures since *displacements* calculated for lateral loads reduced by  $R$ , are factored by  $C_d$  before checking drift. The  $C_d$  term is used throughout the *Provisions* for fixed-base structures to approximate the ratio of actual earthquake response to response calculated for "reduced" forces. Generally,  $C_d$  is  $\frac{1}{2}$  to  $\frac{4}{5}$  the value of  $R$ . For isolated structures, the  $R_i$  factor is used both to reduce lateral loads and to increase displacements (calculated for reduced lateral loads) before checking drift. Equivalency would be obtained if the drift limits for both fixed-base and isolated structures were based on their respective  $R$  factors. It may be noted that the drift limits for isolated structures are generally more conservative than those of conventional fixed-base structures, even when fixed-base structures are designed as Seismic Use Group III buildings.

**13.4 DYNAMIC LATERAL RESPONSE PROCEDURE:** This section specifies the requirements and limits of a dynamic analysis. The design displacement and force limits on a response-spectrum and time-history analysis are given in Table C13.2.

A more-detailed or refined study can be performed in accordance with the analysis procedures described in this section. The intent of this section is to provide analysis procedures which are compatible with the minimum requirements of Sec. 13.3. Reasons for performing a more-refined study include:

1. The importance of the building.
2. The need to analyze possible structure/isolation-system interaction when the fixed-base period of the building is greater than one third of the isolated period.
3. The need to explicitly model the deformational characteristics of the lateral-force-resisting system when the structure above the isolation system is irregular.
4. The desirability of using site-specific ground-motion data, especially for soft soil types (Site Class E or F) or for sites located within 10 kilometers of an active fault.
5. The desirability of explicitly modeling the deformational characteristics of the base-isolation system. This is especially important for systems that have damping characteristics that are amplitude, rather than velocity, dependent, since it is difficult to determine an appropriate value of equivalent viscous damping for these systems.

Additionally, time-history analysis is required to determine the design displacement of the isolation system (and the structure above) for the following isolated structures:

1. Isolated structures with a "nonlinear" isolation system including, but not limited to, isolation systems utilizing friction or sliding surfaces, isolation systems with effective damping values greater than about 30 percent of critical, isolation systems not capable of producing a significant restoring force, and isolation systems that restrain or limit extreme earthquake displacement.
2. Isolated structures with a "nonlinear" structure (above the isolation system) including, but not limited to, structures designed for forces that are less than those specified by the SEAOC/UBC provisions for "essentially-elastic" design.
3. Isolated structures located on Class E or F sites (i.e., very soft soil).

When time-history analysis is used as the basis for design, the design displacement of the isolation system and design forces in elements of the structure above are to be based on the maximum of the results of not less than three separate analyses, each using a different pair of horizontal time histories. Each pair of horizontal time histories is to:

1. Be of a duration consistent with the design earthquake or the maximum considered earthquake ,
2. Incorporate near-field phenomena, as appropriate, and



3. Have response spectra whose square-root-sum-of-the-squares combination of the two horizontal components equals or exceeds 1.3 times the "target" spectrum at each spectral ordinate.

The average value of seven time histories is a standard required by the nuclear industry and is considered appropriate for nonlinear time-history analysis of seismically isolated structures.

**13.5 NONSTRUCTURAL COMPONENTS:** To accommodate the differential movement between the isolated building and the ground, provision for flexible utility connections should be made. In addition, rigid structures crossing the interface, (i.e., stairs, elevator shafts and walls, should have details to accommodate differential motion at the isolator level without sustaining damage sufficient to threaten life safety.

**13.6 DETAILED SYSTEM REQUIREMENTS:** Environmental conditions that may adversely effect isolation system performance should be thoroughly investigated. Significant research has been conducted on the effects of temperature, aging, etc., on isolation systems since the 1970s in Europe, New Zealand, and the United States.

**13.6.2.2 Wind Forces:** Lateral displacement over the depth of the isolator zone resulting from wind loads should be limited to a value similar to that required for other story heights.

**13.6.2.3 Fire Resistance:** In the event of a fire, the isolation system should be capable of supporting the weight of the building, as required for other vertical-load-supporting elements of the structure, but may have diminished functionality for lateral (earthquake) load.

**13.6.2.4 Lateral-restoring Force:** The isolation system should be configured with a lateral-restoring force sufficient to avoid significant residual displacement as a result of an earthquake, such that the isolated structure will not have a stability problem and be in a condition to survive aftershocks and future earthquakes.

**13.6.2.5 Displacement Restraint:** The use of a displacement restraint is not encouraged by the *Provisions*. Should a displacement restraint system be implemented, explicit analysis of the isolated structure for maximum considered earthquake is required to account for the effects of engaging the displacement restraint.

**13.6.2.6 Vertical-load Stability:** The vertical loads to be used in checking the stability of any given isolator should be calculated using bounding values of dead load and live load and the peak earthquake demand of the maximum considered earthquake. Since earthquake loads are reversible in nature, peak earthquake load should be combined with bounding values of dead and live load in a manner which produces both the maximum downward force and the maximum upward force on any isolator. Stability of each isolator should be verified for these two extreme values of vertical load at peak maximum considered earthquake displacement of the isolation system.

**13.6.2.7 Overturning:** The intent of this requirement is to prevent global, structural overturning and overstress of elements due to local uplift. Uplift in a braced frame or shear wall is acceptable, provided the isolation system does not disengage from its horizontal-resisting connection detail. The connection details used in some isolation systems are such that tension is not permitted on the system. If the tension capacity of an isolation system is to be utilized on resisting uplift forces,

then component tests should be performed to demonstrate the adequacy of the system on resisting-tension forces at the design displacement.

**13.6.2.8 Inspection and Replacement:** Although most isolation systems will not need to be replaced after an earthquake, it is good practice to provide for inspection and replacement. After an earthquake, the building should be inspected and any damaged elements should be replaced or repaired. It is advised that periodic inspections be made of the isolation system.

**13.6.2.9 Quality Control:** A test and inspection program is necessary for both fabrication and installation of the isolation system. Because base isolation is a developing technology, it may be difficult to reference standards for testing and inspection. Reference can be made to standards for some materials such as elastomeric bearings (ASTM D4014). Similar standards are required for other isolation systems. Special inspection procedures and load testing to verify manufacturing quality should be developed for each project. The requirements will vary with the type of isolation system used.

**13.6.3.2 Building Separations:** A minimum separation between the isolated structure and a rigid obstruction is required to allow free movement in all lateral directions of the superstructure during an earthquake. Provision should be made for lateral motion greater than the design displacement, since the exact upper limit of displacement cannot be precisely determined.

**13.8 DESIGN AND CONSTRUCTION REVIEW:** Design review of the design and analysis of the isolation system and design review of the isolator testing program is mandated by the *Provisions* for two key reasons:

1. The consequences of isolator failure could be catastrophic.
2. Isolator design and fabrication technology is evolving rapidly and may be based on technologies unfamiliar to many design professionals.

These *Provisions* requires review to be performed by a team of registered design professionals that are independent of the design team and other project contractors. The review team should include individuals with special expertise in one or more aspects of the design, analysis and implementation of seismic isolation systems.

The review team should be formed prior to the development of design criteria (including site-specific ground shaking criteria) and isolation system design options. Further, the review team should have full access to all pertinent information and the cooperation of the design team and regulatory agencies involved with the project.

**13.9 REQUIRED TESTS OF THE ISOLATION SYSTEM:** The design displacements and forces developed from the *Provisions* are predicated on the basis that the deformational characteristics of the base isolation system have been previously defined by a comprehensive set of tests. If a comprehensive amount of test data are not available on a system, then major design alterations in the building may be necessary after the tests are complete. This would result from variations in the isolation-system properties assumed for design and those obtained by test. Therefore, it is advisable that prototype systems be tested during the early phases of design, if sufficient test data is not available on an isolation system.

Typical force-deflection or hysteresis loops are shown in Figure C13.9; also included are the definitions of values used in Sec. 13.9.3.

The required sequence of tests will experimentally verify:

1. The assumed stiffness and capacity of the wind-restraining mechanism;
2. The variation in the isolator's deformational characteristics with amplitude and with vertical load, if it is a vertical load-carrying member;
3. The variation in the isolator's deformational characteristics for a realistic number of cycles of loading at the design displacement; and
4. The ability of the system to carry its maximum and minimum vertical loads at the maximum displacement.

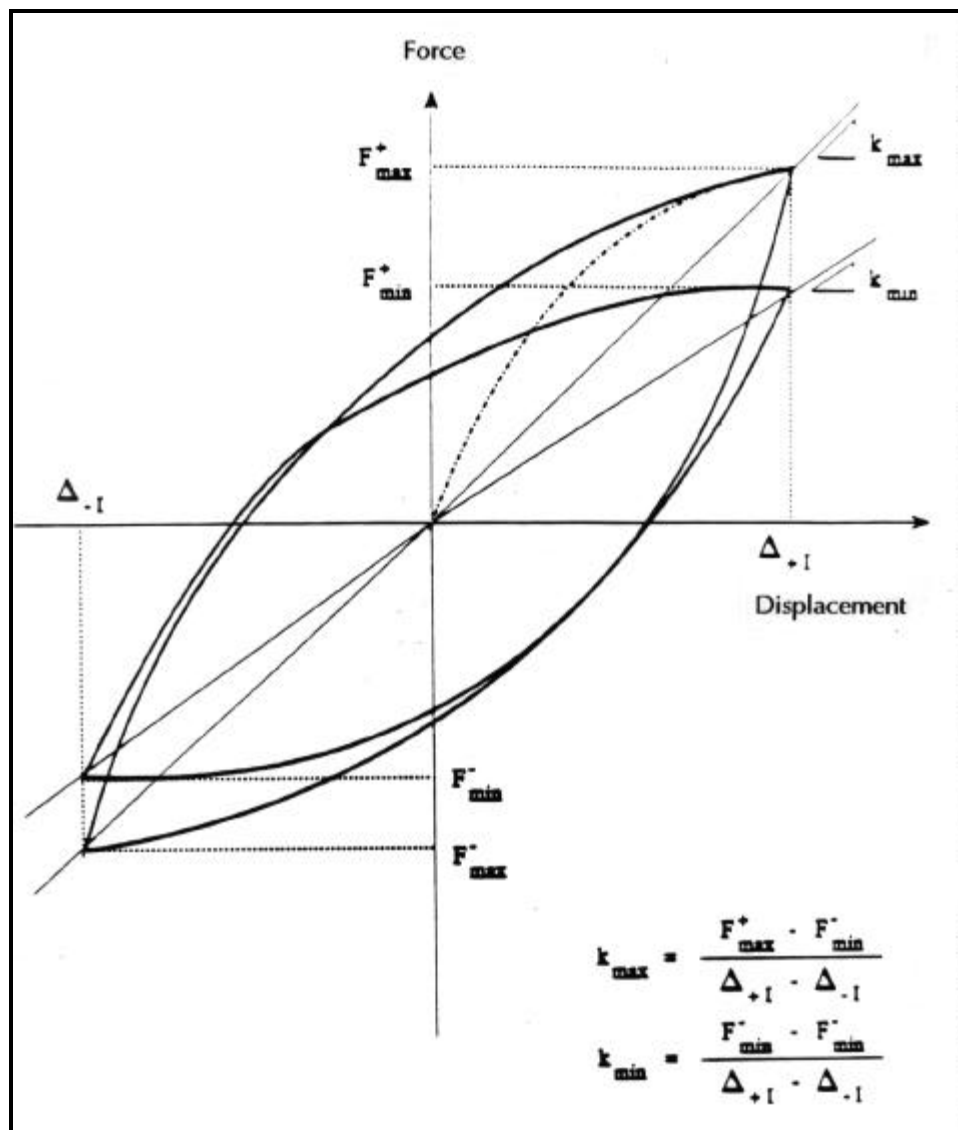

FIGURE 13.9 The effect of stiffness on an isolation bearing.

Force-deflection tests are not required if similarly-sized components have been previously tested using the specified sequence of tests.

Variations in effective stiffness greater than  $\pm 15$  percent over 3 cycles of loading at a given amplitude, or  $\pm 20$  percent over the larger number of cycles at the design displacement, would be cause for rejection. The variations in the vertical loads required for tests of isolators which carry vertical, as well as lateral, load are necessary to determine possible variations in the system properties with variations in overturning force. The appropriate dead loads and overturning forces for the tests are defined as the average loads on a given type and size of isolator for determining design properties and are the absolute maximum and minimum loads for the stability tests.

**13.9.5.1 Effective Stiffness:** The effective stiffness is determined from the hysteresis loops shown in Figure C13.9). Stiffness may vary considerably as the test amplitude increases but should be reasonably stable ( $\pm 15$  percent) for more than 3 cycles at a given amplitude.

The intent of these requirements is to ensure that the deformational properties used in design result in the maximum design forces and displacements. For determining design displacement, this means using the lowest damping and effective-stiffness values. For determining design forces, this means using the lowest damping value and the greatest stiffness value.

**13.9.5.2 Effective Damping:** The determination of equivalent viscous damping is reasonably reliable for systems whose damping characteristics are velocity dependent. For systems that have amplitude-dependent, energy-dissipating mechanisms, significant problems arise in determining an equivalent viscous-damping value. Since it is difficult to relate velocity and amplitude-dependent phenomena, it is recommended that when the equivalent-viscous damping assumed for the design of amplitude-dependent, energy-dissipating mechanisms (e.g., pure-sliding systems) is greater than 30 percent, then the design-basis force and displacement should be determined by the time-history-analysis method, as specified in Sec. C13.2.

## REFERENCES

- Applied Technology Council. 1982. *An Investigation of the Correlation Between Earthquake Ground Motion and Building Performance*, ATC Report 10. Redwood City, California: ATC
- Applied Technology Council. 1986. *Proceedings of a Seminar and Workshop on Base Isolation and Passive Energy Dissipation*, ATC Report 17. Redwood City, California: ATC.
- Applied Technology Council. 1993. *Proceedings of Seminar on Seismic Isolation, Passive Energy Dissipation, and Active Control*, ATC 17-1. Redwood City, California: ATC.
- American Society of Civil Engineers. 1989, 1991, 1993, and 1995. *Seismic Engineering: Research and Practice*. New York City: ASCE.
- Constantinou, M. C., C. W. Winters, and D. Theodossiou. 1993. "Evaluation of SEAOC and UBC analysis procedures, Part 2: Flexible superstructure," in *Proceedings of a Seminar on Seismic Isolation, Passive Energy Dissipation and Active Control*, ATC Report 17-1. Redwood City, California: ATC.
- Earthquake Engineering Research Institute. 1990. "Seismic isolation: from idea to reality," *Earthquake Spectra Journal* 6:2.

Kircher, C. A., B. Lashkari, R. L. Mayes, and T. E. Kelly. 1988. "Evaluation of nonlinear response in seismically isolated buildings," in *Proceedings of a Symposium on Seismic, Shock and Vibration Isolation*, ASMA PVP Conference.

Lashkari, B., and C. A. Kircher. 1993. "Evaluation of SEAOC & UBC analysis procedures, part 1: stiff superstructure," in *Proceedings of a Seminar on Seismic Isolation, Passive Energy Dissipation and Active Control*, ATC Report 17-1. Redwood City, California: ATC.

Lashkari, B., and C. A. Kircher. 1990. *Proceedings of Fourth U.S. National Conference on Earthquake Engineering*. Berkeley, California: Earthquake Engineering Research Institute.

Skinner, R. I., W. H. Robinson, and G. H. McVerry. 1993. *An Introduction to Seismic Isolation*. Sussex, England: Wiley and Sons.

## Chapter 14 Commentary

### NONBUILDING STRUCTURE DESIGN REQUIREMENTS

#### 14.1 GENERAL:

**14.1.1 Scope:** Requirements concerning nonbuilding structures were originally added to the 1994 *Provisions* by the 1991-94 *Provisions* Update Committee (PUC) at the request of the BSSC Board of Direction to provide building officials with needed guidance. In recognition of the complexity, nuances and importance of nonbuilding structures, the BSSC Board established 1994-97 PUC Technical Subcommittee 13 (TS13), Nonbuilding Structures, in 1995. The duties of TS13 were to review the 1994 *Provisions* and *Commentary* and recommend changes for the 1997 Edition. The subcommittee was composed of individuals possessing considerable expertise concerning various specialized nonbuilding structures and representing a wide variety of industries concerned with nonbuilding structures.

Building codes traditionally have been perceived as minimum standards of care for the design of nonbuilding structures and building code compliance of these structures is required by building officials in many jurisdictions. However, requirements in the industry standards are often at odds with building code requirements. In some cases, the industry standards need to be altered while in other cases the building codes need to be modified. Registered design professionals are not always aware of the numerous accepted standards within an industry or if the accepted standards are adequate. It is hoped that the 1997 *Provisions* requirements for nonbuilding *structures* appropriately bridge the gap between building code and existing industry standards.

One of TS13's goals was to review and list appropriate industry standards to serve as a resource. These standards had to be included in the appendix. The subcommittee also has attempted to provide an appropriate link so that the accepted industry standards can be used with the seismic ground motions established in the *Provisions*. It should be noted that some nonbuilding structures are very similar to a building and can be designed employing sections of the *Provisions* directly whereas other nonbuilding structures require special analysis unique to the particular type of nonbuilding structure.

The ultimate goal of TS13 was to provide guidance to develop requirements consistent with the intent of the *Provisions* while allowing the use of accepted industry standards. Some of the referenced standards are consensus documents while others are not.

One good example of the dilemma posed by the conflicts between the *Provisions* and accepted design practice for nonbuilding structures are steel multilegged water towers. Historically, such towers have performed well when properly designed per American Water Works Association (AWWA) standards, but these standards differ from the *Provisions* because tension-only rods are required and the connection forces are not amplified. However, industry practice requires upset rods that are preloaded at the time of installation, and the towers tend to perform well in earthquake areas.

In an effort to provide the appropriate interface between the *Provision's* requirements for building structures, nonstructural components, and nonbuilding structures; TS13 recommended that nonbuilding structure requirements be placed in a separate chapter. The PUC agreed with this change. The 1997 *Provisions* Chapter 14 now provides registered design professionals responsible for designing nonbuilding structures with a single point of reference.

Note that building structures, vehicular and railroad bridges, nuclear power plants, and dams are excluded from the scope of the nonbuilding structure requirements. The excluded structures are covered either by other sections of the *Provisions* or by other well established design criteria (vehicular and railroad bridges, nuclear power plants, and dams).

**14.1.2:** This section has been developed to provide an appropriate link between the requirements for nonbuilding structures and those for inclusion in the rest of the *Provisions*, especially the requirements for architectural, mechanical, and electrical components.

**14.1.5:** The rational methods for period calculation contained in the *Provisions* were developed for building structures. If the nonbuilding structure has dynamic characteristics similar to a building, the difference in period is insignificant. If the nonbuilding structure is not similar to a building structure, other techniques for period calculation will be required. Some of the references in the Appendix of this chapter for specific types of nonbuilding structures may contain more accurate methods for period determination.

## **14.2 STRUCTURAL DESIGN REQUIREMENTS:**

**14.2.1 Design Basis:** The subcommittee wanted to employ the new seismic ground motion maps and the new methodology for establishing seismic design and detailing contained in the 1997 *Provisions*.

**14.2.1.1 Seismic Factors:** Table 14.2.1.1 has been formulated to be consistent with the *Provisions*. The values listed here are generally lower than the values for buildings. Lower values are assigned in recognition of the structural performance of nonbuilding structures as opposed to building structures. Nonbuilding structures tend to be lightly damped, less redundant, and more given to performance failure when the structure exhibits nonlinear performance.

**14.2.1.2 Importance Factors and Seismic Importance Group Classifications:** The Importance Factors and Seismic Use Group classifications assigned nonbuilding structures vary from those assigned building structures. Buildings are designed to protect occupants inside the structure whereas nonbuilding structures are not normally “occupied” in the same sense as buildings, but need to be designed in a special manner because they pose a different sort of risk in regard to public safety (i.e., they may contain very hazardous compounds or be essential components in critical lifeline systems). For example, tanks and vessels may contain materials that are essential for lifeline functions following a seismic event (i.e., fire fighting, potable water), potentially harmful or hazardous to the environment or general health of the public, biologically lethal or toxic, or explosive or flammable (threat of consequential or secondary damage).

If not covered by the authority having jurisdiction, Table 14.2.1.2.1 may be used to select the importance factor (*I*). The value selected should be the highest value that applies to the structure or siting situation. The importance factor is not intended for use in making economic evaluations regarding the level of damage, probabilities of occurrence, or cost to repair the structure. These

economic decisions should be made by the owner and other interested parties (insurers, financiers, etc). Following are examples demonstrating how this table may be applied:

**Example 1:**

A water storage tank used to provide pressurized potable water for a process within a chemical plant where the tank is located away from personnel working within the facility.

**TABLE 14.2.1.2 Importance Factor (*I*) and Seismic Use Group Classification for Nonbuilding Structures**

<b>Importance Factor</b>	<b><i>I</i> = 1.0</b>	<b><i>I</i> = 1.25</b>	<b><i>I</i> = 1.5</b>
<b>Seismic Use Group</b>	<b>I</b>	<b>II</b>	<b>III</b>
Hazard	H - I	H - II	H - III
Function	F - I	F - II	F - III

Address each of the issues implied in the matrix:

Seismic Use Group — Neither the structure nor the contents are critical, therefore use Seismic Use Group I.

Hazard — The contents are not hazardous, therefore use H - I.

Function — The water storage tank is not ancillary to and is not a Seismic Use Group III structure, therefore use F - I.

This tank has an importance factor of 1.0.

**Example 2:**

A steel storage rack is located in a retail store in which the customers have direct access to the aisles. Merchandise is stored on the upper racks. The rack is supported from a slab on grade.

**TABLE 14.2.1.2 Importance Factor (*I*) and Seismic Use Group Classification for Nonbuilding Structures**

<b>Importance Factor</b>	<b><i>I</i> = 1.0</b>	<b><i>I</i> = 1.25</b>	<b><i>I</i> = 1.5</b>
<b>Seismic Use Group</b>	<b>I</b>	<b>II</b>	<b>III</b>
Hazard	H - I	H - II	H - III
Function	F - I	F - II	F - III

Address each of the issues in the matrix.:

Seismic Use Group — Neither the structure nor the contents are critical, therefore use Seismic Use Group I.

Hazard — The contents are not hazardous, therefore use H - I.



Function — The storage rack is not ancillary to and is not a Seismic Use Group III structure, therefore use F - I.

Within the steel storage rack section in the *Provisions* there exists a link back to Sec. 6.9 and to Sec. 6.1.5 requiring an  $I_p$  or  $I$  of 1.5.

Use an importance factor of 1.5 for this structure.

**Example 3:**

A water tank is located within an office building complex to supply the fire sprinkler system.

**TABLE 14.2.1.2 Importance Factor ( $I$ ) and Seismic Use Group Classification for Nonbuilding Structures**

Importance Factor	$I = 1.0$	$I = 1.25$	$I = 1.5$
Seismic Use Group	<b>I</b>	<b>II</b>	<b>III</b>
Hazard	H - I	H - II	H - III
Function	F - I	F - II	F - III

Address each of the issues in the matrix.:

Seismic Use Group — The office building is Seismic Use Group I.

Hazard — The contents are not hazardous, therefore use H - I.

Function — The water tank is required to provide water for fire fighting, therefore use F - III.

Use an importance factor of 1.5 for this structure.

**Example 4:**

A gasoline storage tank is to be constructed within a refinery tank farm. Impoundment diking is provided to control liquid spills.

**Table 14.2.1.2  
Importance Factor ( $I$ ) and Seismic Use Group Classification  
for Nonbuilding Structures**

Importance Factor	$I = 1.0$	$I = 1.25$	$I = 1.5$
Seismic Use Group	<b>I</b>	<b>II</b>	<b>III</b>
Hazard	H - I	H - II	H - III
Function	F - I	F - II	F - III

Address each of the issues in the matrix.:

Seismic Use Group — The structure is classified as Seismic Use Group I.

Hazard — The contents constitute a high explosion and fire hazard, therefore use H - III.

Function — The tank is not required to provide water critical facilities, therefore use F - I.

Use an importance factor of 1.5 for this structure.

**14.2.2: Rigid Nonbuilding Structures:** The equation included in the 1994 *Provisions* did not agree with the formulas contained in the 1994 *Uniform Building Code (UBC)*. The Seismic Design Procedure Group recommended using the  $S_{DS}$  factor and eliminating the  $C_a$  factor. The appropriate changes are incorporated in the 1997 *Provisions*.

**14.3 NONBUILDING STRUCTURES SIMILAR TO BUILDINGS:** This general class of nonbuilding structures exhibits behavior similar to that of building structure; however, function and performance are different. The *Provisions* were used as the primary basis for design with industry-driven exceptions, modifications, and additions.

**14.3.3 Steel Storage Racks:** The Rack Manufacturers Institute (RMI) has developed and maintained a specification that is utilized by much of the storage rack industry. The RMI is in the process of obtaining ANSI consensus.

An attempt has been made to incorporate this specification in the 1997 *Provisions* in a manner ensuring that the applicable requirements of the *Provisions* also are met. All storage racks can be designed in accordance with the Rack Manufacturers Institute specification provided that design force requirements are not less than those required by the force requirements for architectural systems and components.

In addition, storage racks located at grade may be designed to the same requirements as building structures provided that all the force and detailing requirements of Chapters 5 and 9 are met.

Based on storage rack performance experienced during the 1994 Northridge earthquake, it is judged to be necessary to account for 67 percent of the rated rack load in determining the seismic weight.

**14.3.4 Electrical Power Generating Facilities:** Electrical power plants closely resemble building structures, and their performance in seismic events has been good. For reasons of mechanical performance, lateral drift of the structure must be limited. The lateral bracing system of choice has been the concentrically braced frame. The height limits on braced frames in particular can be an encumbrance to the design of large power generation facilities. For this reason, the exception to height limits in Sec. 14.2.1 was required.

**14.3.6 Piers and Wharves:** Although previous editions of the *Provisions* did not include a specific section on piers and wharves, the inclusion of these structures was deemed necessary to properly account for the effect of hydrodynamic and liquefaction effects unique to these types of structures.

**14.4 NONBUILDING STRUCTURES NOT SIMILAR TO BUILDINGS:** This general class of nonbuilding structures exhibits behavior markedly different from that of building structures. Most of these types of structures have industry standards that address their unique structural performance and behavior. The new elements of the 1997 *Provisions* regarding ground motion required that a prudent link to the industry standards be developed.

**14.4.1 General:**

**14.4.2 Earth Retaining Structures:**

**14.4.3 Tanks and Vessels:** The majority of this section was moved to the Appendix

**14.4.5 Telecommunication Towers:**

**14.4.5.1 General:** The majority of this section was moved to the Appendix

**14.4.6 Stacks and Chimneys:** The design of stacks and chimneys to resist natural hazards is generally governed by wind design considerations. The exceptions to this general rule involve locations with high seismicity, stacks and chimneys with large elevated masses, and stacks and chimneys with unusual geometries. It is prudent to evaluate the effect of seismic loads in all but those areas with the lowest seismicity. Although not specifically required, it is recommended that the special seismic details required elsewhere in the *Provisions* be evaluated for applicability to stacks and chimneys.

Guyed steel stacks and chimneys are generally light weight. As such the design loads due to natural hazards are generally governed by wind. On occasion, large flares or other elevated masses located near the top may require an in-depth seismic analysis. Although Chapter 6, "Multilevel Guyed Stacks" in *Tubular Steel Structures* by M. S. Troitsky does not specifically address seismic loading, it remains an applicable methodology for resolution of seismic forces that can be determined in these *Provisions*.

**14.4.10 Inverted Pendulums:** These structures are those that support an elevated lumped mass but water tanks are excluded.

## Appendix to Chapter 14

**PREFACE:** The following sections were originally intended to be part of the Nonbuilding Structures Chapter of this Commentary. The *Provisions* Update Committee felt that given the complexity of the issues, the varied nature of the resource documents, and the lack of supporting consensus resource documents, time did not allow a sufficient review of the proposed sections required for inclusion into the main body of the chapter.

The Nonbuilding Structures Technical Subcommittee, however, expressed that what is presented herein represents the current industry accepted design practice within the engineering community that specializes in these types of nonbuilding structures.

The *Commentary* sections are included here so that the design community specializing in these nonbuilding structures can have the opportunity to gain a familiarity with the concepts, update their standards, and send comments on this appendix to the BSSC.

It is hoped that the various consensus design standards will be updated to include the design and construction methodology presented in this Appendix. It is also hoped that industry standards that are currently not consensus documents will endeavor to move their standards through the consensus process facilitating building code inclusion.

**A14.1.8 References and Standards:** TS13 believed it essential to provide a controlled link between the *Provisions* and industry design standards. While the subcommittee wanted to employ the new seismic ground motion maps and the new methodology for establishing seismic design and detailing contained in the 1997 *Provisions*, it did not want to abandon the design methodologies established by the various industries involved with nonbuilding structures.

As previously stated, some of the Chapter 14 references are not consensus documents; however, the cited references do represent the current state of structural design practice in the various industries. The references are divided into three categories: standards, industry standards, and industry references. There is ample precedence to incorporate ANSI or ASCE consensus documents (as contained in the standards section) into an international code, and local code officials often include industry standards in their local jurisdictions. With the lack of any form of consensus standards, some industries use other industry references as a method of establishing a structural design methodology.

**A14.1.9 Industry Design Standards and Recommended Practice:** This section was added to aid the registered design professionals in identifying the industry standards for a particular type of nonbuilding structure. There are no industry standards for some nonbuilding structures and, in those cases, the commonly accepted design approaches contained in reference and text books are cited.

The list of petrochemical facilities includes: structures that have a dynamic response similar to building structures that support equipment such as air coolers, horizontal vessels, heat exchangers, heaters, vertical vessels, and reactors; equipment behaving similar to structures with

integral supports such as stand-alone vertical vessels/heaters, tanks, spheres, boilers, chimneys, and stacks; concrete or steel pipe ways; and cooling towers.

#### **A14.4.3 Tanks and Vessels:**

**A14.4.3.1 General:** The standards for tanks and vessels have specific requirements to safeguard against catastrophic failure of the primary structure based on observed behavior in seismic events since the 1930s. The procedures used to design flat bottom storage tanks and liquid containers is based on the work of Housner (Ref A14-43) and Wozniak and Mitchell (Ref A14-40).

The requirements in Sec 14.4.3 are intended to link the latest procedures for determining design level seismic loads with the allowable stress design procedures based on the *UBC* methods. These requirements, which in many cases identify specific substitutions to be made in the design equations of the national standards, will assist users of the *Provisions* in making consistent interpretations.

**A14.4.3.1.1 Strength and Ductility:** As is the case for building structures, ductility and redundancy in the lateral support systems for tanks and vessels are desirable and necessary for good seismic performance. Tanks and vessels are not highly redundant structural systems and, therefore, ductile materials and well designed connection details are needed to increase the capacity of the vessel to absorb more energy without failure. The critical performance of many tanks and vessels is governed by shell stability requirements rather than by yielding of the structural elements.

**A14.4.3.1.2 Flexibility of Piping Attachments:** The performance of piping connections under seismic deformations is one of the primary weaknesses observed in recent seismic events. Tank leakage and damage occurs when the piping connections cannot accommodate the movements the tank experiences during the a seismic event. Contrary to the design methods used by many piping designers, which impart mechanical loading to the tank shell, piping systems in seismic areas should be designed in such a manner as to impose negligible mechanical loads on the tank connection for the values shown in Table 14.4.3.1.2.

In addition, interconnected equipment, walkways, and bridging between multiple tanks must be designed to resist the loads and displacements imposed by seismic forces. Unless multiple tanks are founded on a single rigid foundation, walkways, piping, bridges and other connecting structures must be designed to allow for the calculated differential movements between connected structures due to seismic loading assuming the tanks and vessels are out of phase.

**A14.4.3.1.3 Anchorage:** Many steel tanks can be designed without anchors by using the annular plate procedures given in the national standards. Those tanks that must be anchored because of overturning potential could be susceptible to shell tearing if not properly designed. Ideally, the proper anchorage design will provide both a shell attachment and embedment detail that will yield the bolt without tearing the shell or pulling the bolt out the foundation. Properly designed anchored tanks retain greater reserve strength to resist seismic overload than unanchored tanks.

### A14.4.3.2 Ground Supported Storage Tanks for Liquids:

**A14.4.3.2.1 General:** The response of ground storage tanks to earthquakes is well documented by Housner, Mitchell and Wozniak, Valets, and others. Unlike building structures, the structural response is strongly influenced by the fluid-structure interaction. Fluid-structure interaction forces are categorized as sloshing (convective mass) and rigid (impulsive mass) forces. The proportion of these forces depends on the geometry (height to diameter ratio) of the tank. Ref A14-1 and A14-4 provide the necessary data to determine the relative masses and moments for each of these contributions.

**A14.4.3.2.1.1 Freeboard:** Performance of ground storage tanks in past earthquakes has indicated that sloshing of the contents can cause leakage and damage to the roof and internal components. While the effect of sloshing often involves only the cost and inconvenience of making repairs, not catastrophic failure, even this limited damage can be prevented or significantly mitigated when the following aspects are considered:

1. Effective masses and hydro-dynamic forces in the container
2. Impulsive and pressure loads.
  - a. Sloshing zone (i.e. the upper shell and edge of roof system).
  - b. Internal supports (roof support columns, tray-supports, etc.).
  - c. Equipment (distribution rings, access tubes, pump wells, risers, etc.).
3. Freeboard (depends on the sloshing wave height).

Tanks and vessels storing biologically or environmentally benign materials do not typically require freeboard to protect the public health and safety. However, providing freeboard in areas of frequent seismic occurrence for vessels normally operated at or near top capacity may lessen damage (and the cost of subsequent repairs) to the roof and upper container.

The estimate given in the *Provision* Sec 14.4.3.2.1.1 is based on a median response spectrum rather than on the one standard deviation response spectra found in Ref. A14-42. It is also based on the seismic design event as defined by the *Provisions*. Estimates for the sloshing height contained in national standards are based on the one standard deviation spectra applied at a working stress level. Users of the *Provisions* may estimate slosh heights different from those recommended in the national standards.

**A14.4.3.2.1.4 Sliding Resistance:** Steel ground-supported tanks full of product have not been found to slide off foundations. Resistance to sliding is obtained from the frictional resistance between the steel bottom and the sand cushion on which bottoms are placed. Because tank bottoms usually are crowned upward toward the tank center and are constructed of overlapping fillet welded individual steel plates (resulting in a rough bottom), it can be considered reasonable conservative to take the ultimate coefficient of friction as 0.70 (U.S. Nuclear Regulatory Commission, 1989, pg A-50) and, therefore, a value of  $\tan 30^\circ$  (0.577) is used. The vertical weight of the tank and contents reduced by the component of vertical acceleration provides the

net vertical load. An orthogonal combination of vertical and horizontal seismic forces following the procedure in Sec.2.2.5.3.2 may be used.

#### **A14.4.3.2.2 Water and Water Treatment Structures:**

**A14.4.3.2.2.1 Welded Steel:** The AWWA design requirements for of ground-supported steel water storage structures is based on an allowable stress method that utilizes an effective mass procedure considering two response modes of the tank and its contents:

1. The high-frequency amplified response to seismic motion of the tank shell, roof, and impulsive mass (portion of liquid content of the tank that moves in unison with the shell) and
2. The low frequency amplified response of the convective mass (portion of the liquid contents in the fundamental sloshing mode).

The two-part AWWA equation incorporates the above modes, appropriate damping, site amplification, allowable stress response modification and zone coefficients. In practice, the typical ground storage tank and impulsive contents will have a natural period,  $T_{es}$  of 0.1 to 0.3 sec. The sloshing period typically will be greater than 1 sec (usually 3 to 5 sec depending on tank geometry). Thus, the substitution in the *Provisions* uses a short- and long-period response as it applies to the appropriate constituent term in the AWWA equations.

#### **A14.4.3.2.3 Petrochemical and Industrial Liquids:**

**A14.4.3.2.3.1 Welded Steel:** See Sec. 14.4.3.2.2.1 for description of the  $S_{as}$  and  $S_{al}$  substitution. The American Petroleum Institute (API) also uses an allowable stress design procedure and the API equation has incorporated an  $R_w$  factor equal to 4.1667 for all API designed ground storage structures. Therefore, one will not find an  $R$  for API 620 or 650 flat bottom storage structures in Table 14.2.1.1.

**A14.4.4 Electrical Transmission, Substation, and Distribution Structures:** The design of electrical transmission, substation wire support, and distribution structures is typically controlled by high wind, ice-wind combinations, and unbalance longitudinal wire loads (Agrawal and Kramer, 1976; ASCE, 1991; IEEE, 1997). Distribution structures typically support equipment with low mass and seismic loads do not control their design. Earthquake performance of these structures has demonstrated that seismic loads can be resisted based on traditional electrical transmission, substation, and distribution wire support structure loading (Steinhardt, 1981). These structures may be used in special situations where seismic loads should be considered in their design. The special situations for transmission and substation wire support structures may include site specific low wind velocity and ice load, and no designed unbalance longitudinal wire load. For distribution structures, the number of supported transformers may result in significant seismic load.

Earthquake-related damage to electrical transmission, substation wire support, and distribution structures typically is caused by large displacements of the foundations due to landslides, ground failure, and liquefaction (FEMA, 1990). These situations have resulted in structural failure or damaged structural members without complete loss of structure function.

The fundamental frequency of these structure types typically ranges from 0.5 to 6 Hz. Single pole type structures have fundamental mode frequencies in the 0.5 to 1.5 Hz range. H-frame struc-

tures have fundamental mode frequencies in the 1 to 3 Hz ranges, with the lower frequencies in the direction normal to the plane of the structure and the higher frequencies in plane. Four legged lattice structures have fundamental mode frequencies in the range of 2 to 6 Hz. Lattice tangent structures typically have lower frequencies with the higher frequencies being representative of angle and dead end structures. These frequency ranges can be used to determine if earthquake loading should be a design consideration. If it is determined that earthquake loads are significant then a more detailed evaluation of the structure vibration frequencies and mode shapes should be performed. This can be accomplished using available commercial finite element computer programs. The default viscous damping value to be used in such an analysis should be 2 percent. A higher damping value can be used if determined using sound engineering data.

A minimum importance factor ( $I$ ) of 1.0 should be used to provide the necessary seismic resistance. An  $I$  of 1.0 is required to minimize the loss of function after an earthquake event even though these systems are normally redundant.

The  $R$  values shown in Table 14.2.1.1 reflect the inelastic reserve strength of the structural systems during an earthquake event. The values presented for these types of structures were determined based on a review of published values established for building structures and nonbuilding structures. An analysis of lattice (truss) type transmission towers dictated  $R$  values in the range of 3 to 8 (Lyver, Mueller and Kempner, 1996). The value of 3 for truss systems shown in Table 14.2.1.1 represents the lower bound value of  $R$ . In general, the remaining  $R$  values shown reflect the earthquake performance of these structural systems and engineering judgment. Other values may be appropriate if determined using sound engineering data.

The  $C_d$  and  $\Omega$  values shown in Table 14.2.1.1 for these types of *structures* are presented for information only and to be consistent with parameters presented for other facilities covered by the *Provisions*. The  $C_d$  value is a factor used to estimate the peak inelastic deflection ( $d_{inel}$ ) during a seismic event when the elastic displacements ( $d_{el}$ ) from a static analysis using seismic loads are known ( $d_{inel} = d_{el}C_d$ ). The  $\Omega$  values represent a component force factor to be used to provide increased reliability in strength for a critical component (component force times  $\Omega$ ). The magnitude of this factor is currently specified (when used) by the industry design standards and recommended practices specified in Sec. 14.1.8.

Traditionally, wire supported mass and dynamic effects have not been included in the evaluation of structural response (Long, 1973). Some studies have suggested that for long spans the seismic contribution of the wires should not be neglected (Li et al., 1991; Li et al. 1994). Reasons for neglecting the supported wires are the order of magnitude difference between the wire system natural frequency and that of the supporting structures and the method of connection between these two systems. The spatial distribution of the structural system (varying wire spans, tower location and geometry, and seismic ground motion) also helps mitigate the effects of dynamic coupling. The satisfactory performance of these structures during earthquakes does not justify the additional loading as a result of the wire dynamics. Engineering judgment should be used to determine the inclusion or the significance of the wire mass.

**A14.4.5 Telecommunication Towers:** The design of telecommunication towers is typically controlled by extreme wind, ice and wind combinations, and restrictive deflection (serviceability) limits (EIA TIA 222; Canadian Standards Association, 1994). Earthquake performance of these



structures has demonstrated that seismic loads can be resisted based on traditional telecommunication loading (Lum et al., 1983). As a minimum, this requirement should be to determine the significance of seismic loads in the design of the tower. Seismic lateral loads in combination with long-term ice loads should be considered. Recommendations for combined load effects can be found in ANSI/ASCE 7.

A general industry survey indicated that the seismic performance of these structures to earthquake loading has been acceptable. Reported earthquake damage has been limited to failure of building mounted towers and shifting of mounted antennas resulting in misalignment of the signal path (FEMA, 1990; Lum et al., 1983; NCEER, 1995; Steinhardt, 1981).

The fundamental frequency of these structural types typically ranges from 0.5 to 10 Hz. If it is determined that earthquake loads are significant then a more detailed evaluation of the structure's vibration frequencies and mode shapes should be performed. This can be accomplished using available commercial finite element computer programs. The default viscous damping value to be used with such an analysis should be 2 percent. A higher damping value can be used if determined using sound engineering data.

Recent studies (Galvez and McClure, 1995) have suggested that a linear lateral force distribution ( $k = 1$ ) is not an accurate representation for self-supporting telecommunication towers. The lateral force distribution being studied accounts for the mass participation of the lowest three flexural modes of vibration of the tower. Until further studies have been completed and a final recommendation is available it is recommended that a linear distribution be used with the *Provisions* when a refined lateral force distribution is required.

The R values shown in Table 14.2.1.1 reflect the inelastic reserve strength of the structural systems during an earthquake event. The values presented for these types of structures were determined based on a review of published values established for building structures and nonbuilding structures. Other values may be appropriate if determined using sound engineering data.

The  $C_d$  and  $\Omega$  values shown in Table 14.2.1.1 for these types of structures are presented for information only and to be consistent with parameters presented for other facilities covered by the *Provisions*. The  $C_d$  value is a factor used to estimate the peak inelastic deflection ( $d_{inel}$ ) during a seismic event when the elastic displacements ( $d_{el}$ ) from a static analysis using seismic loads are known ( $d_{inel} = d_{el}C_d$ ). The  $\Omega$  values represent a component force factor to be used to provide increased reliability in strength for a critical component (component force times  $\Omega$ ). The magnitude of this factor is currently specified (when used) by the industry design standards and recommended practices specified in Sec. 14.1.8.

Guyed towers taller than 66 m should be evaluated using modal analysis procedures. Modeling of a guyed tower must allow for geometric nonlinearities and potential interactions between the mast and the guy wires (Amiri and McClure, 1996). The significant earthquake effect will be due to the dynamic interaction between the mast and the guy wires. The analysis of guyed towers can be accomplished using available commercial finite element computer programs.

Reference A14-12C has an informative appendix that provides guidance on when earthquake design of guyed and self-supporting telecommunication towers may be appropriate. The following information is obtained from this document.

1. Steel lattice and guyed towers are less sensitive to earthquake loads than most other structure types.
2. Self-supporting lattice towers up to 100 m high and having insignificant mass concentrations less than 25 percent of their total mass need not be designed for earthquakes.
3. Self-supporting lattice towers of insignificant mass and over 100 m high or lesser height with significant mass concentrations may experience base shears and base overturning moments approaching those caused by ultimate wind loads.
4. Self-supporting lattice towers and guyed steel masts that are in earthquake design zones should be designed considering the vertical component of ground motion. For very tall guyed towers, some vertical ground motion differentials between the mast base and guy anchorage points may be an important design consideration depending on local seismicity.



## Commentary Appendix A

# DEVELOPMENT OF MAXIMUM CONSIDERED EARTHQUAKE GROUND MOTION MAPS 1 THROUGH 24

### BACKGROUND

The Building Seismic Safety Council (BSSC) has been working for several years to replace the 1994 *Provisions* Maps 1 through 4, which were developed about 20 years ago. The 1994 *Provisions* Maps 1 through 4 provided the  $A_a$  (effective peak acceleration coefficient) and  $A_v$  (effective peak velocity-related acceleration coefficient) values to use for design. The BSSC has always recognized that the maps and coefficients would change with time as the profession gained more knowledge about earthquakes and their resulting ground motions and as society gained greater insight into the process of establishing acceptable risk.

In the past 20 years, significant additional earthquake data have been obtained that make the  $A_a$  and  $A_v$  maps out of date. The first significant changes were made in 1982 and these changes were later included in the "Appendix to Chapter 1" in the 1988 *Provisions*. In the 1991 *Provisions*, that appendix was revised to introduce new spectral maps and procedures for review and comment. For the 1994 *Provisions*, that appendix was again revised to describe recent and future mapping, design values panel efforts, and improved spectral maps.

For these 1997 *Provisions*, a joint effort involving the BSSC, the Federal Emergency Management Agency (FEMA), and the U.S. Geological Survey (USGS) was conducted to develop both new maps for use in design and new design procedures reflecting the significant advances made in the past 20 years. The BSSC's role in this joint effort was to develop new ground motion maps for use in design and design procedures based on new USGS seismic hazard maps.

The BSSC appointed a 15-member Seismic Design Procedure Group (SDPG) to develop the seismic ground motion maps and design procedures. The SDPG membership was composed of representatives of different segments of the design community as well as two earth science members designated by the USGS, and the membership was representative of the different geographical regions of the country. Also the BSSC, with input from FEMA and USGS, appointed a five-member Management Committee (MC) to guide the efforts of the SDPG. The MC was geographically balanced insofar as practicable and was composed of two seismic hazard definition experts and three engineering design experts, including the chairman of the 1997 *Provisions* Update Committee (PUC). The SDPG and the MC worked closely with the USGS to define the BSSC mapping needs and to understand how the USGS seismic hazard maps should be used to develop the BSSC seismic ground motion maps and design procedures.

For a brief overview of how the USGS developed its hazard maps, see Appendix B to this *Commentary* volume. A detailed description of the development of the maps is contained in the USGS Open-File Report 96-532, *National Seismic-Hazard Maps: Documentation, June 1996*, by Frank-

el, et al. (1996). The USGS hazard maps also can be viewed and printed from a USGS Internet site at <http://gldage.cr.usgs.gov/eq/html/finmain.shtml>.

The goals of the SDPG were as follows:

1. To replace the existing effective peak acceleration and velocity-related acceleration design maps with new ground motion spectral response maps based on new USGS seismic hazard maps.
2. To develop the new ground motion spectral response maps within the existing framework of the *Provisions* with emphasis on uniform margin against the collapse of structures.
3. To develop design procedures for use with the new ground motion spectral response maps.

### **PURPOSE OF THE *PROVISIONS***

The purpose of the *Provisions* is to present criteria for the design and construction of new structures subject to earthquake ground motions in order to minimize the risk to life for all structures, to increase the expected performance of higher occupancy structures as compared to ordinary structures, and to improve the capability of essential structures to function after an earthquake. To this end, the *Provisions* provides the minimum criteria considered prudent for structures subjected to earthquakes at any location in the United States and its territories. The *Provisions* generally considers property damage as it relates to occupant safety for ordinary structures. For high occupancy and essential structures, damage limitation criteria are more strict in order to better provide for the safety of occupants and the continued functioning of the structure. Some structural and nonstructural damage can be expected as a result of the “design ground motions” because the *Provisions* allows inelastic energy dissipation by utilizing the deformability of the structural system. For ground motions in excess of the design levels, the intent is that there be a low likelihood of collapse. These goals of the *Provisions* are the guiding principles for developing the design maps.

### **POLICY DECISIONS FOR SEISMIC GROUND MOTION MAPS**

The 1997 *Provisions* maps reflect the following policy decisions that depart from past practice and the 1994 *Provisions*:

1. The maps define the maximum considered earthquake ground motion for use in design procedures,
2. The use of the maps for design provide an approximately uniform margin against collapse for ground motions in excess of the design levels in all areas.
3. The maps are based on both probabilistic and deterministic seismic hazard maps, and
4. The maps are response spectra ordinate maps and reflect the differences in the short-period range of the response spectra for the areas of the United States and its territories with different ground motion attenuation characteristics and different recurrence times.

These policy decisions reflect new information from both the seismic hazard and seismic engineering communities that is discussed below.

In the 1994 *Provisions*, the design ground motions were based on an estimated 90 percent probability of not being exceeded in 50 years (about a 500 year mean recurrence interval) (ATC 3-06 1978). The 1994 *Provisions* also recognized that larger ground motions are possible and that the larger motions, although their probability of occurrence during a structure's life is very small, nevertheless can occur at any time. The 1994 *Provisions* also defined a maximum capable earthquake as "the maximum level of earthquake ground shaking that may ever be expected at the building site within the known geologic framework." It was additionally specified that in certain map areas ( $\geq A_a = 0.3$ ), the maximum capable earthquake was associated with a motion that has a 90 percent probability of not being exceeded in 100 years (about a 1000 year mean recurrence interval). In addition to the maximum capable earthquake definition, sample ground motion maps were prepared with 90 percent probabilities of not being exceeded in 250 years (about a 2500 year mean recurrence interval).

Given the wide range in return periods for maximum magnitude earthquakes throughout the United States and its territories (100 years in parts of California to 100,000 years or more in several other locations), current efforts have focused on defining the maximum considered earthquake ground motions for use in design (not the same as the maximum capable earthquake defined in the 1994 *Provisions*). The maximum considered earthquake ground motions are determined in a somewhat different manner depending on the seismicity of an individual region; however, they are uniformly defined as the maximum level of earthquake ground shaking that is considered as reasonable to design structures to resist. Focusing on ground motion versus earthquake size facilitates the development of a design approach that provides an approximately uniform margin against collapse throughout the United States.

As noted above, the 1994 *Provisions* generally uses the notation of 90 percent probability of not being exceeded in a certain exposure time period (50, 100, or 250 years), which can then be used to calculate a given mean recurrence interval (500, 1000, or 2500 years). For the purpose of these 1997 *Provisions*, the single exposure time period of 50 years has been commonly used as a reference period over which to consider loads on structures (after 50 years of use, structures may require evaluation to determine future use and rehabilitation needs). With this in mind, different levels of probability or return period are expressed as percent probability of exceedance in 50 years. Specifically, 10 percent probability of exceedance in 50 years is a mean recurrence interval of about 500 years, 5 percent probability of exceedance in 50 years is a mean recurrence interval of about 1000 years, and 2 percent probability of exceedance in 50 years is a mean recurrence interval of about 2500 years. The above notation is used throughout the *Provisions*.

Review of modern probabilistic seismic hazard results, including the maps prepared by the USGS to support the effort resulting in the 1997 *Provisions*, indicates that the rate of change of ground motion versus probability is not constant throughout the United States. For example, the ground motion difference between the 10 percent probability of exceedance and 2 percent probability of exceedance in 50 years in coastal California is typically smaller than the difference between the two probabilities in less active seismic areas such as the eastern or central United States. Because of these differences, questions were raised concerning whether definition of the ground motion based on a constant probability for the entire United States would result in similar levels of seismic safety for all structures. Figure A1 plots the 0.2 second spectral acceleration normalized at 2 percent probability of exceedance in 50 years versus the annual frequency of exceedance. Figure

A1 shows that in coastal California, the ratio between the 0.2 second spectral acceleration for the 2 and the 10 percent probabilities of exceedance in 50 years is about 1.5 whereas, in other parts of the United States, the ratio varies from 2.0 to 5.0.

In answering the questions, it was recognized that seismic safety is the result of a number of steps in addition to defining the design earthquake ground motions, including the critical items generally defined as proper site selection, structural design criteria, analysis and procedures, detailed design requirements, and construction.

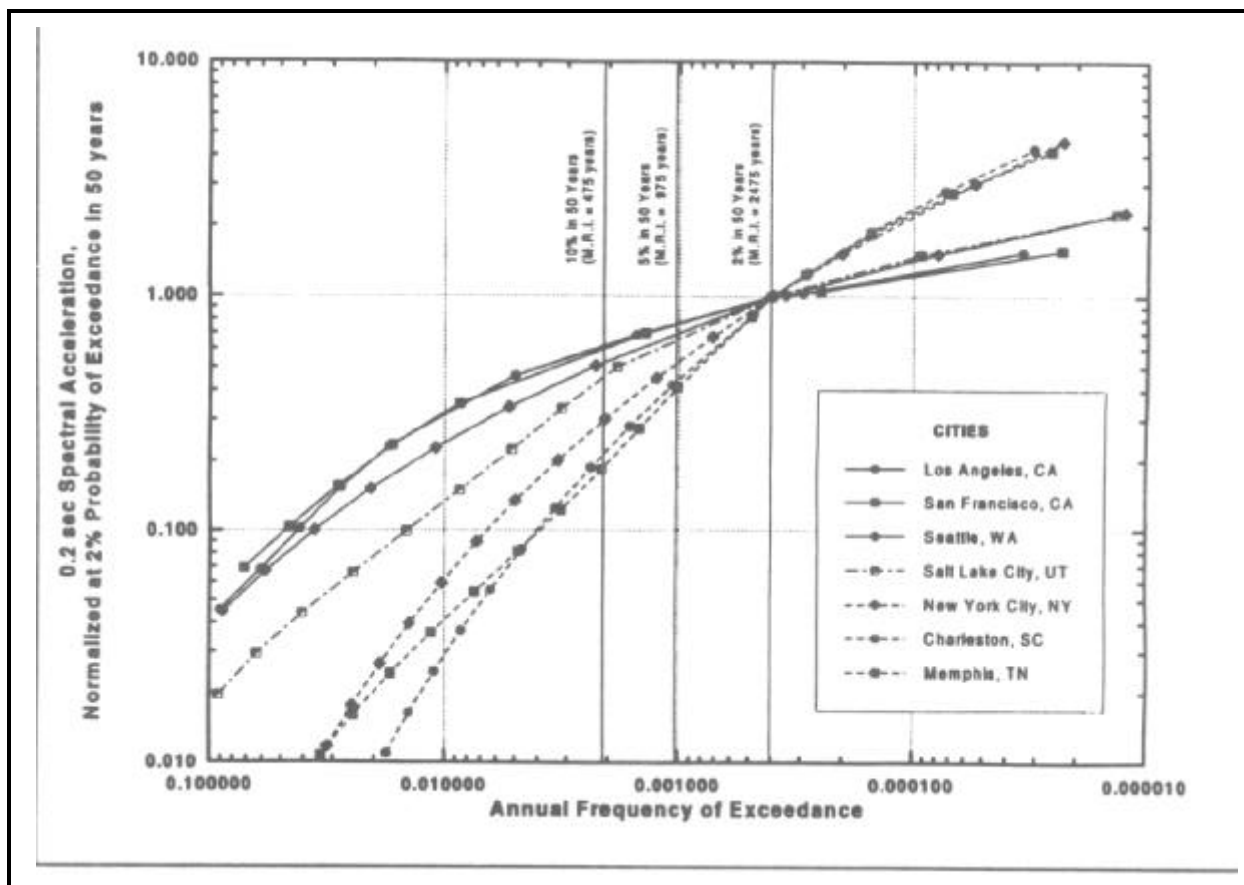

FIGURE A1 Relative hazard at selected sites for 0.2 sec spectral response acceleration. The hazard curves are normalized at 2 percent probability of exceedance in 50 years.

The conservatism in the actual design of the structure is often referred to as the “seismic margin.” It is the seismic margin that provides confidence that significant loss of life will not be caused by actual ground motions equal to the design levels. Alternatively, the seismic margin provides a level of protection against larger, less probable earthquakes although at a lower level of confidence.

The collective opinion of the SDPG was that the seismic margin contained in the *Provisions* provides, as a minimum, a margin of about 1.5 times the design earthquake ground motions. In other words, if a structure experiences a level of ground motion 1.5 times the design level, the structure

should have a low likelihood of collapse. The SDPG recognizes that quantification of this margin is dependent on the type of structure, detailing requirements, etc., but the 1.5 factor is a conservative judgment appropriate for structures designed in accordance with the *Provisions*. This seismic margin estimate is supported by Kennedy et al. (1994), Cornell (1994), and Ellingwood (1994) who evaluated structural design margins and reached similar conclusions.

The USGS seismic hazard maps indicate that in most locations in the United States the 2 percent probability of exceedance in 50 years ground motion values are more than 1.5 times the 10 percent probability of exceedance in 50 years ground motion values. This means that if the 10 percent probability of exceedance in 50 years map was used as the design map and the 2 percent probability of exceedance in 50 years ground motions were to occur, there would be low confidence (particularly in the central and eastern United States) that structures would not collapse due to these larger ground motions. Such a conclusion for most of the United States was not acceptable to the SDPG. The only location where the above results seemed to be acceptable was coastal California (2 percent probability of exceedance in 50 years map is about 1.5 times the 10 percent probability of exceedance in 50 years map) where structures have experienced levels of ground shaking equal to and above the design value.

The USGS probabilistic seismic hazard maps for coastal California also indicate the 10 percent probability of exceedance in 50 years seismic hazard map is significantly different from (in most cases larger) the design ground motion values contained in the 1994 *Provisions*. Given the generally successful experience with structures that comply with the recent editions of the *Uniform Building Code* whose design map contains many similarities to the 1994 *Provisions* design map, the SDPG was reluctant to suggest large changes without first understanding the basis for the changes. This stimulated a detailed review of the probabilistic maps for coastal California. This review identified a unique issue for coastal California in that the recurrence interval of the estimated maximum magnitude earthquake is less than the recurrence interval represented on the probabilistic map, in this case the 10 percent probability of exceedance in 50 years map (i.e., recurrence interval for maximum magnitude earthquake is 100 to 200 years versus 500 years.)

Given the above, one choice was to accept the change and use the 10 percent probability of exceedance in 50 years probabilistic map to define the design ground motion for coastal California and, using this, determine the appropriate probability for design ground motion for the rest of the United States that would result in the same level of seismic safety. This would have resulted in the design earthquake being defined at 2 percent probability of exceedance in 50 years and the need for development of a 0.5 to 1.0 percent probability of exceedance in 50 years map to show the potential for larger ground motions outside of coastal California. Two major problems were identified. The first is that requiring such a radical change in design ground motion in coastal California seems to contradict the general conclusion that the seismic design codes and process are providing an adequate level of life safety. The second is that completing probabilistic estimates of ground motion for lower probabilities (approaching those used for critical facilities such as nuclear power plants) is associated with large uncertainties and can be quite controversial.

An alternative choice was to build on the observation that the maximum earthquake for many seismic faults in coastal California is fairly well known and associated with probabilities larger than a 10 percent probability of exceedance in 50 years (500 year mean recurrence interval). Given this, a decision was made to develop a procedure that would use the best estimate of



ground motion from maximum magnitude earthquakes on seismic faults with high probabilities of occurrence (short return periods). For the purposes of the *Provisions*, these earthquakes are defined as “deterministic earthquakes.” Following this approach and recognizing the inherent seismic margin contained in the *Provisions*, it was determined that the level of seismic safety achieved in coastal California would be approximately equivalent to that associated with a 2 to 5 percent probability of exceedance in 50 years for areas outside of coastal California. In other words, the use of the deterministic earthquakes to establish the maximum considered earthquake ground motions for use in design in coastal California results in a level of protection close to that implied in the 1994 *Provisions* and consistent with maximum magnitude earthquakes expected for those seismic sources. Additionally, this approach results in less drastic changes to ground motion values for coastal California than the alternative approach of using probabilistic based maps.

One could ask why any changes are necessary for coastal California given the positive experience from recent earthquakes. While it is true that the current seismic design practices have produced positive results, the current design ground motions in the 1994 *Provisions* are less than those expected from maximum magnitude earthquakes on known seismic sources. The 1994 *Provisions* reportedly considered maximum magnitude earthquakes but did not directly link them to the design ground motions (Applied Technology Council, 1978). If there is high confidence in the definition of the fault and magnitude of the earthquake and the maximum earthquake occurs frequently, then the design should be linked to at least the best estimate ground motion for such an earthquake. Indeed, it is the actual earthquake experience in coastal California that is providing increased confidence in the seismic margins contained in the *Provisions*.

The above approach also is responsive to comments that the use of 10 percent probability of exceedance in 50 years is not sufficiently conservative in the central and eastern United States where the earthquakes are expected to occur infrequently. Based on the above discussion and the inherent seismic margin contained in the *Provisions*, the SDPG selected 2 percent probability of exceedance in 50 years as the maximum considered earthquake ground motion for use in design where the use of the deterministic earthquake approach discussed above is not used.

The maximum considered earthquake ground motion maps are based on two response spectral values (a short-period and a long-period value) instead of the  $A_a$  and  $A_v$  coefficients. The decision to use response spectral values is based on earthquake data obtained during the past 20 years showing that site-specific spectral values are more appropriate for design input than the  $A_a$  and  $A_v$  coefficients used with standardized spectral shapes. The spectral shapes vary in different areas of the country and for different site conditions. This is particularly the case for the short-period portion of the response spectra. Based on the differences in the ground motion attenuation characteristics between the central and eastern and western United States, the USGS used different ground motion attenuation functions for these areas in developing the seismic hazard maps. The ground motion attenuation functions in the eastern United States result in higher short-period spectral accelerations at lower periods for a given earthquake magnitude than the western United States attenuation functions, particularly compared to the high seismicity region of coastal California. The short-period response spectral values were reviewed in order to determine the most appropriate value to use for the maximum considered earthquake ground motion maps. Based on this review, the short-period spectral response value of 0.2 second was selected to represent the short-period range of the response spectra for the eastern United States. In the western United

States the most appropriate short-period response spectral value was determined to be 0.3 second, but a comparison of the 0.2 and 0.3 second values indicated that the differences in the response spectral values were insignificant. Based on this and for convenience of preparing the maximum considered earthquake ground motion maps, the short-period response spectral value of 0.2 second was selected to represent the short-period range of the response spectra for all of the United States. The long-period response spectral value selected for use is 1.0 second for all of the United States. Based on the ground motion attenuation functions and the USGS seismic hazard maps, a  $1/T$  ( $T$  = natural period) relationship was selected to define the response spectra from the short period value to the long-period value. Using the spectral values from the ground motion maps will allow the different spectral shapes to be incorporated into design.

### **DEVELOPMENT OF THE MAXIMUM CONSIDERED EARTHQUAKE GROUND MOTION MAPS FOR USE IN DESIGN**

The concept for developing maximum considered earthquake ground motions for use in design involved two distinct steps:

1. The various USGS probabilistic seismic hazard maps were combined with deterministic hazard maps by a set of rules (logic) to create the maximum considered earthquake ground motion maps that can be used to define response spectra for use in design and
2. Design procedures were developed that transform the response spectra into design values (e.g., design base shear).

The response spectra defined from the first step represent general “site-dependent” spectra similar to those that would be obtained by a geotechnical study and used for dynamic analysis except their shapes are less refined (i.e., shape defined for only a limited number of response periods). The response spectra do not represent the same hazard level across the country but do represent actual ground motion consistent with providing approximately uniform protection against the collapse of structures. The response spectra represent the maximum considered earthquake ground motions for use in design for Site Class B (rock with a shear wave velocity of 760 meters/second).

The maximum considered earthquake ground motion maps for use in design are based on a defined set of rules for combining the USGS seismic hazard maps to reflect the differences in the ability to define the fault sources and seismicity characteristics across the regions of the country as discussed in the policy decisions. Accommodating regional differences allows the maximum considered earthquake maps to represent ground motions for use in design that provide reasonably consistent margins of preventing the collapse of structures. Based on this, three regions have been defined:

1. Regions of negligible seismicity with very low probability of collapse of the structure,
2. Regions of low and moderate to high seismicity, and
3. Regions of high seismicity near known fault sources with short return periods.

### **Regions of Negligible Seismicity With Very Low Probability of Collapse of the Structure**

The regions of negligible seismicity with very low probability of collapse have been defined by:

1. Determining areas where the seismic hazard is controlled by earthquakes with  $M_b$  (body wave magnitude) magnitudes less than or equal to 5.5 and
2. Examining the recorded ground motions associated with Modified Mercalli Intensity V.

The basis for the first premise is that in this region, there are a number of examples of earthquakes with  $M_b \approx 5.5$  which caused only localized damage to structures not designed for earthquakes. The basis for the second premise is that Modified Mercalli Intensity V ground motions typically do not cause structural damage. By definition, Modified Mercalli Intensity V ground shaking is felt by most people, displaces or upsets small objects, etc., but typically causes no, or only minor, structural damage in buildings of any type. Modified Mercalli Intensity VI ground shaking is felt by everyone, small objects fall off shelves, etc., and minor or moderate structural damage occurs to weak plaster and masonry construction. Life-threatening damage or collapse of *structures* would not be expected for either Modified Mercalli Intensities V or VI ground shaking. Based on an evaluation of 1994 Northridge earthquake data, regions of different Modified Mercalli Intensity (Dewey, 1995) were correlated with maps of smooth response spectra developed from instrumental recordings (Sommerville, 1995). The Northridge earthquake provided a sufficient number of instrumental recordings and associated spectra to permit correlating Modified Mercalli Intensity with response spectra. The results of the correlation determined the average response spectrum for each Modified Mercalli Intensity region. For Modified Mercalli Intensity V, the average response spectrum of that region had a spectral response acceleration of slightly greater than 0.25g at 0.3 seconds and a spectral response acceleration of slightly greater than 0.10g at 1.0 seconds. On the basis of these values and the minor nature of damage associated with Modified Mercalli Intensity V, 0.25g (short-period acceleration) and 0.10g (acceleration at a period of 1 second, taken proportional to  $1/T$ ) is deemed to be a conservative estimate of the spectrum below which life-threatening damage would not be expected to occur even to the most vulnerable of types of structures. Therefore, this region is defined as areas having maximum considered earthquake ground motions with a 2 percent probability of exceedance in 50 years equal to or less than 0.25g (short period) and 0.10g (long period). The seismic hazard in these areas is generally the result of  $M_b \approx 5.5$  earthquakes. In these areas, a minimum lateral force design of 1 percent of the dead load of the structure shall be used in addition to the detailing requirements for the Seismic Design Category A structures.

In these areas it is not considered necessary to specify seismic-resistant design on the basis of a maximum considered earthquake ground motion. The ground motion computed for such areas is determined more by the rarity of the event with respect to the chosen level of probability than by the level of motion that would occur if a small but close earthquake actually did occur. However, it is desirable to provide some protection, both against earthquakes as well as many other types of unanticipated loadings. The requirements for Seismic Design Category A provide a nominal amount of structural integrity that will improve the performance of buildings in the event of a possible, but rare earthquake. The result of design to Seismic Design Category A is that fewer buildings would collapse in the vicinity of such an earthquake.

The integrity is provided by a combination of requirements. First, a complete load path for lateral forces must be identified. Then it must be designed for a lateral force equal to a 1% acceleration on the mass. Lastly, the minimum connection forces specified for Seismic Design Category A must be satisfied.

The 1 percent value has been used in other countries as a minimum value for structural integrity. For many structures, design for the wind loadings specified in the local building codes will normally control the lateral force design when compared to the minimum structural integrity force on the structure. However, many low-rise heavy structures or structures with significant dead loads resulting from heavy equipment may be controlled by the nominal 1 percent acceleration. Also, minimum connection forces may exceed structural forces due to wind in additional structures.

The regions of negligible seismicity will vary depending on the Site Class on which structures are located. The *Provisions* seismic ground motion maps (Maps 1 through 19 ) are for Site Class B conditions and the region of negligible seismicity for Site Class B is defined where the maximum considered earthquake ground motion short-period values are  $\leq 0.25g$  and the long-period values are  $\leq 0.10g$ . The regions of negligible seismicity for the other Site Classes are defined by using the appropriate site coefficients to determine the maximum considered earthquake ground motion for the Site Class and then determining if the short-period values are  $\leq 0.25g$  and the long-period values are  $\leq 0.10g$ . If so, then the site of the structure is located in the region of negligible seismicity for that Site Class.

### **Regions of Low and Moderate to High Seismicity**

In regions of low and moderate to high seismicity, the earthquake sources generally are not well defined and the maximum magnitude estimates have relatively long return periods. Based on this, probabilistic hazard maps are considered to be the best means to represent the uncertainties and to define the response spectra for these regions. The maximum considered earthquake ground motion for these regions is defined as the ground motion with a 2 percent probability of exceedance in 50 years. The basis for this decision is explained in the policy discussion.

Consideration was given to establishing a separate region of low seismicity and defining a minimum level of ground motion (i.e., deterministic minimum ground motions). This was considered because in the transition between the regions of negligible seismicity to the regions of low seismicity, the ground motions are relatively small and may not be very meaningful for use in seismic design. The minimum level was also considered because the uncertainty in the ground motion levels in the regions of low seismicity is larger than in the regions of moderate to high seismicity. This larger uncertainty may warrant consideration of using higher ground motions (or some minimum level of ground motion) than provided by the maximum considered earthquake ground motions shown on the maps.

The studies discussed above for the regions of negligible seismicity by Dewey (1995) and Sommerville (1995), plus other unpublished studies (to date), were evaluated as a means of determining minimum levels of ground motion for used in design. These studies correlated the Modified Mercalli Intensity data with the recorded ground motions and associated damage. The studies included damage information for a variety of structures which had no specific seismic design and determined the levels of ground motion associated with each Modified Mercalli Intensity. These studies indicate that ground motion levels of about 0.50g short-period spectral response and

0.20g long-period spectral response are representative of Modified Mercalli Intensity VII damage.

Modified Mercalli Intensity VII ground shaking results in negligible damage in buildings of good design and construction, slight to moderate damage in well-built ordinary buildings, considerable damage in poorly-built or badly designed buildings, adobe houses, old walls (especially where laid up without mortar), etc. In other words, Modified Mercalli VII ground shaking is about the level of ground motion where significant structural damage may occur and result in life safety concerns for occupants. This tends to suggest that designing structures for ground motion levels below 0.50g short-period spectral response and 0.20g long-period spectral response may not be meaningful.

One interpretation of this information suggests that the ground motion levels for defining the regions of negligible seismicity could be increased. This interpretation would result in much larger regions that require no specific seismic design compared to the 1994 *Provisions*.

Another interpretation of the information suggests establishing a minimum level of ground Motion (at about the Modified Mercalli VII shaking) for regions of low seismicity, in order to transition from the regions of negligible seismicity to the region of moderate to high seismicity. Implementation of a minimum level of ground motion, such as 0.50g for the short-period spectral response and 0.20g for the long-period spectral response, would result in increases (large percentages) in ground motions used for design compared to the 1994 *Provisions*.

Based on the significant changes in past practices resulting from implementing either of the above interpretations, the SDPG decided that additional studies are needed to support these changes. Results of such studies should be considered for future editions of the *Provisions*.

### **Regions of High Seismicity Near Known Fault Sources With Short Return Periods**

In regions of high seismicity near known fault sources with short return periods, deterministic hazard maps are used to define the response spectra maps as discussed above. The maximum considered earthquake ground motions for use in design are determined from the USGS deterministic hazard maps developed using the ground motion attenuation functions based on the median estimate increased by 50 percent. Increasing the median ground motion estimates by 50 percent is deemed to provide an appropriate margin and is similar to some deterministic estimates for a large magnitude characteristic earthquake using ground motion attenuation functions with one standard deviation. Estimated standard deviations for some active fault sources have been determined to be higher than 50 percent, but this increase in the median ground motions was considered reasonable for defining the maximum considered earthquake ground motions for use in design.

### **Maximum Considered Earthquake Ground Motion Maps for Use in Design**

Considering the rules for the three regions discussed above, the maximum considered earthquake ground motion maps for use in design were developed by combining the regions in the following manner:

1. Where the maximum considered earthquake map ground motion values (based on the 2 percent probability of exceedance in 50 years) for Site Class B adjusted for the specific site

conditions are  $\leq 0.25g$  for the short-period spectral response and  $\leq 0.10g$  for the long period spectral response, then the site will be in the region of negligible seismicity and a minimum lateral force design of 1 percent of the dead load of the structure shall be used in addition to the detailing requirements for the Seismic Design Category A structures.

2. Where the maximum considered earthquake ground motion values (based on the 2 percent probability of exceedance in 50 years) for Site Class B adjusted for the specific site conditions are greater than  $0.25g$  for the short-period spectral response and  $0.10g$  for the long-period spectral response, the maximum considered earthquake ground motion values (based on the 2 percent probability of exceedance in 50 years adjusted for the specific site conditions) will be used until the values equal the present (1994 NEHRP) ceiling design values increased by 50 percent (short period =  $1.50g$ , long period =  $0.60g$ ). The present ceiling design values are increased by 50 percent to represent the maximum considered earthquake ground motion values. This will define the sites in regions of low and moderate to high seismicity.
3. To transition from regions of low and moderate to high seismicity to regions of high seismicity with short return periods, the maximum considered earthquake ground motion values based on 2 percent probability of exceedance in 50 years will be used until the values equal the present (1994 *Provisions*) ceiling design values increased by 50 percent (short period =  $1.50g$ , long period =  $0.60g$ ). The present ceiling design values are increased by 50 percent to represent maximum considered earthquake ground motion values. When the 1.5 times the ceiling values are reached, then they will be used until the deterministic maximum considered earthquake map values of  $1.5g$  (long period) and  $0.60g$  (short period) are obtained. From there, the deterministic maximum considered earthquake ground motion map values will be used.

In some cases there are regions of high seismicity near known faults with return periods such that the probabilistic map values (2 percent probability of exceedance in 50 years) will exceed the present ceiling values of the 1994 *Provisions* increased by 50 percent and will be less than the deterministic map values. In these regions, the probabilistic map values will be used for the maximum considered earthquake ground motions.

The basis for using present ceiling design values as the transition between the two regions is because earthquake experience has shown that regularly configured, properly designed *structures* performed satisfactorily in past earthquakes. The most significant structural damage experienced in the Northridge and Kobe earthquakes was related to configuration, structural systems, inadequate connection detailing, incompatibility of deformations, and design or construction deficiencies -- not due to deficiency in strength (Structural Engineers Association of California, 1995). The earthquake designs of the structures in the United States (coastal California) which have performed satisfactorily in past earthquakes were based on the criteria in the *Uniform Building Code*. Considering the site conditions of the structures and the criteria in the *Uniform Building Code*, the ceiling design values for these structures were determined to be appropriate for use with the *Provisions* maximum considered earthquake ground motion maps for Site Class B. Based on this, the equivalent maximum considered earthquake ground motion values for the ceiling were determined to be  $1.50g$  for the short period and  $0.60g$  for the long period.

As indicated above there also are some regions of high seismicity near known fault sources with return periods such that the probabilistic map values (2 percent probability of exceedance in 50

years) will exceed the present ceiling values of the 1994 *Provisions* increased by 50 percent and also be less than the deterministic map values. In these regions, the probabilistic map values will be used for the maximum considered earthquake ground motions.

The near source area in the high seismicity regions is defined as the area where the maximum considered earthquake ground motion values are  $\geq 0.75g$  on the 1.0 second map. In the near source area, *Provisions* Sec. 5.2.3 through 5.2.6 impose additional requirements for certain structures unless the structures are fairly regular, do not exceed 5 stories in height, and do not have a period of vibration over 0.5 seconds. For the fairly regular structures not exceeding 5 stories in height and not having a period of vibration over 0.5 seconds, the maximum considered earthquake ground motion values will not exceed the present ceiling design values increased by 50 percent. The basis for this is because of the earthquake experience discussed above.

These development rules for the maximum considered earthquake ground motion maps for use in design are illustrated in Figures A2 and A3. The application of these rules result in the 1997 *Provision* maximum considered earthquake ground motion maps (Maps 1 through 24).

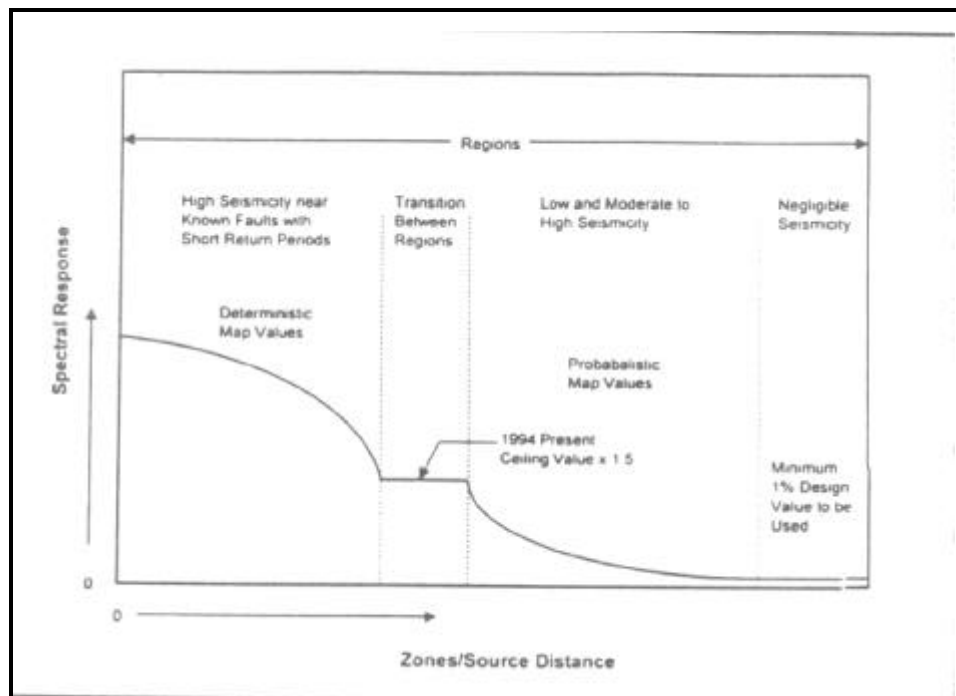

**FIGURE A2** Development of the maximum considered earthquake ground motion map for spectral acceleration of  $T = 1.0$ , Site Class B.

**STEP 1 -- DEFINE POTENTIAL SEISMIC SOURCES**

- A. *Compile Earth Science Information*** -- Compile historic seismicity and fault characteristics including earthquake magnitudes and recurrence intervals.
- B. *Prepare Seismic Source Map*** -- Specify historic seismicity and faults used as sources.

**STEP 2 -- PREPARE PROBABILISTIC AND DETERMINISTIC SPECTRAL RESPONSE MAPS****A. *Develop Regional Attenuation Relations***

- (1) Eastern U.S. (Toro, et al., 1993, and Frankel, 1996)
- (2) Western U.S. (Boore et al., 1993 & 1994, Campbell and Bozorgnia, 1994, and Sadigh, 1993 for PGA. Boore et al., 1993 & 1994, and Sadigh, 1993 for spectral values)
- (3) Deep Events (>35km) (Geomatrix et al., 1993)
- (4) Cascadia Subduction Zone (Geomatrix et al., 1993, and Sadigh, 1993)

**B. *Prepare Probabilistic Spectral Response Maps (USGS Probabilistic Maps)*** -- Maps showing  $S_s$  and  $S_l$  where  $S_s$  and  $S_l$  are the short and 1 second period ground motion response spectral values for a 2 percent chance of exceedence in 50 years inferred for sites with average shear wave velocity of 760 m/s from the information developed in Steps 1A and 1B and the ground motion attenuation relationships in Step 2A.

**C. *Prepare Deterministic Spectral Response Maps (USGS Deterministic Maps)*** -- Maps showing  $S_s$  and  $S_l$  for faults and maximum earthquakes developed in Steps 1A and 1B and the median ground motion attenuation relations in Step 2A increased by 50% to represent the uncertainty.

**STEP 3 -- PREPARE EARTHQUAKE GROUND MOTION SPECTRAL RESPONSE MAPS FOR PROVISIONS (MAXIMUM CONSIDERED EARTHQUAKE GROUND MOTION MAP)****Region 1 -- Regions of Negligible Seismicity with Very Low Probability of Collapse of the Structure (No Spectral Values)**

**Region definition:** Regions for which  $S_s < 0.25g$  and  $S_l < 0.10g$  from Step 2B.

**Design values:** No spectral ground motion values required. Use a minimum lateral force level of 1 percent of the dead load for Seismic Design Category A.

**Region 2 -- Regions of Low and Moderate to High Seismicity (Probabilistic Map Values)**

**Region definition:** Regions for which  $0.25g < S_s < 1.5g$  and  $0.25g < S_l < 0.60g$  from Step 2B.

**Maximum considered earthquake map values:** Use  $S_s$  and  $S_l$  map values from Step 2B.

Transition Between Regions 2 and 3 - Use MCE values of  $S_s = 1.5g$  and  $S_l = 0.60g$

**Region 3 -- Regions of High Seismicity Near Known Faults (Deterministic Values)**

**Region definition:** Regions for which  $1.5g < S_s$  and  $0.60g < S_l$  from Step 2C.

**Maximum considered earthquake map values:** Use  $S_s$  and  $S_l$  map values from Step 2C.

**FIGURE A3 Methodology for development of the maximum considered earthquake ground motion maps (Site Class B).**



**Use of the Maximum Considered Earthquake Ground Motion Maps in the Design Procedure:** The 1994 *Provisions* define the seismic base shear as a function of the outdated effective peak velocity-related acceleration  $A_v$ , and effective peak acceleration,  $A_a$ . For the 1997 *Provisions*, the base shear of the structure is defined as a function of the maximum considered earthquake ground motion maps where  $S_s$  = maximum considered earthquake spectral acceleration in the short-period range for Site Class B;  $S_l$  = maximum considered earthquake spectral acceleration at the 1.0 second period for Site Class B;  $S_{MS} = F_a S_s$ , maximum considered earthquake spectral acceleration in the short-period range adjusted for Site Class effects where  $F_a$  is the site coefficient defined in *Provisions* Sec. 4.1.2.4;  $S_{Ml} = F_v S_l$ , maximum considered earthquake spectral acceleration at 1.0 second period adjusted for Site Class effects where  $F_v$  is the site coefficient defined in *Provisions* Sec. 4.1.2.4;  $S_{DS} = (2/3) S_{MS}$ , spectral acceleration in the short-period range for the design ground motions; and  $S_{Dl} = (2/3) S_{Ml}$ , spectral acceleration at 1.0 second period for the design ground motions.

As noted above, the design ground motions  $S_{DS}$  and  $S_{Dl}$  are defined as 2/3 times the *maximum considered earthquake* ground motions. The 2/3 factor is based on the estimated seismic margins in the design process of the *Provisions* as previously discussed (i.e., the design level of ground motion is 1/1.5 or 2/3 times the maximum considered earthquake ground motion).

Based on the above defined ground motions, the base shear is:

$$V = C_s W$$

where  $C_s = \frac{S_{DS}}{R/I}$  and  $S_{DS}$  = the design spectral response acceleration in the short period range as determined from Sec. 4.1.2.5,  $R$  = the response modification factor from Table 5.2.2, and  $I$  = the occupancy importance factor determined in accordance with Sec. 1.4.

The value of  $C_s$  need not exceed  $C_s = \frac{S_{Dl}}{T(R/I)}$  but shall not be taken less than

$$C_s = 0.1 S_{Dl} \text{ or, for buildings and structures in Seismic Design Categories E and F,}$$

$$C_s = \frac{0.5 S_l}{R/I} \text{ where } I \text{ and } R \text{ are as defined above and } S_{Dl} = \text{the design spectral response accel-}$$

ation at a period of 1.0 second as determined from Sec. 4.1.2.5,  $T$  = the fundamental period of the structure (sec) determined in Sec. 5.3.3, and  $S_l$  = the mapped maximum considered earthquake spectral response acceleration determined in accordance with Sec. 4.1.

Where a design response spectrum is required by these *Provisions* and site-specific procedures are not used, the design response spectrum curve shall be developed as indicated in Figure A4 and as follows:

1. For periods less than or equal to  $T_0$ , the design spectral response acceleration,  $S_a$ , shall be taken as given by Eq. 4.1.2.6-1:

$$S_a = 0.6 \frac{S_{DS}}{T_0} T + 0.4 S_{DS} \quad 1) \quad (4.1.2.6-$$

2. For periods greater than or equal to  $T_0$  and less than or equal to  $T_S$ , the design spectral response acceleration,  $S_a$ , shall be taken as equal to  $S_{DS}$ .
3. For periods greater than  $T_S$ , the design spectral response acceleration,  $S_a$ , shall be taken as given by Eq. 4.1.2.6-3:

$$S_a = \frac{S_{D1}}{T} \quad (4.1.2.6-3)$$

where:

$S_{DS}$  = the design spectral response acceleration at short periods;

$S_{D1}$  = the design spectral response acceleration at 1 second period;

$T$  = the fundamental period of the *structure* (sec);

$T_0 = 0.2 S_{D1} / S_{DS}$ ; and

$T_S = S_{D1} / S_{DS}$ .

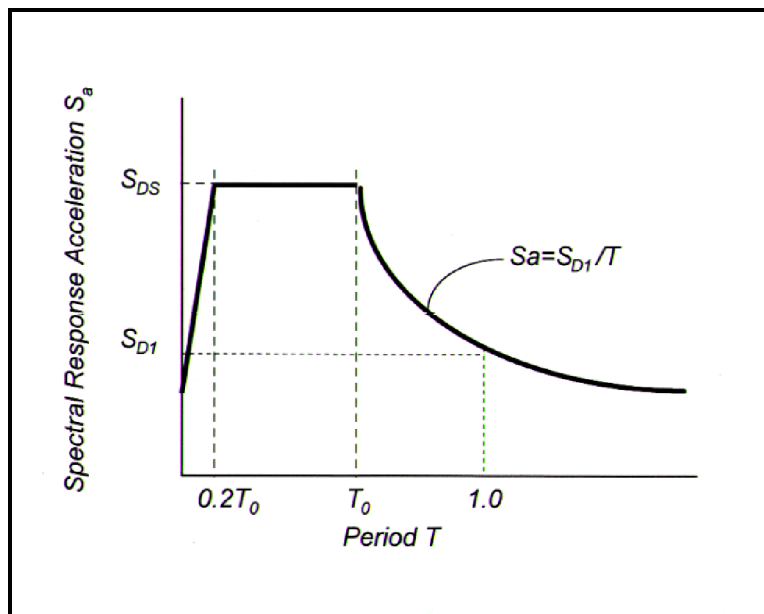

Figure A4 Design response spectrum.

Site-specific procedures for determining ground motions and response spectra are discussed in Sec. 4.1.3 of the *Provisions*.

## REFERENCES

- Applied Technology Council. 1978. *Tentative Provisions for the Development of Seismic Regulations for Building*, Report ATC-3-06. Redwood City, California: Applied Technology Council.
- Structural Engineers Association of California. 1995. *Vision 2000, Performance Based Seismic Engineering of Buildings*. Prepared by the Structural Engineers Association of California, Vision 2000 Committee, for the California Office of Emergency Services.
- Kennedy, R. P. and S. A. Short. 1994. *Basis for Seismic Provisions of DOE-STD-1020*, UCRL-CR-111478. Prepared for Lawrence Livermore National Laboratory. Livermore: University of California.
- Ellingwood, B. R. 1994. "Probability-based Codified Design for Earthquakes." *Engineering Structures* 17(7).
- Cornell, C. A. 1994. *Risk-Based Structural Design, Proceedings of Symposium on Risk Analysis*, Ann Arbor: University of Michigan.
- Dewey, J. W., B. G. Reagor, L. Dengler, and K. Moley. 1995. *Intensity Distribution and Isoseismal Maps for the Northridge, California, Earthquake of January 17, 1994*, U. S. Geological Survey Open-File Report 95-92.
- Sommerville, P. 1995. "Smooth Site Response Spectra Contours Developed for ATC-33," Appendix B of *Guidelines for Seismic Rehabilitation of Existing Buildings, Northridge Earthquake Case-Study Report*, ATC-33-1. Redwood City, California: Applied Technology Council.
- Frankel, et al. 1996. *National Seismic-Hazard Maps: Documentation, June 1996*, U.S. Geological Survey Open-File Report 96-532.

## ***Commentary Appendix B***

### **DEVELOPMENT OF THE USGS SEISMIC MAPS**

#### **INTRODUCTION**

The 1997 *NEHRP Recommended Provisions* uses new design procedures based on the use of spectral response acceleration rather than the traditional peak ground acceleration and/or peak ground velocity. The use of spectral ordinates and their relationship to building codes has been described by Leyendecker et al (1995). The spectral response accelerations used in the new design approach are obtained from combining probabilistic maps (Frankel, et al, 1996) prepared by the U.S. Geological Survey (USGS) with deterministic maps using procedures developed by the Building Seismic Safety Council's Seismic Design Procedures Group (SDPG). The SDPG recommendations are based on using the 1996 USGS probabilistic hazard maps with additional modifications based on review by the SDPG and the application of engineering judgement. This appendix summarizes the development of the USGS maps and describes how the 1997 *Provisions* design maps were prepared from them using SDPG recommendations. The SDPG effort has sometimes been referred to as Project '97.

#### **DEVELOPMENT OF PROBABILISTIC MAPS FOR THE UNITED STATES**

New seismic hazard maps for the conterminous United States were completed by the USGS in June, 1996 and placed on the Internet World Wide Web (<http://geohazards.cr.usgs.gov/eq/>). The color maps can be viewed on the Web and/or downloaded to the user's computer for printing. Paper copies of the maps are also available (Frankel et al, 1997a, 1997b).

New seismic hazard maps for Alaska were completed by the USGS in January 1998 and placed on the USGS web site (<http://geohazards.cr.usgs.gov/eq/>). Both documentation and printing of the maps are in progress (U. S. Geological Survey, 1998a, 1998b).

New probabilistic maps are in preparation for Hawaii using the methodology similar to that used for the rest of the United States. and described below. These maps will be to be completed in early 1998. Probabilistic maps for Puerto Rico, Culebra, Vieques, St. Thomas, St. John, St. Croix, Guam, and Tutuila needed for the 1997 *Provisions* are not expected during the current cycle of USGS map revisions (development of design maps for these areas is described below).

This appendix provides a brief description of the USGS seismic hazard maps, the geologic/seismologic inputs to these maps, and the ground-motion relations used for the maps. It is based on the USGS map documentation for the central and eastern United States (CEUS) and the western United States prepared by Frankel et al (1996). The complete reference document, also available on the USGS Web site, should be reviewed for detailed technical information.

The hazard maps depict probabilistic ground acceleration and spectral response acceleration with 10 percent, 5 percent, and 2 percent probabilities of exceedance (PE) in 50 years. These maps

correspond to return times of approximately 500, 1000, and 2500 years, respectively.\* All spectral response values shown in the maps correspond to 5 percent of critical damping. The maps are based on the assumption that earthquake occurrence is Poissonian, so that the probability of occurrence is time-independent. The methodologies used for the maps were presented, discussed, and substantially modified during 6 regional workshops for the conterminous United States convened by the USGS from June 1994-June 1995. A seventh workshop for Alaska was held in September 1996.

The methodology for the maps (Frankel et al., 1996) includes three primary features:

1. The use of smoothed historical seismicity is one component of the hazard calculation. This is used in lieu of source zones used in previous USGS maps. The analytical procedure is described in Frankel (1995).
2. Another important feature is the use of alternative models of seismic hazard in a logic tree formalism. For the central and eastern United States (CEUS), different models based on different reference magnitudes are combined to form the hazard maps. In addition, large background zones based on broad geologic criteria are used as alternative source models for the CEUS and the western United States (WUS). These background zones are meant to quantify hazard in areas with little historic seismicity, but with the potential to produce major earthquakes. The background zones were developed from extensive discussions at the regional workshops.
3. For the WUS, a big advance in the new maps is the use of geologic slip rates to determine fault recurrence times. Slip rates from about 500 faults or fault segments were used in preparing the probabilistic maps.

The hazard maps do not consider the uncertainty in seismicity or fault parameters. Preferred values of maximum magnitudes and slip rates were used instead. The next stage of this effort is the quantification of uncertainties in hazard curves for selected sites. These data will be included on the Internet as they become available.

The USGS hazard maps are not meant to be used for Mexico, areas north of 49 degrees north latitude, and offshore the Atlantic and Gulf of Mexico coasts of the United States.

### **CEUS and WUS Attenuation Boundary**

Attenuation of ground motion differs between the CEUS and the WUS. The boundary between regions was located along the eastern edge of the Basin and Range province (Figure B1). The

---

\* Previous USGS maps (e.g. Algermissen, et al, 1990 and Leyendecker, et al, 1995) and earlier editions of the *Provisions* expressed probability as a 10 percent probability of exceedance in a specified exposure time. Beginning with the 1996 maps, probability is being expressed as a specified probability of exceedance in a 50 year time period. Thus, 5 percent in 50 years and 2 percent in 50 years used now correspond closely to 10 percent in 100 years and 10 percent in 250 years, respectively, that was used previously. This same information may be conveyed as annual frequency. In this approach 10 percent probability of exceedance (PE) in 50 years corresponds to an annual frequency of exceedance of 0.0021; 5 percent PE in 100 years corresponds to 0.00103; and 2 percent PE in 50 years corresponds to 0.000404.

---

previous USGS maps (e.g., Algermissen et al., 1990) used an attenuation boundary further to the east along the Rocky Mountain front.

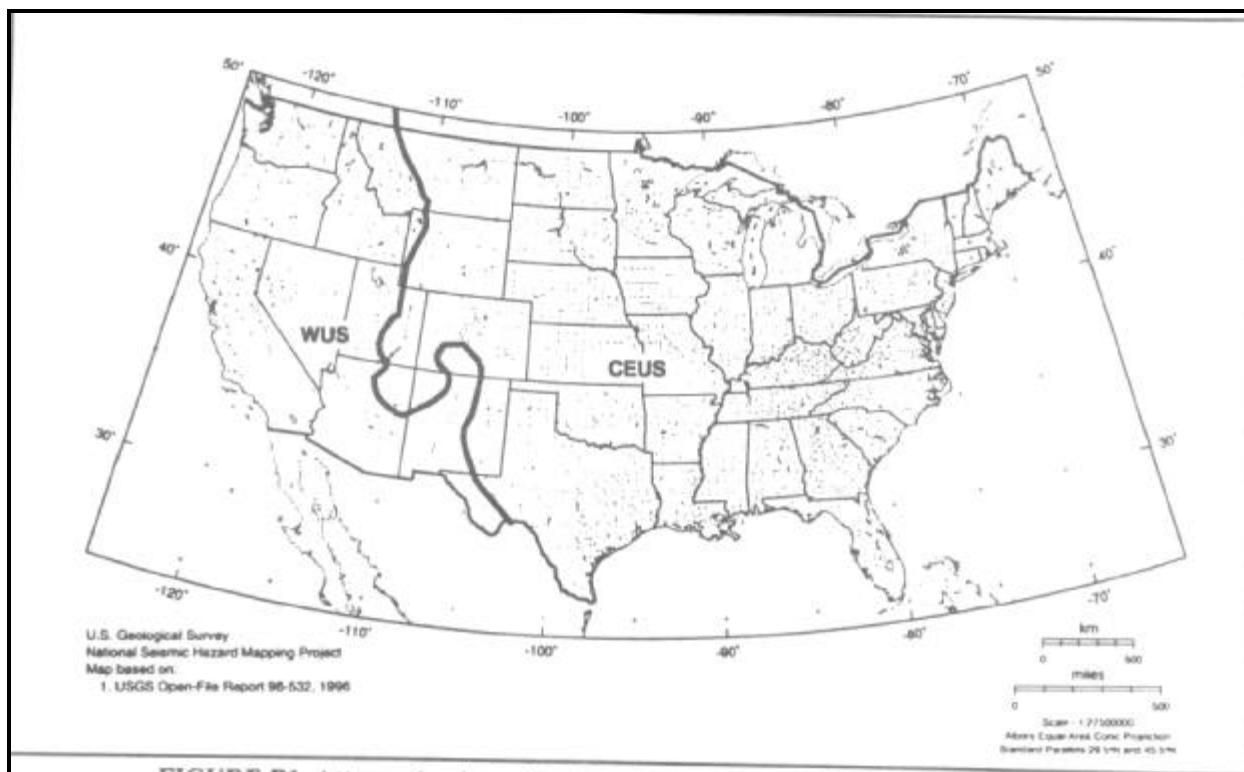

**FIGURE B1 Attenuation boundary for eastern and western attenuation function.**

Separate hazard calculations were done for the two regions using different attenuation relations. Earthquakes west of the boundary used the WUS attenuation relations and earthquakes east of the boundary used CEUS attenuation relations. WUS attenuation relations were used for WUS earthquakes, even for sites located east of the attenuation boundary. Similarly CEUS attenuations were used for CEUS earthquakes, even for sites located west of the attenuation boundary. It would have been computationally difficult to consider how much of the path was contained in the attenuation province. Also, since the attenuation relation is dependent on the stress drop, basing the relation that was used on the location of the earthquake rather than the receiver is reasonable.

### **Hazard Curves**

The probabilistic maps were constructed from mean hazard curves, that is the mean probabilities of exceedance as a function of ground motion or spectral response. Hazard curves were obtained for each site on a calculation grid.

A grid (or site) spacing of 0.1 degrees in latitude and longitude was used for the WUS and 0.2 degrees for the CEUS. This resulted in hazard calculations at about 65,000 sites for the WUS runs and 35,000 sites for the CEUS runs. The CEUS hazard curves were interpolated to yield a set of hazard curves on a 0.1 degree grid. A grid of hazard curves with 0.1 degree spacing was thereby obtained for the entire conterminous United States. A special grid spacing of 0.05 de-

grees was also done for California, Nevada, and western Utah because of the density of faults warranted increased density of data. These data were used for maps of this region.

Figure B2 is a sample of mean hazard curves used in making the 1996 maps. The curves include cities from various regions in the United States. It should be noted that in some areas the curves are very sensitive to the latitude and longitude selected. A probabilistic map is a contour plot of the ground motion or spectral values obtained by taking a “slice” through all 150,000 hazard curves at a particular probability value. The gridded data obtained from the hazard curves that was used to make each probabilistic map is located at the USGS Web site. Figure B2 also shows the general difference in slope of the hazard curves of the CEUS versus the WUS. This difference has been noted in other studies.

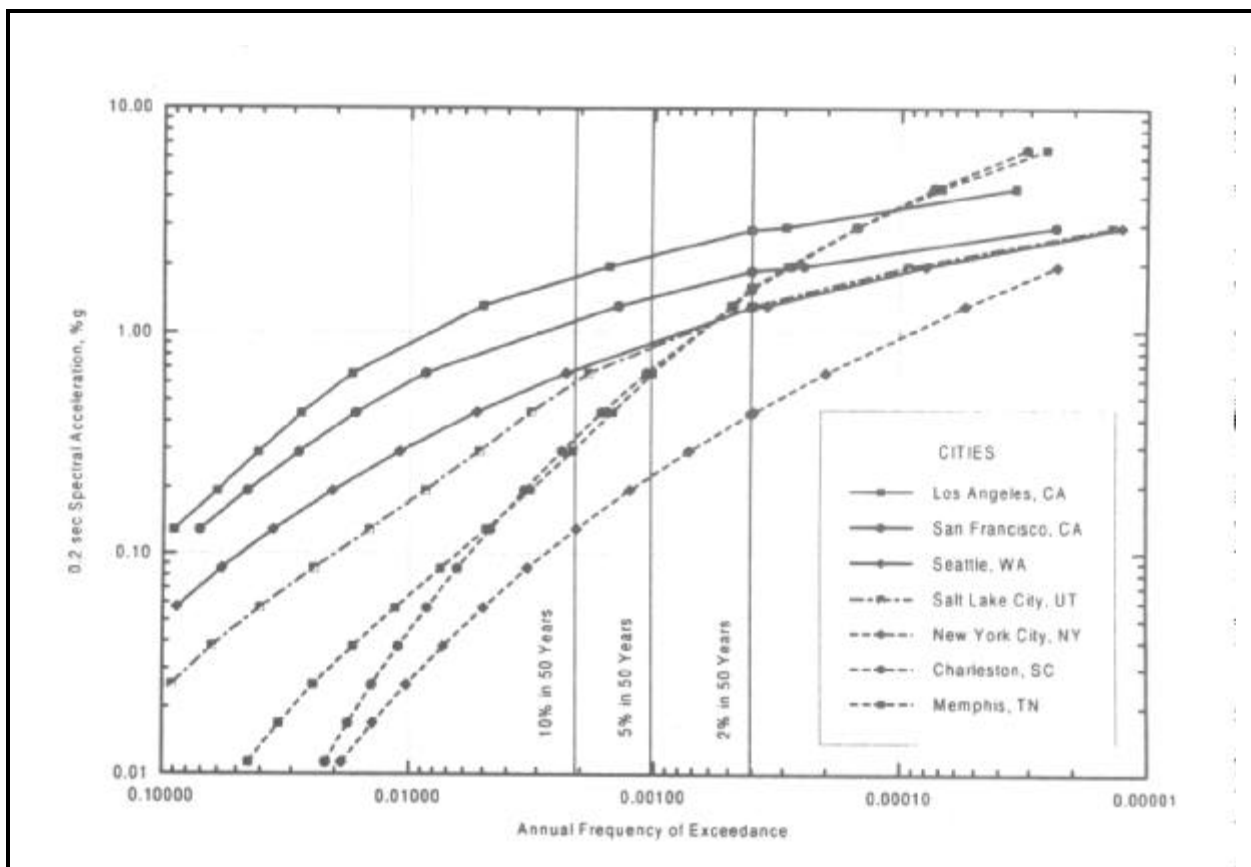

FIGURE B2 Hazard curves for selected cities.

### CENTRAL AND EASTERN UNITED STATES

The basic procedure for constructing the CEUS portion of the hazard maps is diagrammed in Figure B3. Four models of hazard are shown on the left side of the figure. Model 1 is based on  $m_b$  3.0 and larger earthquakes since 1924. Model 2 is derived from  $m_b$  4.0 and larger earthquakes since 1860. Model 3 is produced from  $m_b$  5.0 and larger events since 1700. In constructing the hazard maps, model 1 was assigned a weight twice that of models 2 and 3.

The procedure described by Frankel (1995) is used to construct the hazard maps directly from the historic seismicity (models 1 - 3). The number of events greater than the minimum magnitude are counted on a grid with spacing of 0.1 degrees in latitude and longitude. The logarithm of this number represents the maximum likelihood a-value for each grid cell. Note that the maximum likelihood method counts a  $m_b$  5 event the same as a  $m_b$  3 event in the determination of a-value. Then the gridded a-values are smoothed using a Gaussian function. A Gaussian with a correlation distance of 50 km was used for model 1 and 75 km for models 2 and 3. The 50 km distance was chosen because it is similar in width to many of the trends in historic seismicity in the CEUS. In addition, it is

comparable to the error in location of  $m_b$  3 events in the period of 1924-1975, before the advent of local seismic networks. A larger correlation distance was used for models 2 and 3 since they include earthquakes further back in time with poorer estimates of locations.

Model 4 consists of large background source zones. This alternative is meant to quantify hazard in areas with little historical seismicity but with the potential to generate damaging earthquakes. These background zones are detailed in a later section of this text. The sum of the weights of models 1-4 is one. For a weighting scheme that is uniform in space, this ensures that the total seismicity rate in the combined model equals the historic seismicity rate. A spatially-varying weighting scheme which slightly exceeds the historic seismicity rate was used in the final map for reasons which are described later.

A regional b-value of 0.95 was used for models 1-4 in all of the CEUS except Charlevoix, Quebec. This b-value was determined from a catalog for events east of 105 degrees W. For the Charlevoix region a b-value of 0.76 was used based on the work of John Adams, Stephen Halchuck and Dieter Weichert of the Geologic Survey of Canada (see Adams et al., 1996).

Figure B4 shows a map of the CEUS  $M_{max}$  values used for models 1-4 (bold M refers to moment magnitude). These  $M_{max}$  zones correspond to the background zones used in model 4. Most of the CEUS is divided into a cratonic region and a region of extended crust. An  $M_{max}$  of 6.5 was used for the cratonic area. A  $M_{max}$  of 7.5 was used for the Wabash Valley zone in keeping with magni-

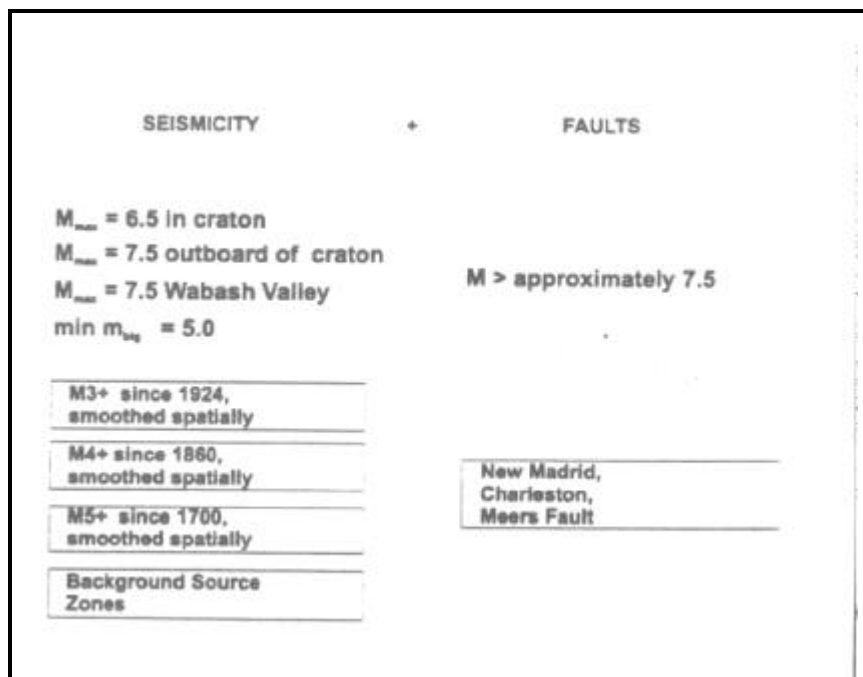
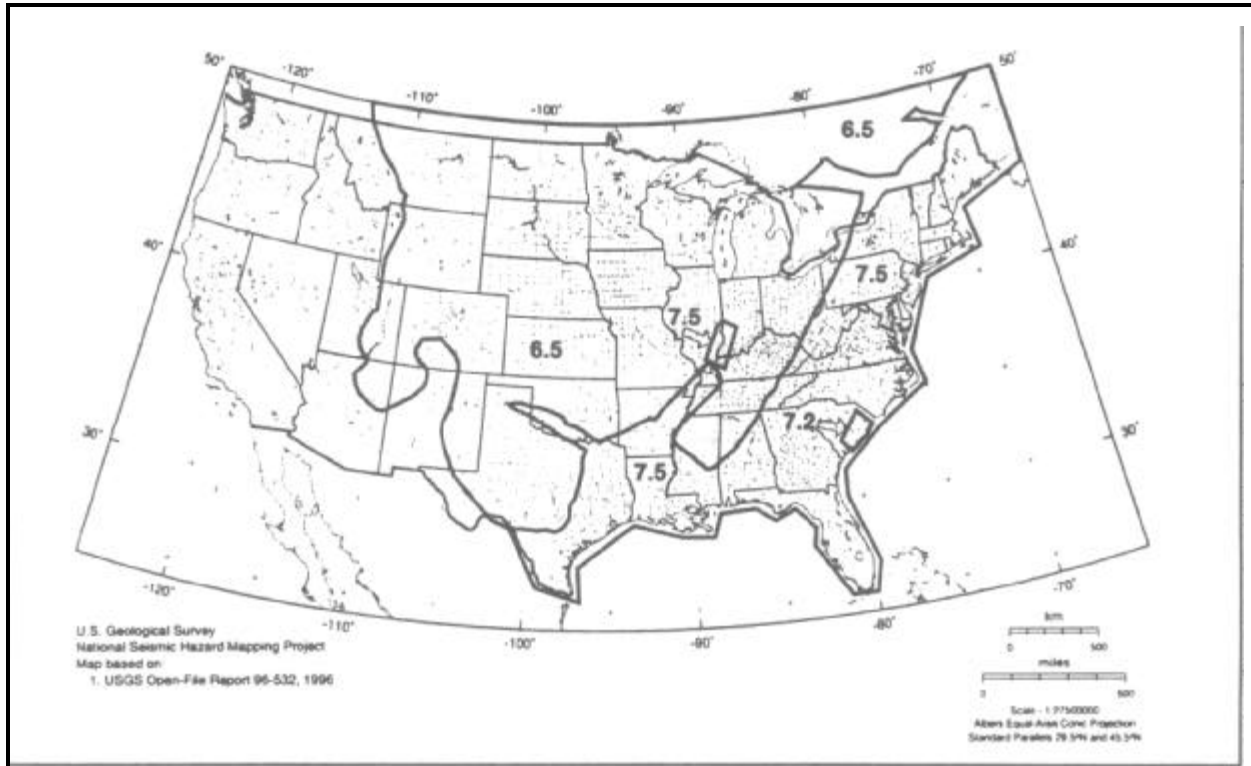

FIGURE B3 Seismic hazard models for the central and eastern United States. Smoothed seismicity models are shown on the left and fault models are shown on the right.



tudes derived from paleoliquefaction evidence (Obermeier et al., 1992). An  $M_{max}$  of 7.5 was used in the zone of extended crust outboard of the craton. An  $M_{max}$  of 6.5 was used for the Rocky Mountain zone and the Colorado Plateau, consistent with the magnitude of the largest historic events in these regions. An  $M_{max}$  of 7.2 was used for the gridded seismicity within the Charleston areal source zone. A minimum  $m_b$  of 5.0 was used in all the hazard calculations for the CEUS.



**FIGURE B4** Central and eastern U.S. maximum magnitude zones.

Model 5 (Figure B3, right) consists of the contribution from large earthquakes ( $M > 7.0$ ) in four specific areas of the CEUS: New Madrid, Charleston, South Carolina, the Meers fault in southwest Oklahoma, and the Cheraw Fault in eastern Colorado. This model has a weight of 1. The treatment of these special areas is described in B.3.1. There are three other areas in the CEUS that are called special zones: eastern Tennessee, Wabash Valley, and Charlevoix. These are described in B.3.1.

### Special Zones

*New Madrid:* To calculate the hazard from large events in the New Madrid area, three parallel faults in an S-shaped pattern encompassing the area of highest historic seismicity were considered. These were not meant to be actual faults; they are simply a way of expressing the uncertainty in the source locations of large earthquakes such as the 1811-12 sequence. A characteristic rupture model with a characteristic moment magnitude  $M$  of 8.0, similar to the estimated magnitudes of the largest events in 1811-12 (Johnston, 1996a,b) was assumed. A recurrence time of 1000 years

for such an event was used as an average value, considering the uncertainty in the magnitudes of pre-historic events.

An areal source zone was used for New Madrid for models 1-3, rather than spatially-smoothed historic seismicity. This zone accounts for the hazard from New Madrid events with moment magnitudes less than 7.5.

*Charleston, South Carolina:* An areal source zone was used to quantify the hazard from large earthquakes. The extent of the areal source zone was constrained by the areal distribution of paleoliquefaction locations, although the source zone does not encompass all the paleoliquefaction sites. A characteristic rupture model of moment magnitude 7.3 earthquakes, based on the estimated magnitude of the 1886 event (Johnston, 1996b) was assumed. For the M7.3 events a recurrence time of 650 years was used, based on dates of paleoliquefaction events (Amick and Gelinias, 1991; Obermeier et al., 1990, Johnston and Schweig, written comm., 1996).

*Meers Fault:* The Meers fault in southwestern Oklahoma was explicitly included. The segment of the fault which has produced a Holocene scarp as described in Crone and Luza (1990) was used. A characteristic moment magnitude of 7.0 and a recurrence time of 4000 years was used based on their work.

*Cheraw Fault:* This eastern Colorado fault with Holocene faulting based on a study by Crone et al. (1996) was included. The recurrence rate of this fault was obtained from a slip rate of 0.5 mm/yr. A maximum magnitude of 7.1 was found from the fault length using the relations of Wells and Coppersmith (1994).

*Eastern Tennessee Seismic Zone:* The eastern Tennessee seismic zone is a linear trend of seismicity that is most obvious for smaller events with magnitudes around 2 (see Powell et al., 1994). The magnitude 3 and larger earthquakes tend to cluster in one part of this linear trend, so that hazard maps are based just on smoothed  $m_b3$ .

*Wabash Valley:* Recent work has identified several paleoearthquakes in the areas of southern Indiana and Illinois based on widespread paleoliquefaction features (Obermeier et al., 1992). An areal zone was used with a higher  $M_{max}$  of 7.5 to account for such large events. The sum of the gridded a-values in this zone calculated from model 1 produce a recurrence time of 2600 years for events with  $m_b$  6.5. The recurrence rate of M6.5 and greater events is estimated to be about 4,000 years from the paleoliquefaction dates (P. Munson and S. Obermeier, pers. comm., 1995), so it is not necessary to add additional large events to augment models 1-3. The Wabash Valley  $M_{max}$  zone in the maps is based on the Wabash Valley fault zone.

*Charlevoix, Quebec:* As mentioned above, a 40 km by 70 km region surrounding this seismicity cluster was assigned a b-value of 0.76, based on the work of Adams, Halchuck and Weichert. This b-value was used in models 1-3.

#### **Background Source Zones (Model 4)**

The background source zones (see Figure B5) are intended to quantify seismic hazard in areas that have not had significant historic seismicity, but could very well produce sizeable earthquakes in the future. They consist of a cratonic zone, an extended margin zone, a Rocky Mountain zone, and a Colorado Plateau zone. The Rocky Mountain zone was not discussed at any workshop, but

is clearly defined by the Rocky Mountain front on the east and the areas of extensional tectonics to the west, north and south. As stated above, the dividing line between the cratonic and extended margin zone was drawn by Rus Wheeler based on the westward and northern edge of rifting during the opening of the Iapetan ocean. One justification for having craton and extended crust zones is the work done by Johnston (1994). They compiled a global survey of earthquakes in cratonic and extended crust and found a higher seismicity rate (normalized by area) for the extended areas.

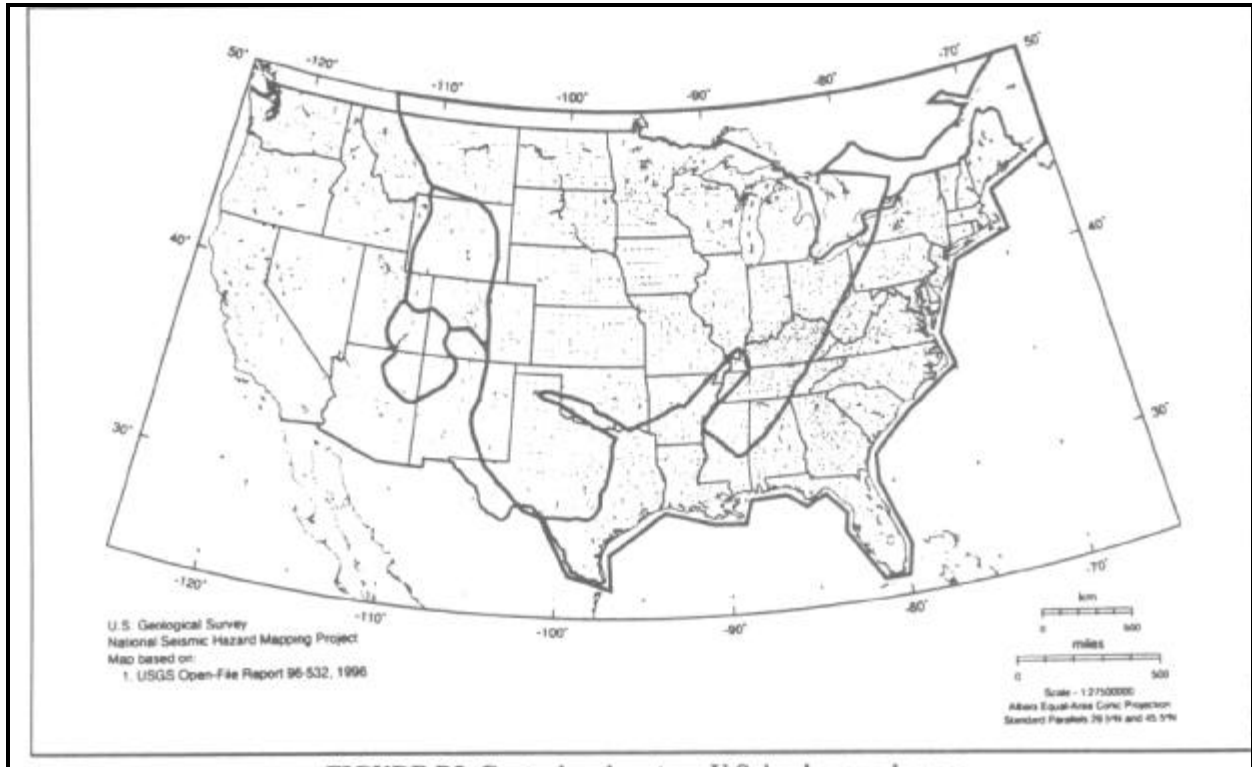

**FIGURE B5** Central and eastern U.S. background zones.

For each background zone, a-values were determined by counting the number of  $m_b \geq 3$  and larger events within the zone since 1924 and adjusting the rate to equal that since 1976. A b-value of 0.95 was used for all the background zones, based on the b-value found for the entire CEUS.

### Adaptive Weighting for CEUS

The inclusion of background zones lowers the probabilistic ground motions in areas of relatively high historic seismicity while raising the hazard to only low levels in areas with no historic seismicity. The June 1996 versions of the maps include the background zones using a weighting scheme that can vary locally depending on the level of historic seismicity in that cell of the a-value grid. Spatially-varying weighting was suggested by Allin Cornell in the external review of the interim maps. The "adaptive weighting" procedure avoids lowering the hazard in higher seismicity areas to raise the hazard in low seismicity areas. This was implemented by looping through the a-value grid and checking to see if the a-value for each cell from the historic seismicity was

greater than the  $a$ -value from the background zone. For the CEUS the  $a$ -value from the historic seismicity was derived by weighting the rates from models 1, 2, and 3 by 0.5, 0.25, 0.25 respectively. If this weighted sum was greater than the rate from the appropriate background zone, then the rate for that cell was determined by weighting the rates from models 1-3 by 0.5, .25, .25 (i.e., historic seismicity only, no background zone). If the weighted sum from the historic seismicity was less than the rate of the background zone, then a weighting of 0.4, 0.2, 0.2, 0.2 for models 1-4, respectively (including the background zone as model 4). This procedure does not make the rate for any cell lower than it would be from the historic seismicity (models 1-3). It also incorporates the background zones in areas of low historic seismicity. The total seismicity rate in the resulting  $a$ -value grid is only 10 percent larger than the observed rate of  $m_b$ 's since 1976. This is not a major difference. Of course, this procedure produces substantially higher ground motions (in terms of percentage increase) in the seismically quiet areas as compared to no background zone. These values are still quite low in an absolute sense.

### **CEUS Catalogs and B-Value Calculation**

The primary catalog used for the CEUS for longitudes east of 105 degrees is Seeber and Armbruster (1991), which is a refinement of the EPRI (1986) catalog. This was supplemented with the PDE catalog from 1985-1995. In addition, PDE, DNAG, Stover and Coffman (1993), Stover, Reagor, and Algermissen (1984) catalogs were searched to find events not included in Seeber and Armbruster (1991). Mueller et al. (1996) describes the treatment of catalogs, adjustment of rates to correct for incompleteness, the removal of aftershocks, and the assignment of magnitudes.

### **Attenuation Relations for CEUS**

The reference site condition used for the maps is specified to be the boundary between NEHRP classes B and C (Martin and Dobry, 1994), meaning it has an average shear-wave velocity of 760 m/sec in the top 30m. This corresponds to a typical "firm-rock" site for the western United States (see WUS attenuation section below), although many rock sites in the CEUS probably have much higher velocities. The motivation for using this reference site is that it corresponds to the average of sites classified as "rock" sites in WUS attenuation relations. In addition, it was considered less problematic to use this site condition for the CEUS than to use a soil condition. Most previously-published attenuation relations for the CEUS are based on a hard-rock site condition. It is less of a problem to convert these to a firm-rock condition than to convert them to a soil condition, since there would be less concern over possible non-linearity for the firm-rock site compared to the soil site.

Two equally-weighted, attenuation relations were used for the CEUS. Both sets of relations were derived by stochastic simulations and random vibration theory. First the Toro et al. (1993) attenuation for hard-rock was used. The attenuation relations were multiplied by frequency-dependent factors developed by USGS to convert them from hard-rock to firm-rock sites. The factors used 1.52 for PGA, 1.76 for 0.2 sec spectral response, 1.72 for 0.3 sec spectral response and 1.34 for 1.0 sec spectral response. These factors were applied independently of magnitude and distance.

The second set of relations was derived by USGS (Frankel et al., 1996) for firm-rock sites. These relations were based on a Brune source model with a stress drop of 150 bars. The simulations

contained frequency-dependent amplification factors derived from a hypothesized shear-wave velocity profile of a CEUS firm-rock site. A series of tables of ground motions and response spectral values as a function of moment magnitude and distance was produced instead of an equation.

For CEUS hazard calculations for models 1-4, a source depth of 5.0 km was assumed when using the USGS ground motion tables. Since a minimum hypocentral distance of 10 km is used in the USGS tables, the probabilistic ground motions are insensitive to the choice of source depth. In the hazard program, when hypocentral distances are less than 10 km the distance is set to 10 km when using the tables. For the Toro et al. (1993) relations, the fictitious depths that they specify for each period are used, so that the choice of source depth used in the USGS tables was not applied.

For both sets of ground motion relations, values of 0.75, 0.75, 0.75 and 0.80 were used for the natural logarithms of the standard deviation of PGA, 0.2 sec, 0.3 sec and 1.0 sec spectral responses, respectively. These values are similar to the aleatory standard deviations reported to the Senior Seismic Hazard Analysis Committee (1996).

A cap in the median ground motions was placed on the ground motions within the hazard code. USGS was concerned that the median ground motions of both the Toro et al. and the new USGS tables became very large (>2.5 g PGA) for distances of about 10 km for the M 8.0 events for New Madrid. Accordingly the median PGA's was capped at 1.5 g. The median 0.3 and 0.2 sec values were capped at 3.75 g which was derived by multiplying the PGA cap by 2.5 (the WUS conversion factor). This only affected the PGA values for the 2 percent PE in 50 year maps for the area directly above the three fictitious faults for the New Madrid region. It does not change any of the values at Memphis. The capping did not significantly alter the 0.3 and 0.2 sec values in this area. The PGA and spectral response values did not change in the Charleston region from this capping. Note that the capping was for the median values only. As the variability (sigma) of the ground motions was maintained in the hazard code, values larger than the median were allowed. USGS felt that the capping recognizes that values derived from point source simulations are not as reliable for M8.0 earthquakes at close-in distances (< 20 km).

#### **Additional Notes for CEUS**

One of the major outcomes of the new maps for the CEUS is that the ground motions are about a factor of 2-3 times lower, on average, than the PGA values in Algermissen et al. (1990) and the spectral values in Algermissen et al. (1991) and Leyendecker et al. (1995). The primary cause of this difference is the magnitudes assigned to pre-instrumental earthquakes in the catalog. Magnitudes of historic events used by Algermissen et al were based on  $I_{\max}$  (maximum observed intensity), using magnitude- $I_{\max}$  relations derived from WUS earthquakes. This overestimates the magnitudes of these events and, in turn, overestimates the rates of M4.9 and larger events. The magnitudes of historic events used in the new maps were primarily derived by Seeber and Armbruster (1991) from either felt area or  $I_{\max}$  using relations derived from CEUS earthquakes (Sibol et al., 1987). Thus, rates of M4.9 and larger events are much lower in the new catalog, compared to those used for the previous USGS maps.

It is useful to compare the new maps to the source zones used in the EPRI (1986) study. For the areas to the north and west of New Madrid, most of the six EPRI teams had three source zones in

common: 1) the Nemaha Ridge in Kansas and Nebraska, 2) the Colorado-Great Lakes lineament extending from Colorado to the western end of Lake Superior, and 3) a small fault zone in northern Illinois, west of Chicago. Each of these source zones are apparent as higher hazard areas in the our maps. The Nemaha Ridge is outlined in the maps because of magnitude 4 and 5 events occurring in the vicinity. Portions of the Colorado-Great Lakes lineament show higher hazard in the map, particularly the portion in South Dakota and western Minnesota. The portion of the lineament in eastern Minnesota has been historically inactive, so is not apparent on the maps. The area in western Minnesota shows some hazard because of the occurrence of a few magnitude 4 events since 1860. A recent paper by Chandler (1995), argues that the locations and focal mechanisms of these earthquakes are not compatible with them being on the lineament, which is expressed as the Morris Fault in this region. The area in northern Illinois has relatively high hazard in the maps because of M4-5 events that have occurred there.

Frankel (1995) also found good agreement in the mean PE's and hazard curves derived from models 1-3 and 4 and those produced by the EPRI (1986) study, when the same PGA attenuation relations were used.

### WESTERN UNITED STATES

The maps for the WUS include a cooperative effort with the California Division of Mines and Geology. This was made possible, in part, because CDMG was doing a probabilistic map at the same time the USGS maps were prepared. There was considerable cooperation in this effort. For example, the fault data base used in the USGS maps was obtained from CDMG. Similarly USGS software was made available to CDMG. The result is that maps produced by both agencies are the same.

The procedure for mapping hazard in the WUS is shown in Figure B6. On the left side, hazards are considered from earthquakes with magnitudes less than or equal to moment magnitude 7.0. For most of the WUS, two alternative models are used: 1) smoothed historical seismicity (weight of 0.67) and 2) large background zones (weight 0.33) based on broad geologic criteria and workshop input. Model 1 used a 0.1 degree source grid to count number of events. The determination of a-value was changed somewhat

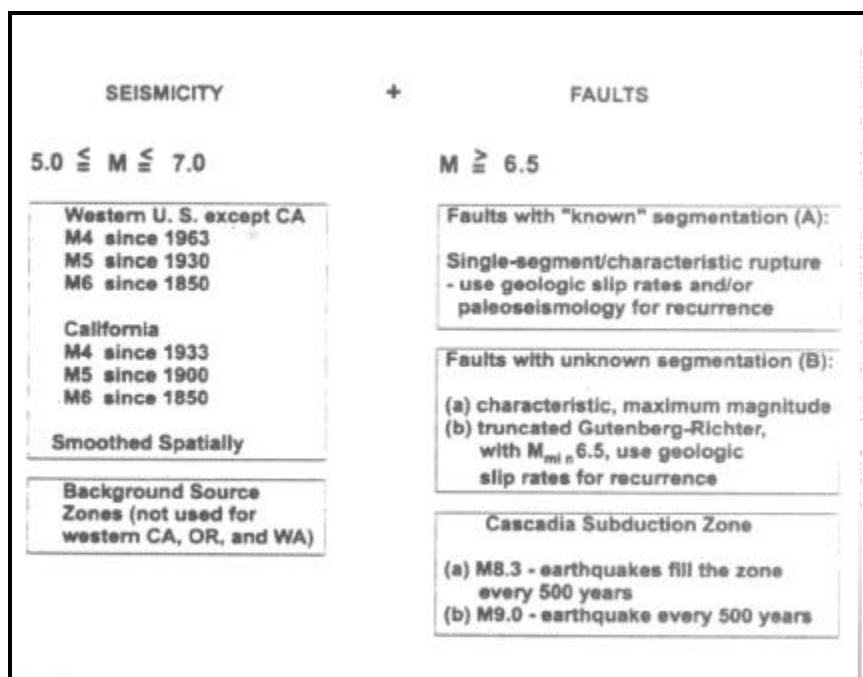

**FIGURE B6** Seismic hazard models for California and the western United States. Smoothed seismicity models are shown on the left and fault models are shown on the right.

from the CEUS, to incorporate different completeness times for different magnitude ranges. The a-value for each grid cell was calculated from the maximum likelihood method of Weichert (1980), based on events with magnitudes of 4.0 and larger. The ranges used were M4.0 to 5.0 since 1963, M5.0 to 6.0 since 1930, and M6.0 and larger since 1850. For the first two categories, completeness time was derived from plots of cumulative number of events versus time. M3 events were not used in the WUS hazard calculations since they are only complete since about 1976 for most areas and may not even be complete after 1976 for some areas. For California M4.0 to M5.0 since 1933, M5.0 to 6.0 since 1900, and M6.0 and larger since 1850 were used. The catalog for California is complete to earlier dates compared to the catalogs for the rest of the WUS (see below).

Another difference with the CEUS is that multiple models with different minimum magnitudes for the a-value estimates (such as models 1-3 for the CEUS) were not used. The use of such multiple models in the CEUS was partially motivated by the observation that some  $m_b4$  and  $m_b5$  events in the CEUS occurred in areas with few  $m_b3$  events since 1924 (e.g., Nemaha Ridge events and western Minnesota events). It was considered desirable to be able to give such  $m_b4$  and  $m_b5$  events extra weight in the hazard calculation over what they would have in one run with a minimum magnitude of 3. In contrast it appears that virtually all M5 and M6 events in the WUS have occurred in areas with numerous M4 events since 1965. There was also reluctance to use a WUS model with a-values based on a minimum magnitude of 6.0, since this would tend to double count events that have occurred on mapped faults included in Figure B6 right.

For model 1, the gridded a-values were smoothed with a Gaussian with a correlation distance of 50 km, as in model 1 for the CEUS. The hazard calculation from the gridded a-values differed from that in the CEUS, because we considered fault finiteness in the WUS calculations. For each source grid cell, a fictitious fault for magnitudes of 6.0 and larger was used. The fault was centered on the center of the grid cell. The strike of the fault was random and was varied for each magnitude increment. The length of the fault was determined from the relations of Wells and Coppersmith (1994). The fictitious faults were taken to be vertical.

A maximum moment magnitude of 7.0 was used for models 1 and 2, except for four shear zones in northeastern California and western Nevada described below. Of course, larger moment magnitudes are included in the specific faults. A minimum moment magnitude of 5.0 were used for models 1 and 2. For each WUS site, the hazard calculation was done for source-site distances of 200 km and less, except for the Cascadia subduction zone, where the maximum distance was 1000 km.

Separate hazard calculations for deep events ( $> 35$  km) were done. These events were culled from the catalogs. Their a-values were calculated separately from the shallow events. Different attenuation relations were used.

Regional b-values were calculated based on the method of Weichert (1980), using events with magnitudes of 4 and larger and using varying completeness times for different magnitudes. Accordingly, a regional b-value of 0.8 was used in models 1 and 2 for the WUS runs based on shallow events. For the deep events ( $>35$  km), an average b-value of 0.65 was found. This low b-value was used in the hazard calculations for the deep events.

We used a b-value of 0.9 for most of California, except for the easternmost portion of California in our basin and range background zone (see below). This b-value was derived by CDMG.

## Faults

The hazard from about 500 Quaternary faults or fault segments was used for the maps. Faults were considered where geologic slip rates have been determined or estimates of recurrence times have been made from trenching studies. A table of the fault parameters used in the hazard calculations has been compiled and is shown on the USGS Internet Web site. Figure B7 shows the faults used in the maps. The numerous individuals who worked on compilations of fault data are too numerous to cite here. They are cited, along with their contribution, in the map documentation (Frankel, et al, 1996).

### Recurrence Models for Faults

The hazard from specific faults is added to the hazard from the seismicity as shown in Figure B6. Faults are divided into types A and B, roughly following the nomenclature of WGCEP (1995). A fault is classified as A-type if there have been sufficient studies of it to produce models of fault segmentation. In California the A-type faults are: San Andreas, San Jacinto, Elsinore, Hayward, Rodgers Creek, and Imperial (M. Petersen, C. Cramer, and W. Bryant, written comm., 1996). The only fault outside of California classified as an A-type is the Wasatch Fault. Single-segment ruptures were assumed on the Wasatch Fault.

For California, the rupture scenarios specified by Petersen, Cramer and Bryant of CDMG, with input from Lienkaemper of USGS for northern California were used. Single-segment, characteristic rupture for the San Jacinto and Elsinore faults were assumed. For the San Andreas fault, multiple-segment ruptures were included in the hazard calculation, including repeats of the 1906 and 1857 rupture zones, and a scenario with the southern San Andreas fault rupturing from San Bernardino through the Coachella segment. Both single-segment and double-segment ruptures of the Hayward Fault were included.

For California faults, characteristic magnitudes derived by CDMG from the fault area using the relations in Wells and Coppersmith (1994) were used. For the remainder of the WUS, the



FIGURE B7 Western U.S. faults included in the maps.



characteristic magnitude was determined from the fault length using the relations of Wells and Coppersmith (1994) appropriate for that fault type.

For the B-type faults, it was felt there were insufficient studies to warrant specific segmentation boundaries. For these faults, the scheme of Petersen et al. (1996) was followed, using both characteristic and Gutenberg-Richter (GR; exponential) models of earthquake occurrence. These recurrence models were weighted equally. The G-R model basically accounts for the possibility that a fault is segmented and may rupture only part of its length. It was assumed that the G-R distribution applies from a minimum moment magnitude of 6.5 up to a moment magnitude corresponding to rupture of the entire fault length.

The procedure for calculating hazard using the G-R model involves looping through magnitude increments. For each magnitude a rupture length is calculated using Wells and Coppersmith (1994). Then a rupture zone of this length is floated along the fault trace. For each site, the appropriate distance to the floating ruptures is found and the frequency of exceedance (FE) is calculated. The FE's are then added for all the floating rupture zones.

As used by USGS, the characteristic earthquake model (Schwartz and Coppersmith, 1984) is actually the maximum magnitude model of Wesnousky (1986). Here it is assumed that the fault only generates earthquakes that rupture the entire fault. Smaller events along the fault would be incorporated by models 1 and 2 with the distributed seismicity or by the G-R model described above.

It should be noted that using the G-R model generally produces higher probabilistic ground motions than the characteristic earthquake model, because of the more frequent occurrence of earthquakes with magnitudes of about 6.5.

Fault widths (except for California) were determined by assuming a seismogenic depth of 15 km and then using the dip, so that the width equaled 15 km divided by the sine of the dip. For most normal faults a dip of 60 degrees is assumed. Dip directions were taken from the literature. For the Wasatch, Lost River, Beaverhead, Lemhi, and Hebgen Lake faults, the dip angles were taken from the literature (see fault parameter table on Web site). Strike-slip faults were assigned a dip of 90 degrees. For California faults, widths were often defined using the depth of seismicity (J. Lienkaemper, written comm., 1996; M. Petersen, C. Cramer, and W. Bryant, written comm., 1996). Fault length was calculated from the total length of the digitized fault trace.

### **Special Cases**

There are a number of special cases which need to be described.

*Blind thrusts in the Los Angeles area:* Following Petersen et al (1996) and as discussed at the Pasadena workshop, 0.5 weight was assigned to blind thrusts in the L.A. region, because of the uncertainty in their slip rates and in whether they were indeed seismically active. These faults are the Elysian Park thrust and the Compton thrust. The Santa Barbara Channel thrust (Shaw and Suppe, 1994) also has partial weight, based on the weighting scheme developed by CDMG.

*Offshore faults in Oregon:* A weight of 0.05 was assigned to three offshore faults in Oregon identified by Goldfinger et al. (in press) and tabulated by Geomatrix (1995): the Wecoma, Daisy Bank and Alvin Canyon faults. It was felt the uncertainty in the seismic activity of these faults

warranted a low weight, and the 0.05 probability of activity decided in Geomatrix (1995) was used. A 0.5 weight was assigned to the Cape Blanco blind thrust.

*Lost River, Lemhi and Beaverhead faults in Idaho:* It was assumed that the magnitude of the Borah Peak event (M7.0) represented a maximum magnitude for these faults. As with (3), the characteristic model floated a M7.0 along each fault. The G-R model considered magnitudes between 6.5 and 7.0. Note that using a larger maximum magnitude would lower the probabilistic ground motions, because it would increase the recurrence time.

*Hurricane and Sevier-Torroweap Faults in Utah and Arizona:* The long lengths of these faults (about 250 km) implied a maximum magnitude too large compared to historical events in the region. Therefore a maximum magnitude of M7.5 was chosen. The characteristic and G-R models were implemented as in case (3). Other faults (outside of California) where the  $M_{\max}$  was determined to be greater than 7.5 based on the fault length were assigned a maximum magnitude of 7.5.

*Wasatch Fault in Utah:* Recurrence times derived from dates of paleoearthquakes by Black et al. (1995) and the compilation of McCalpin and Nishenko (1996) were used

*Hebgen Lake Fault in Montana:* A characteristic moment magnitude of 7.3 based on the 1959 event (Doser, 1985) was used.

*Short faults:* All short faults with characteristic magnitudes of less than 6.5 were treated with the characteristic recurrence model only (weight=1). No G-R relation was used. If a fault had a characteristic magnitude less than 6.0, it was not used.

*Seattle Fault:* The characteristic recurrence time was fixed at 5000 years, which is the minimum recurrence time apparent from paleoseismology (R. Bucknam, pers. comm., 1996). Using the characteristic magnitude of 7.1 derived from the length and a 0.5 mm/yr slip rate yielded a characteristic recurrence time of about 3000 years.

*Eglington fault near Las Vegas:* The recurrence time for this fault was fixed at 14,000 years, similar to the recurrence noted in Wyman et al. (1993).

*Shear Zones in Eastern California and Western Nevada:* Areal shear zones were added along the western border of Nevada extending from the northern end of the Death Valley fault through the Tahoe-Reno area through northeast California ending at the latitude of Klamath Falls, Oregon. A shear rate of 4 mm/yr to zone 1, and 2 mm/yr to zones 2 and 3 was assigned. The shear rate in zone 1 is comparable to the shear rate observed on the Death Valley fault, but which is not observed in mapped faults north of the Death Valley fault (C. dePolo and J. Anderson, pers. comm., 1996). For the Foothills Fault system (zone 4) a shear rate of 0.05 mm/yr was used. a-values were determined for these zones in the manner described in Ward(1994). For zones 1-3, a magnitude range of 6.5-7.3 was used. For zone 4, a magnitude range of 6.0-7 was used. The maximum magnitude for the calculation of hazard from the smoothed historic seismicity was lowered in these zones so that it did not overlap with these magnitude ranges. Fictitious faults with a fixed strike were used in the hazard calculation for these zones. Again, use of these areal zones in California was agreed upon after consultation with CDMG personnel.

### **Cascadia Subduction Zone**

Two alternative scenarios for great earthquakes on the Cascadia subduction zone were considered. For both scenarios it was assumed that the recurrence time of rupture at any point along the subduction zone was 500 years. This time is in or near most of the average intervals estimated from coastal and offshore evidence (see Atwater and Hemphill-Haley, 1996; Geomatrix, 1995; B. Atwater, written comm., 1996). Individual intervals, however, range from a few hundred years to about 1000 years (Atwater et al., 1995).

The first scenario is for moment magnitude 8.3 earthquakes to fill the subduction zone every 500 years. Based on a rupture length of 250 km (see Geomatrix, 1995) for an M8.3 event and the 1100 km length of the entire subduction zone, this requires a repeat time of about 110 years for an M8.3 event. However, no such event has been observed in the historic record of about 150 years. This M8.3 scenario is similar to what was used in the 1994 edition of the USGS maps (see Leyendecker et al., 1995) and it is comparable to the highest weighted scenario in Geomatrix (1995). A M8.3 rupture zone was floated along the strike of the subduction zone to calculate the hazard. A weight of 0.67 was assigned for this scenario in the maps.

The second scenario used is for a moment magnitude 9.0 earthquake to rupture the entire Cascadia subduction zone every 500 years on average. No compelling reason was seen to rule out such a scenario. This scenario would explain the lack of M8s in the historic record. It is also consistent with a recent interpretation of Japanese tsunami records by Satake et al. (1996). By ruling out alternative source regions, Satake et al. (1996) reported that a tsunami in 1700 could have been produced by a M9.0 earthquake along the Cascadia subduction zone. A weight of 0.33 was assigned to the M9.0 scenario in the maps.

The subduction zone was specified as a dipping plane striking north-south from about Cape Mendocino to 50 degrees north. It was assumed that the plane reached 20 km depth at a longitude of 123.8 degrees west, just east of the coastline. This corresponds roughly to the 20 km depth contour drawn by Hyndman and Wang (1995) and is consistent with the depth and location of the Petrolia earthquake in northern California. A dip of 10 degrees was assigned to the plane and a width of 90 km. The seismogenic portion of the plane was assumed to extend to a depth of 20 km.

### **Background Source Zones**

The background source zones for the WUS (model 2) were based on broad geologic criteria and were developed by discussion at the Salt Lake City (SLC) workshop (except for the Cascades source zone). These zones are shown in Figure B8. Note that there are no background source zones west of the Cascades and west of the Basin and Range province. For those areas, model 1 was used with a weight of 1.

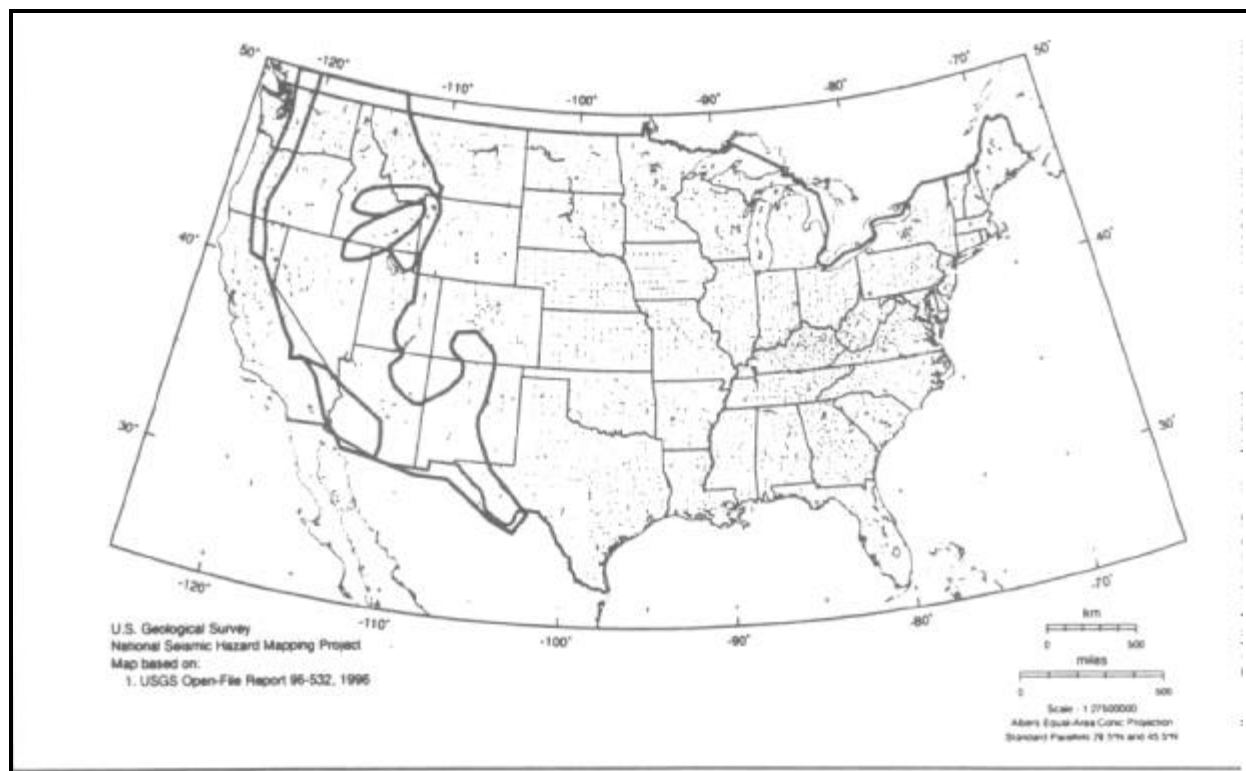

**FIGURE B8** Western U.S. background zones.

At the SLC workshop there was substantial sentiment for a Yellowstone Parabola source zone (see, e.g., Anders et al., 1989) that would join up seismically-active areas in western Wyoming with the source areas of the Bora Peak and Hebgen Lake earthquakes. It was felt that the relatively seismically-quiet areas consisting of the Snake River Plain and Colorado Plateau should be separate source zones because of the geologic characteristics. An area of southwest Arizona was suggested as a separate source zone by Bruce Scheol, based partly on differences in the age and length of geologic structures compared with the Basin and Range Province (see Edge et al., 1992). A Cascades source zone was added since it was felt that was a geologically-distinct area.

The remaining background source zone includes the Basin and Range Province, the Rio Grande Rift, areas of Arizona and New Mexico, portions of west Texas, and areas of eastern Washington and northern Idaho and Montana. The northern border of this zone follows the international border. As stated above, this seems to be a valid approach since the hazard maps are being based on the seismicity rate in the area of interest.

This large background zone is intended to address the possibility of having large earthquakes (M6 and larger) in areas with relatively low rates of seismicity in the brief historic record. It is important to have a large zone that contains areas of high seismicity in order to quantify the hazard in relatively quiet areas such as eastern Oregon and Washington, central Arizona, parts of New Mexico, and west Texas. One can see the effect of this large background zone by noting the contours on the hazard maps in these areas. The prominence of the background zones in the maps is determined by the weighting of models 1 and 2.

## Adaptive Weighting for the WUS

The adaptive weighting procedure was used to include the background zones in the WUS without lowering the hazard values in the high seismicity areas. As with the CEUS, the a-value was checked for each source cell to see whether the rate from the historic seismicity exceeded that from the appropriate background zone. If it did, the a-value was used from the historic seismicity. If the historic seismicity a-value was below the background value, then a rate derived from using 0.67 times the historic rate plus 0.33 times the background rate was used. This does not lower the a-value in any cell lower than the value from the historic seismicity. The total seismicity rate in this portion of the WUS in the new a-value grid is 16 percent above the historic rate (derived from M4 and greater events since 1963).

## WUS Catalogs

For the WUS, except for California, the Stover and Coffman (1993), Stover, Reagor, and Algermissen (1984), PDE, and DNAG catalogs (with the addition of Alan Sanford's catalog for New Mexico) were used. For California, a catalog compiled by Mark Petersen of California Division of Mines and Geology (CDMG) was used. Mueller et al. (1996) describes the processing of the catalogs, the removal of aftershocks, and the assignment of magnitudes. Utah coal-mining events were removed from the catalog (see Mueller et al., 1996). Explosions at NTS and their aftershocks were also removed from the catalog.

## Attenuation Relations for WUS

*Crustal Events:* For spectral response acceleration, three equally-weighted attenuation relations were used: (1) Boore, Joyner, and Fumal (BJF; 1993, 1994a) with later modifications to differentiate thrust and strike-slip faulting (Boore et al., 1994b) and (2) Sadigh et al. (1993). For (1) ground motions were calculated for a site with average shear-wave velocity of 760 m/sec in the top 30m, using the relations between shear-wave velocity and site amplification in Boore et al. (1994a). For (2) their "rock" values were used. Joyner (1995) reported velocity profiles compiled by W. Silva and by D. Boore showing that WUS rock sites basically spanned the NEHRP B/C boundary. When calculating ground motions for each fault, the relations appropriate for that fault type (e.g, thrust) were used. All of the relations found higher ground motions for thrust faults compared with strike slip faults.

All calculations included the variability of ground motions. For 1) the sigma values reported in BJF (1994b) were used. For 2) the magnitude-dependent sigmas found in those studies were used.

The distance measure from fault to site varies with the attenuation relation and this was accounted for in the hazard codes (see B.5 for additional detail on distance measures).

*Deep events (> 35 km):* Most of these events occurred beneath the Puget Sound region, although some were in northwestern California. For these deep events, only one attenuation relation was used -- i.e., by Geomatrix (1993; with recent modification for depth dependence provided by R. Youngs, written comm., 1996) which is based on empirical data of deep events recorded on rock sites. The relations of Crouse (1991) were used because they were for soil sites. It was found that the ground motions from Geomatrix (1993) are somewhat smaller than those from Crouse

(1991), by an amount consistent with soil amplification. These events were placed at a depth of 40 km for calculation of ground motions.

*Cascadia subduction zone:* For M8.3 events on the subduction zone, two attenuation relations (with equal weights) were used following the lead of Geomatrix (1993): 1) Sadigh et al. (1993) for crustal thrust earthquakes and 2) Geomatrix (1993) for interface earthquakes. For the M9.0 scenario, Sadigh et al. (1993) formulas could not be used since they are invalid over M8.5. Therefore, only Geomatrix (1993) was used. Again the values from Geomatrix (1993) were somewhat smaller than the soil values in Crouse (1991).

### ALASKA

The basic procedure, shown in Figure B9, for constructing the Alaska hazard maps is similar to that previously described for the Western United States. The maps have been completed and both the maps and documentation (USGS, 1998a, 1998b) have been placed on the USGS internet site (<http://geohazards.cr.usgs.gov/eq/>); printing of the maps is in progress.

#### Faults

The hazard from nine faults was used for the maps (Figure B10). Faults were included in the map when an estimated slip rate was available. The seismic hazard associated with faults not explicitly included in the map is captured to a large degree by the smoothed seismicity model. Specific details on the fault parameters are given in USGS., 1997a.

All of the faults except one were strike-slip faults.

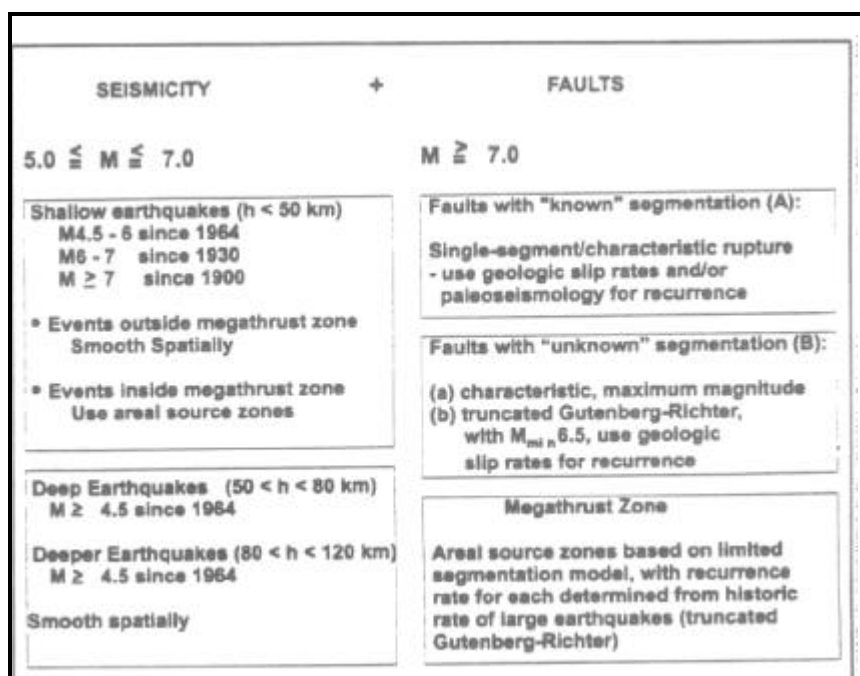
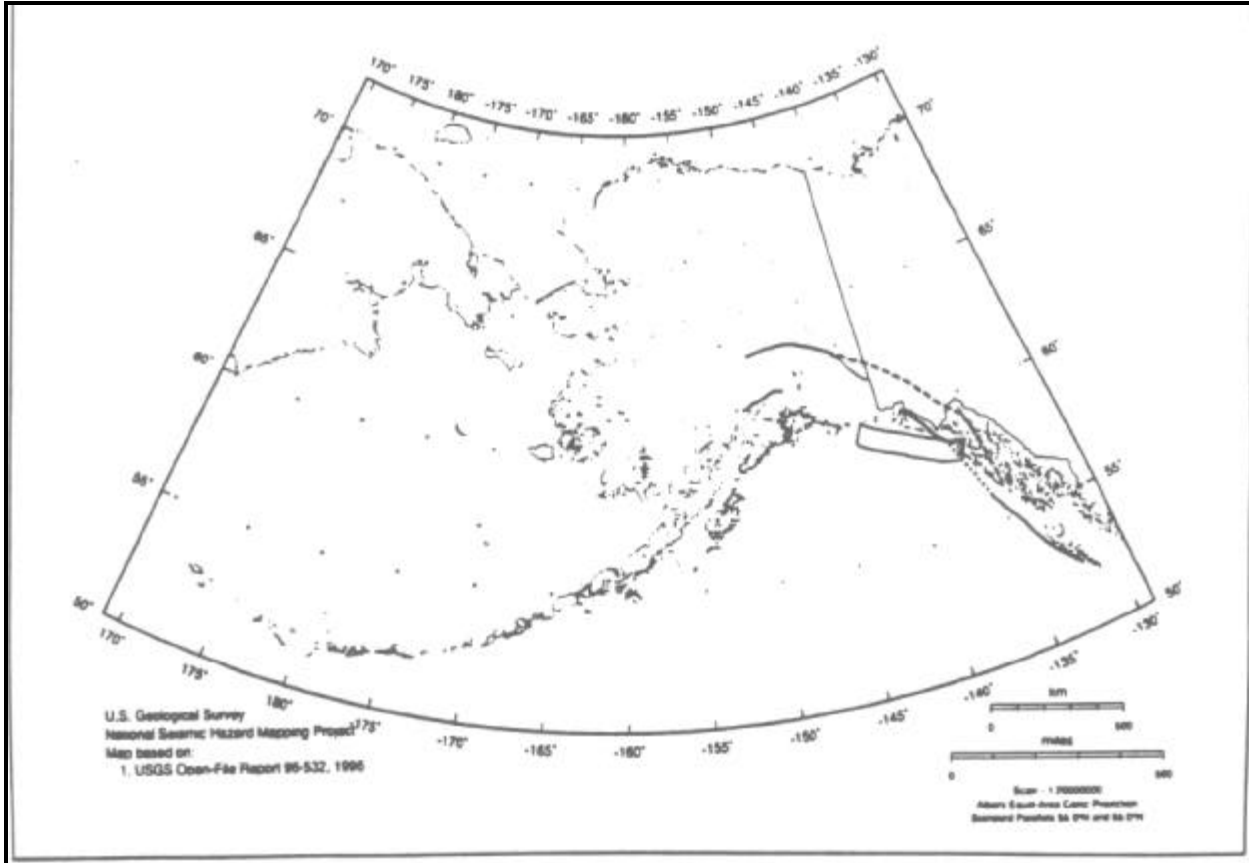

FIGURE B9 Seismic hazard models for Alaska. Smoothed seismicity models are shown on the left and fault models are shown on the right.



**FIGURE B10** Faults included in the maps. Faults are shown with different line types for clarify. Dipping faults are shown as closed polygons.

### Recurrence Models for Faults

As was done for the western U.S., faults were divided into types A and B. The fault treatment was the same as the western U.S. Type A faults were the Queen Charlotte, Fairweather offshore, Fairweather onshore, and Transition fault. Type B faults included western Denali, eastern Denali, Totshunda, and Castle Mountain.

For the type B faults, both characteristic and Gutenberg-Richter (G-R) models of earthquake occurrence were used. These recurrence models were weighted equally. The G-R model accounts for the possibility that a fault is segmented and may rupture only part of its length. It was assumed that the G-R distribution applies from a minimum moment magnitude of 6.5 up to a moment magnitude corresponding to rupture of the entire fault length.

### Special Case

The Transition fault was treated as a Type A fault even though its segmentation is unknown. Although the rationale for this treatment is documented in USGS, 1998a, it should be pointed out that the parameters, such as segmentation and slip rate, associated with this fault are highly uncertain.

## Megathrust

The Alaska-Aleutian megathrust was considered in four parts, shown in Figure B11. Specific rationale for the use of these boundaries is complex and is described in USGS, 1998a.

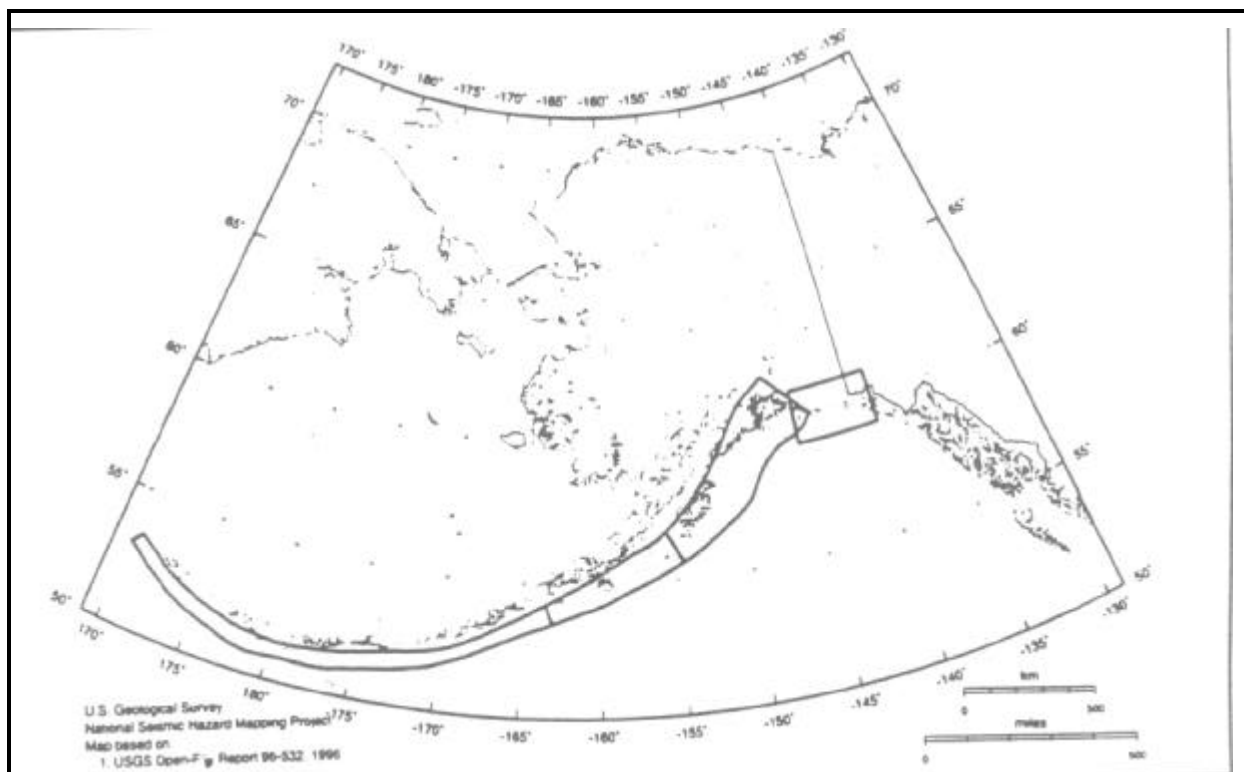

FIGURE B11 Subduction zones included in the maps.

## Alaska Catalogs

A new earthquake catalog was built by combining Preliminary Determination of Epicenter, Decade of North American Geology, and International Seismological Centre catalogs with USGS interpretations of catalog reliability. Mueller et al. (1997) describes the processing of the catalogs, the removal of aftershocks, and the assignment of magnitudes.

### Attenuation Relations for Alaska

*Crustal Events:* For spectral response acceleration, two equally-weighted attenuation relations were used: (1) Boore, Joyner, and Fumal (BJF; 1997) and (2) Sadigh et al. (1997). For (1) ground motions were calculated for a site with average shear-wave velocity of 760 m/sec in the top 30m. For (2) their "rock" values were used. These are recent publication of the attenuations cited for the western U.S. The attenuations are the same. When calculating ground motions for each fault, the relations appropriate for that fault type (e.g, strike slip) were used. All calculations included the variability of ground motions.

*Deep events (50 - 80 km):* For these deep events, only one attenuation relation was used, the intraslab form of Youngs et al (1997) with a depth fixed at 60 km.



*Deeper events (80 - 120 km):* For these deeper events, only one attenuation relation was used, the intraslab form of Youngs et al (1997) with a depth fixed at 90 km.

*Megathrust and Transition Fault:* Only one attenuation relation was used, the interslab form of Youngs et al (1997). It should be noted that the use of this attenuation for the Transition fault resulted in lower ground motions than would have been obtained using the crustal attenuation equations.

### PROBABILISTIC MAPS

Two of the probabilistic maps were key to the decisions made by the SDPG for developing the *maximum considered earthquake* ground motion maps. These are the 0.2 sec and 1.0 sec spectral response maps for a 2 percent probability of exceedance in 50 years. These are shown in Figures 12 and 13 respectively. The way in which these maps were used is described in the following sections.

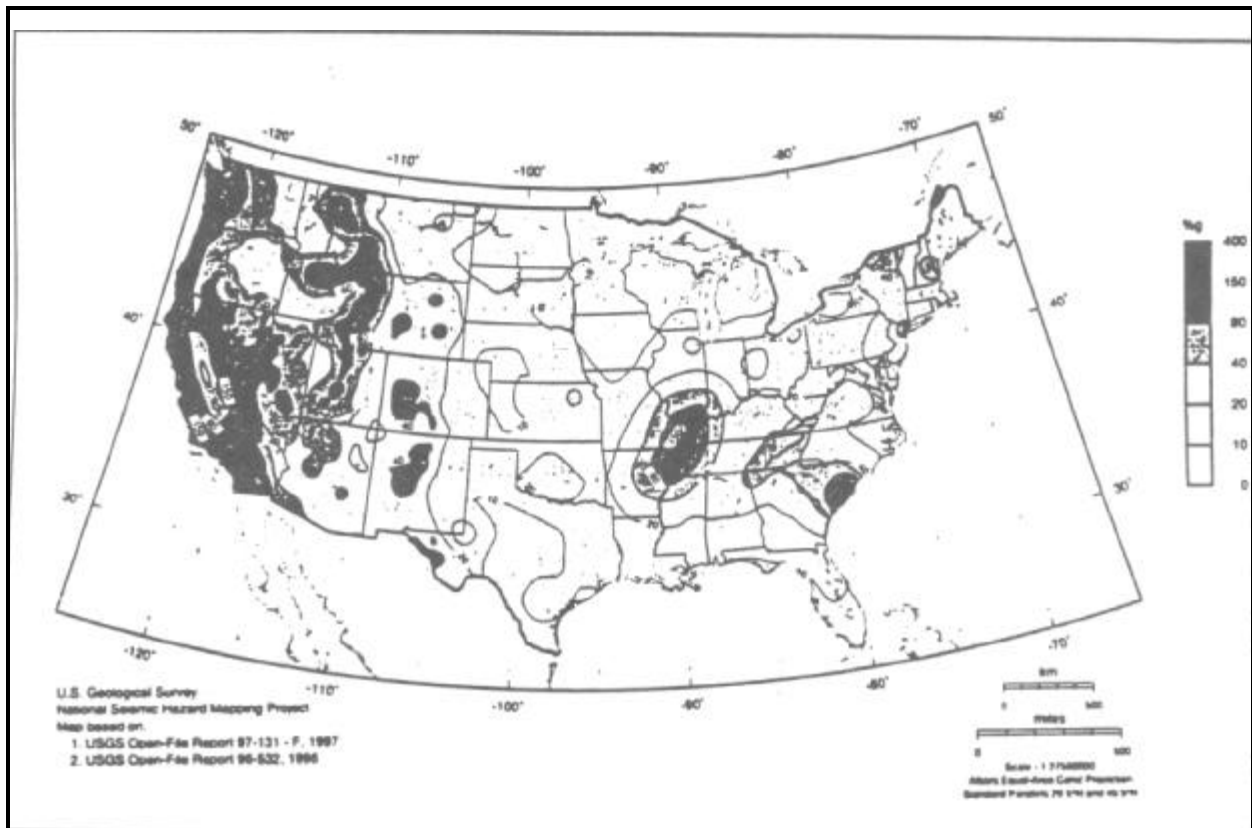

**FIGURE B12 Probabilistic map of 0.2 sec spectral response acceleration with a 2% probability of exceedance in 50 years. The reference site material has a shear wave velocity of 750m/sec.**

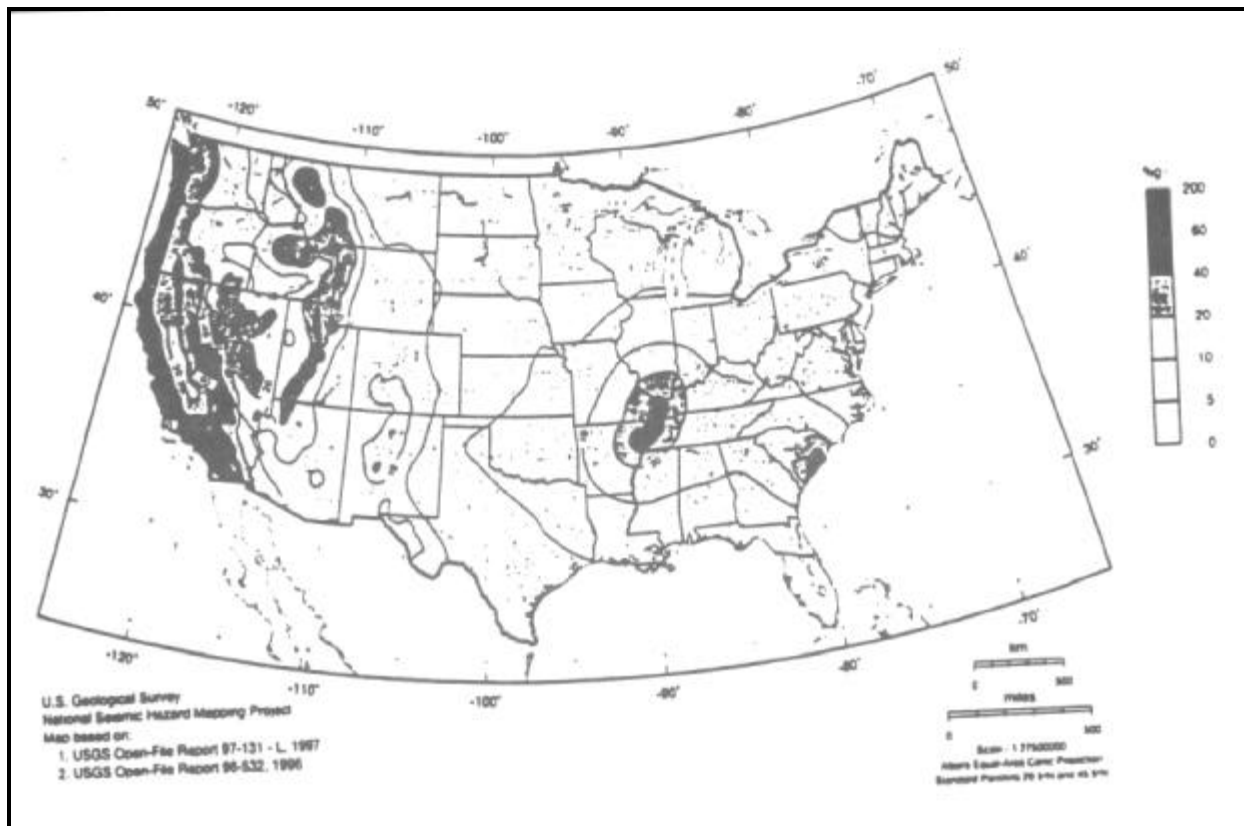

**FIGURE B13 Probabilistic map of 1.0 sec spectral response acceleration with a 2% probability of exceedance in 50 years. The reference site material has a shear wave velocity of 750m/sec.**

## DEVELOPMENT OF NEHRP MAXIMUM CONSIDERED EARTHQUAKE SPECTRAL ACCELERATION MAPS

The *maximum considered earthquake* spectral acceleration maps were derived from the 2 percent in 50 year probabilistic maps shown simplified as Figures 12 and 13 (also see Frankel, et al, 1997), discussed above, with the application of the SDPG rules also described previously. Additional detail in applying the rules is described in this section. The 0.2 sec map is used for illustration purposes. The same procedures and similar comments apply for the 1.0 sec map.

One of the essential features of the SDPG rules was that the recommendations, when applied by others, would result in the same maps. This procedure allows the use of engineering judgement to be used in developing the maps, as long as those judgements are explicitly stated. This approach will simplify modification of the recommendations as knowledge improves.

It should be noted that although the maps are termed *maximum considered earthquake* Ground Motion maps. These maps are not for a single earthquake. The maps include probabilistic effects which consider all possible earthquakes up to the plateau level. Above the plateau level, the contours are included for the deterministic earthquake on each fault (unless the deterministic value is higher than the probabilistic values).

### Deterministic Contours

The deterministic contours, when included, are computed using the same attenuation functions used in the probabilistic analysis. However, the deterministic values are not used unless they are less than the probabilistic values. After study of those areas where the plateau was reached, the only areas where the deterministic values were less than the probabilistic values were located in California and along the subduction zone region of Washington and Oregon. Further study indicated that those areas with values in excess of the plateau were located in California. The appropriate attenuation for this area were the Boore-Joyner-Fumal attenuation (1993,1994) and the Sadigh et al (1993) attenuation.

The form of these attenuations and the distance measures used have an effect on the shape of these deterministic contours. Accordingly, they are discussed below. The Boore-Joyner-Fumal equation is:

$$\log Y = b_{SS} G_{SS} + b_{RS} G_{RS} + b_2(M - 6) + b_4 r + b_5 \log(r) + b_v(\log V_s + \log V_a)$$

where:

- $Y$  = ground motion parameter
- $M$  = earthquake magnitude
- $b_{SS}, b_{RS}$  = coefficients for strike-slip and reverse-slip faults, determined by regression and different for each ground motion parameter
- $G_{SS}$  = 1.0 for strike-slip fault, otherwise zero
- $G_{RS}$  = 1.0 for reverse-slip fault, otherwise zero
- $b_2, b_3, b_4, b_5$  = coefficients determined by regression, different for each spectral acceleration
- $b_v$  = coefficient determined by regression, different for each spectral acceleration
- $V_A$  = coefficient determined by regression, different for each spectral acceleration
- $V_S$  = shear wave velocity for different site category
- $r$  =  $(d^2 + h^2)^{1/2}$
- $d$  = closest horizontal distance from the site of interest to the surface projection of the rupture surface, see Figure B14
- $h$  = fictitious depth determined by regression, different for each ground motion parameter

Coefficients determined by regression are tabulated in the reports describing the attenuation equation.

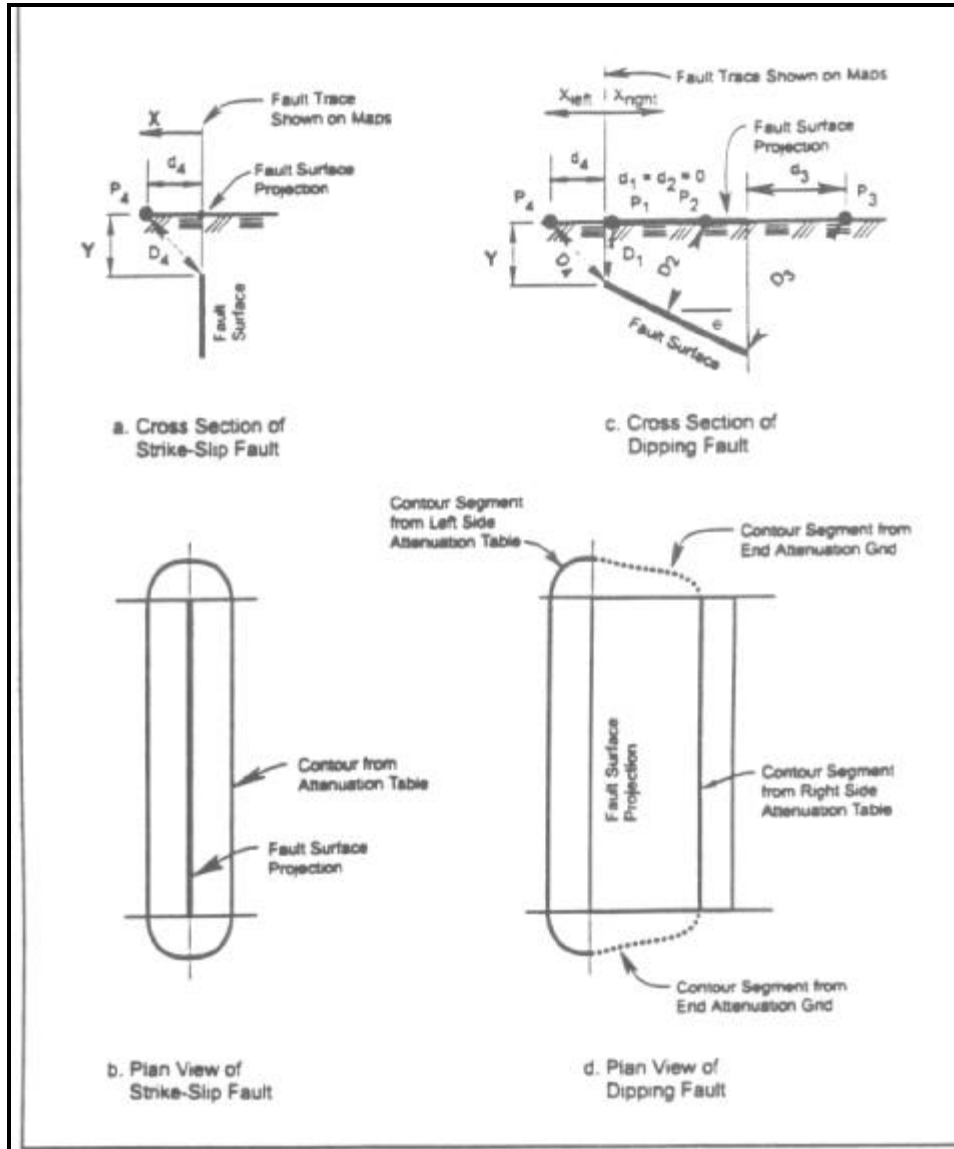

**FIGURE B14** Measures of distance for strike-slip and dipping faults. A cross section of strike-slip fault is shown in figure (a) and the shape of a typical deterministic contour is shown in figure (b). A dipping fault is shown in figure (c) and the shape of a typical deterministic contour is shown in figure (d).

The Sadigh et al. equation is:

$$\ln Y(T) = F(C_1 + C_2 M + C_3(8 - M)^{2.5} + C_4 \ln[D + \exp(C_5 + C_6 M)] + C_7 \ln(D + 2))$$

where:

$Y$  = spectral response acceleration at period  $T$

$M$  = earthquake magnitude

- $C_1, C_2, C_3, \dots, C_7$  = coefficients determined by regression, different for each ground motion parameter
- $D$  = closest distance to the fault rupture surface, see Figure B14
- $F$  = Factor for fault type. 1.0 for strike-slip faults, 1.2 for reverse/thrust faulting, 1.09 for oblique faults

The distance measures are shown in Figure B14 and are discussed in more detail below.

The computation of spectral response (or any ground motion parameter) is a relatively simple matter for a specific site (or specific distance from a fault) but can become complex when preparing contours since it is difficult to calculate the specific distance at which a particular ground motion occurs. This is due to the complexity of the two attenuation functions and the need to combine their results. Since the attenuation functions were weighted equally, each contributes equally to the ground motion at a site. Deterministic contours were determined by preparing attenuation tables, that is the spectral response was computed at various distances from the fault or the fault ends for each earthquake magnitude. Contours for specific values were then drawn by selecting the table for the appropriate magnitude and determining, using interpolation, the distance from the fault for a given spectral acceleration. This procedure required, as a minimum, one attenuation table for each fault. Depending on the fault geometry, more than one table was needed. In order to illustrate this the strike-slip fault is discussed first, followed by a discussion of dipping faults.

*Strike-Slip Faults:* The strike-slip fault, shown in Figure B14a, b is the simplest introduction to application of the SDPG rules. The distance measures are shown for each attenuation function in Figure B14a. The Boore-Joyner-Fumal equation uses the distance,  $d_4$ . The term  $r$  in equation includes  $d_4$  and the fictitious depth  $h$ . Since  $h$  is not zero,  $r > d_4$ , even if the term  $y$  in Figure B14a is zero. The Sadigh et al. equation measures the distance,  $D$ , as the closest distance to the rupture surface. In this case to the top of the rupture. If the depth  $y$  is zero, then  $d_4 = D_4$ .

It makes little difference in the computations if the fault rupture plane begins at the surface or at some distance below the surface. For the strike-slip fault the contour for a particular spectral acceleration is a constant distant from the fault and the contour is as shown in Figure B14b. One attenuation table (including the effects of both attenuation equations) can be used for either side of the fault and at the fault ends.

*Dipping Faults:* The dipping fault, shown in Figures B14c and d, is the most complex case for preparing deterministic contours. The distance measures are shown for each attenuation function in Figure B14c. As before, it is a simple matter to compute the spectral values at a specific site, but not as simple to compute the distance at which a specific spectral acceleration occurs. This is particularly true at the end of the fault.

On the left side of the fault shown in Figure B14c, an attenuation table is prepared, much as in the case of the strike-slip fault. This table may also be used to determine the contour around a portion of the fault end as shown in Figure B14d. In this case it is simply one-quarter of a circle.

A separate attenuation table must be prepared for the right side of the fault as shown in Figure B14d. Since  $d$  or  $D$  is measured differently, depending on location  $x$ , calculations must keep track

of whether or not the location is inside or outside of the surface fault projection. Note that the term  $d$  is zero when the location  $x$  falls within the surface projection, but the fictitious depth  $h$  is not. Outside the fault projection, the distance  $d$  is measured from the edge of the projection. The distance  $D$  is calculated differently, as illustrated in Figure B14c, depending on location but it is always the closest distance to the fault rupture surface.

At the ends of the fault, an attenuation grid was prepared to determine the contour shape shown dotted in Figure B14d. The contour in this area was digitized using the gridded values and combined with the remainder of the contour determined from the left and right attenuation tables. This need for digitizing a portion of the contour greatly increased the time required to prepare each of the contours for dipping faults. In short, each dipping fault required two attenuation tables and an attenuation grid to prepare each deterministic contour. Thus preparation of each contour is far more time-consuming than preparing a contour for a strike-slip fault. Each contour is unsymmetrical around the fault, the amount of asymmetry depends on the angle of dip.

It can be argued that the knowledge of fault locations and geometry does not warrant this level of effort. However, it was considered necessary in order to follow the concept of repeatability in preparing the maps.

*Combining Deterministic Contours:* Where two or more faults are nearby, as in Figure B15a, the deterministic contours were merged (depending on amplitudes) as shown in Figure B15b. The

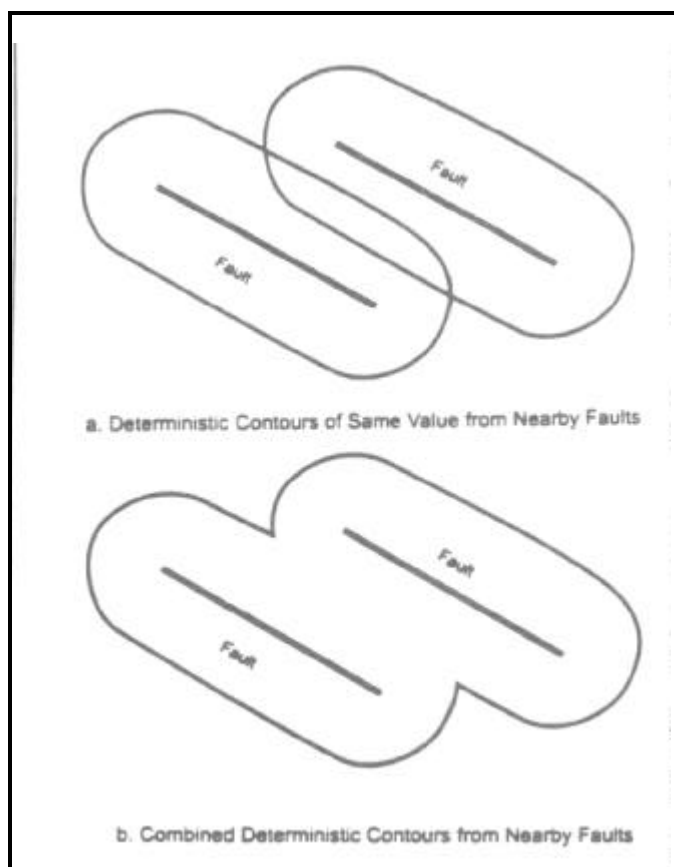

merging resulted in the sharp “corners” shown in the figure. Although it can be argued that these intersections should be smoothed, it was believed that maintaining the shape reflected the decision to use deterministic contours.

#### **Combining Deterministic and Probabilistic Contours**

The SDPG decision to use a combination of deterministic and probabilistic contours, although simple in principle, led to number of problems in preparing the contour maps.

Figure B16a, b for a single strike-slip fault illustrates the concept originally envisioned for combining the deterministic and probabilistic contours. After combining the two sets of contours shown

**FIGURE B15** Procedure for combining deterministic contours from nearby faults.

in Figure B16a, the *maximum considered earthquake* contours would be as shown in Figure B16b.

In application the situation is more complex, there is frequently more than one fault, with different magnitudes, different return times, different fault geometry, and different locations with respect to each other. Examples are shown in Figures 17 and 18 which will be discussed later. The effect of the variables is illustrated in Figure B16 c and d. The deterministic curve is shown for a single fault with a return time much larger than that of the map. The deterministic spectral acceleration is much larger than the spectral acceleration resulting from historical seismicity. The probabilistic curve is not necessarily symmetrical to the fault. The resulting *maximum considered earthquake* curve shown in Figure B16d is a complex mix of the probabilistic and deterministic curves. There is not always a plateau and the curve is not necessarily symmetrical to the fault, even for a strike-slip fault. Simply stated, the probabilistic curve consider other sources such as historical seismicity and other faults as well as time. The deterministic curve does not consider other sources for this simple example and does not consider time.

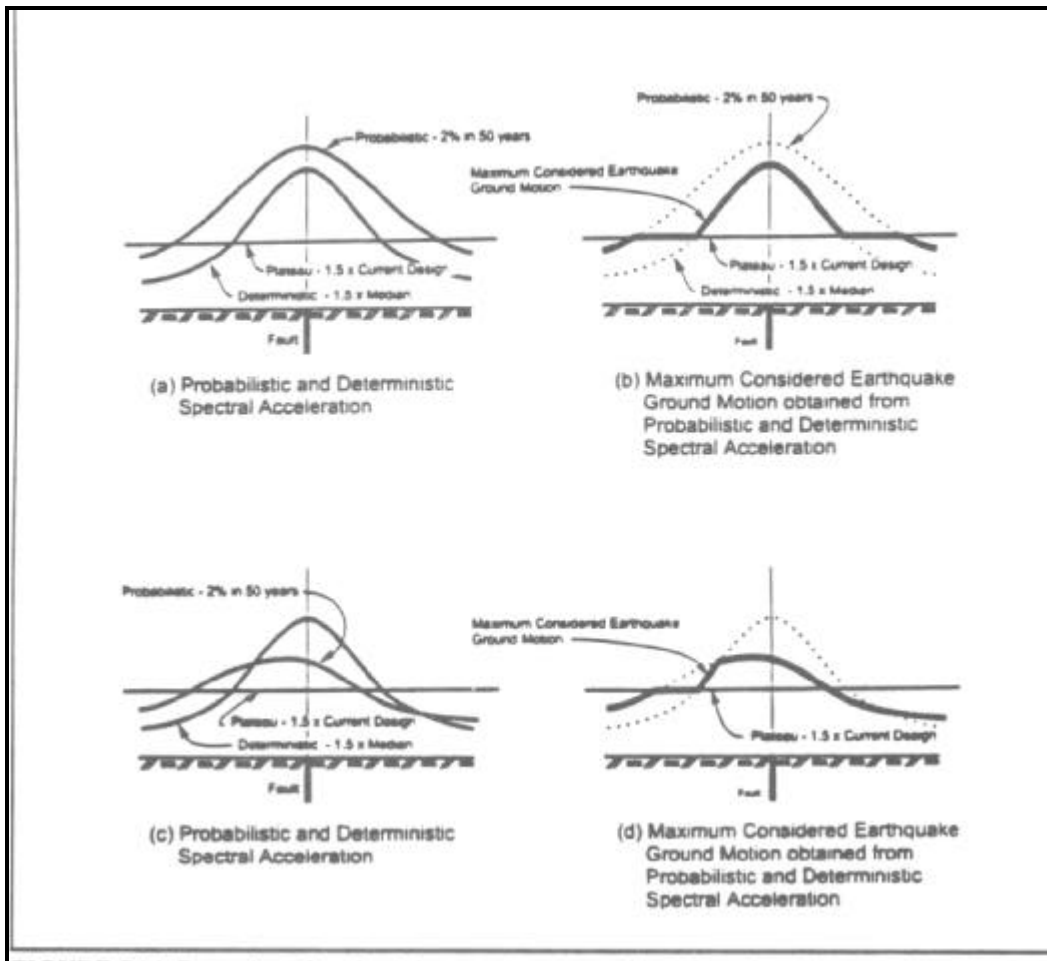

FIGURE B16 Procedure for obtaining maximum considered earthquake ground motion.

The only areas of the United States that have deterministic contours are in California, along the Pacific coast through Oregon and Washington, and in Alaska. At first review it can be seen that there are several other areas that have contours in excess of the plateau but do not have plateaus. In these areas (e.g., New Madrid), the deterministic values exceed the probabilistic ones and thus were not used.

There were several instances where application of the SDPG rules produced results that appear counterintuitive and in other instance produced results that were edited. Two examples from southern California are discussed below. Each example is illustrated with a three-part figure. Part (a) shows both probabilistic contours (dashed) and deterministic contours (solid) for each fault which is also shown. Part (b) shows the *maximum considered earthquake* results produced by following the SDPG rules. Part (c) shows how part (b) was edited for the final map.

*Example 1:* The first example in Figure B17 illustrates the occurrence of gaps in the deterministic contours around a fault and the halt of a deterministic contour before the end of a fault. When the probabilistic contours and deterministic contours shown in Figure B17a are combined, a gap in the deterministic contours occurs in the vicinity of  $34.6^{\circ}$  and  $118.8^{\circ}$ . Similarly the deterministic contours stop prior to the end of the fault around  $34.65^{\circ}$  and  $119.4^{\circ}$ . Both of these are shown in Figure B17b.

After study, it is clear that the SDPG rules results in a repeatable, but unusual, set of contours. The result does not go along with the concept of accounting for near fault effects with the deterministic contours. Because of this undesirable effect, the contours were hand edited to restore the gaps and produce the result in Figure B17c.

All occurrences similar to this were edited to modify the contours so that the deterministic contours did not have abrupt breaks or stops before the ends of the fault.

*Example 2:* The second example in Figure B18 illustrates the occurrence of many faults at different orientations to each other and with different return times. Merging of the complex set of contours is shown in Figure B18b. The contours are greatly simplified. Some small plateaus are shown along the 150 percent contour, as is a gap along one of the faults around  $34.0^{\circ}$  and  $116.35^{\circ}$ . The gap was edited as in example 1. The small plateaus were edited out using the judgement that their presence was inconsequential (less than a few percent effect on the maps) and unnecessarily complicated an already complicated map.



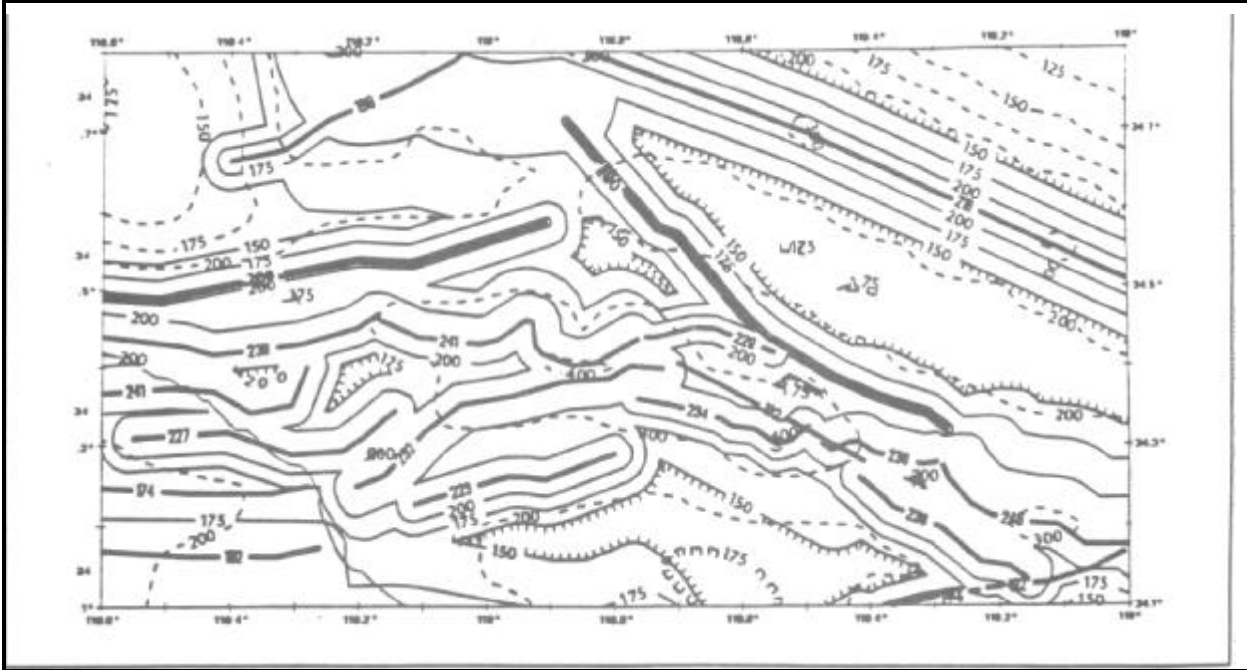

FIGURE B17a Combining contours – Example 1. Both probabilistic and deterministic contours are shown. Probabilistic contours are shown dotted.

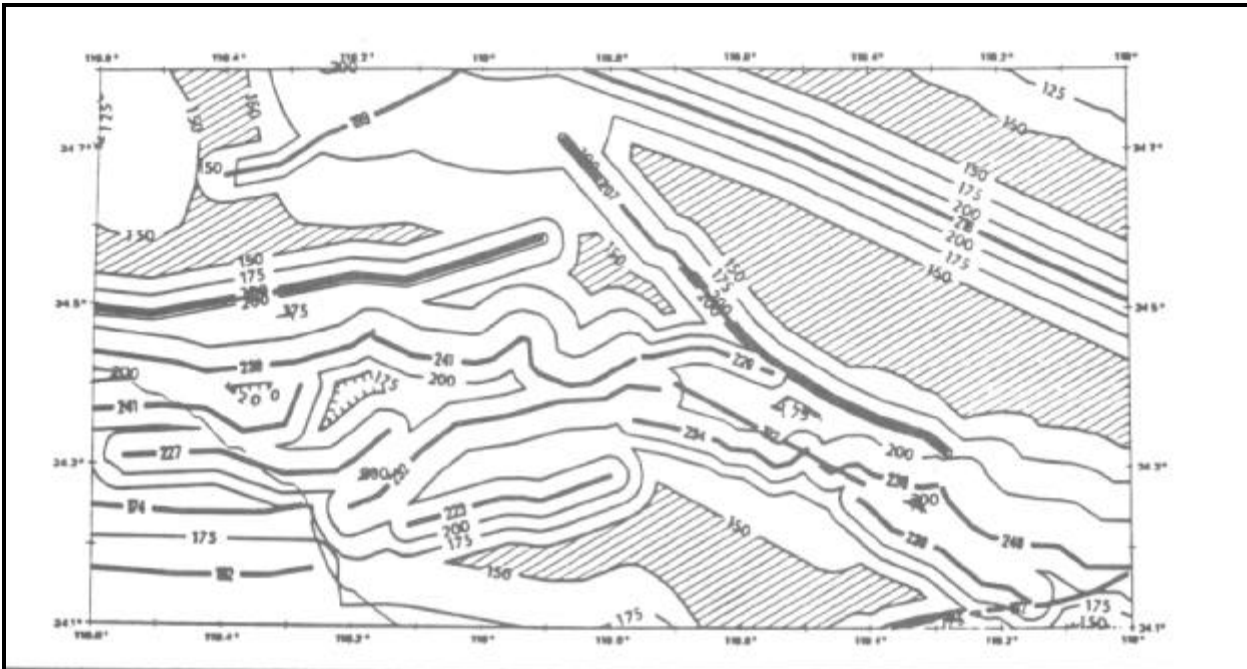

FIGURE B17b Combining contours – Example 1. Both probabilistic contours are merged using strict interpretation of committee rules.

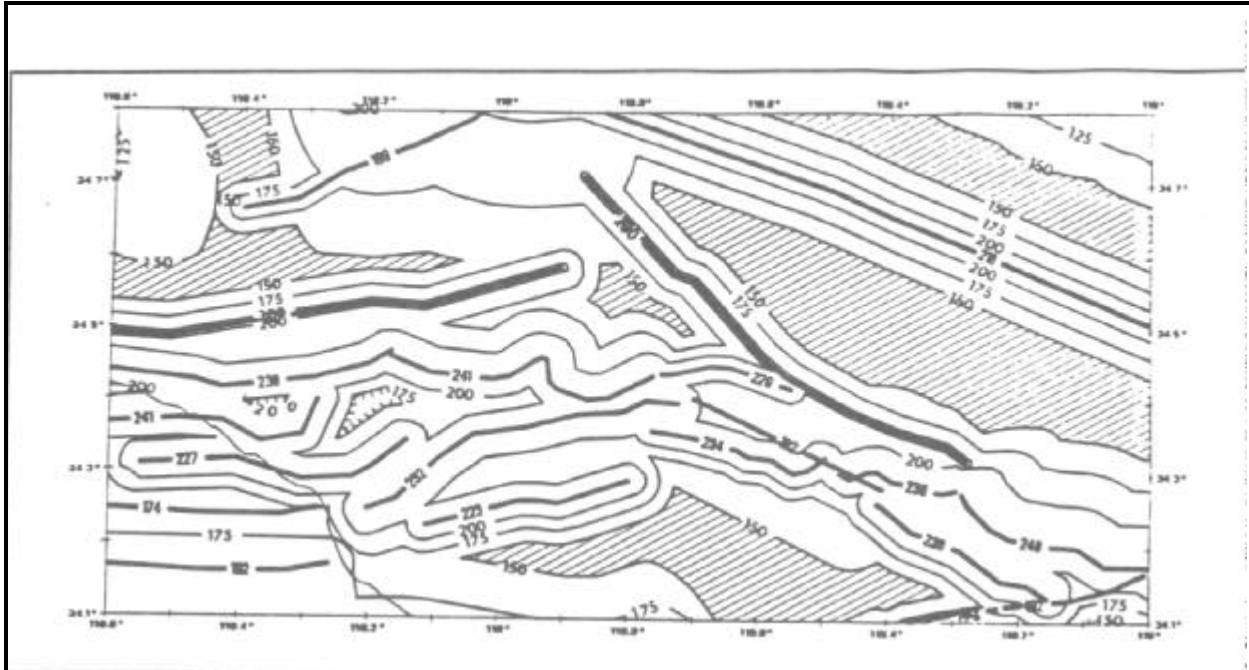

FIGURE B17c Combining contours – Example 1. Probabilistic contours are merged with deterministic contours using strict interpretation of committee rules with subsequent editing.

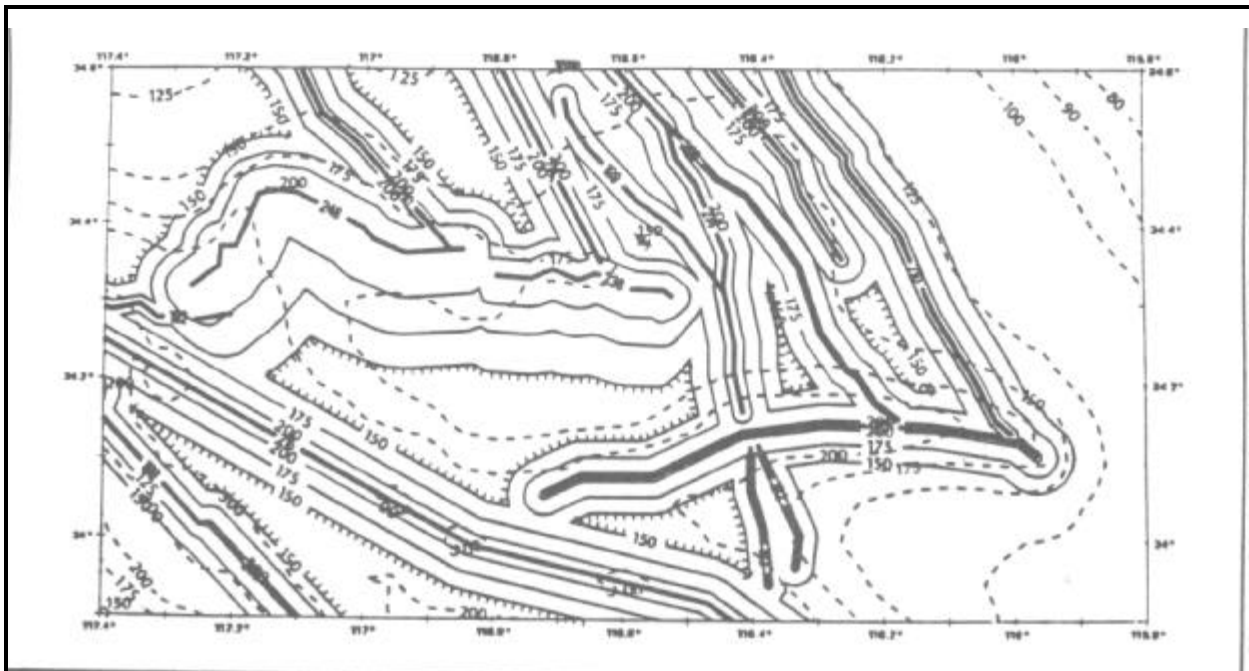

FIGURE B18a Combining contours – Example 1. Both probabilistic and deterministic contours are shown. Probabilistic contours are shown dotted.

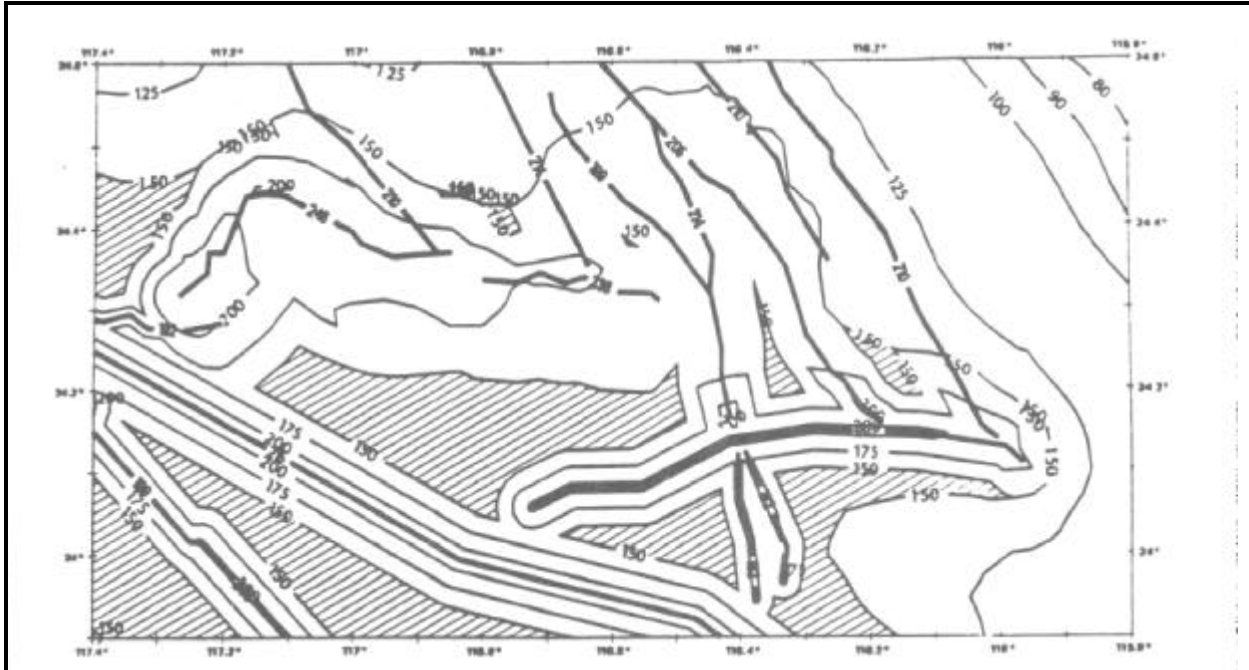

FIGURE B18b Combining contours – Example 1. Probabilistic contours are merged using strict interpretation of committee rules.

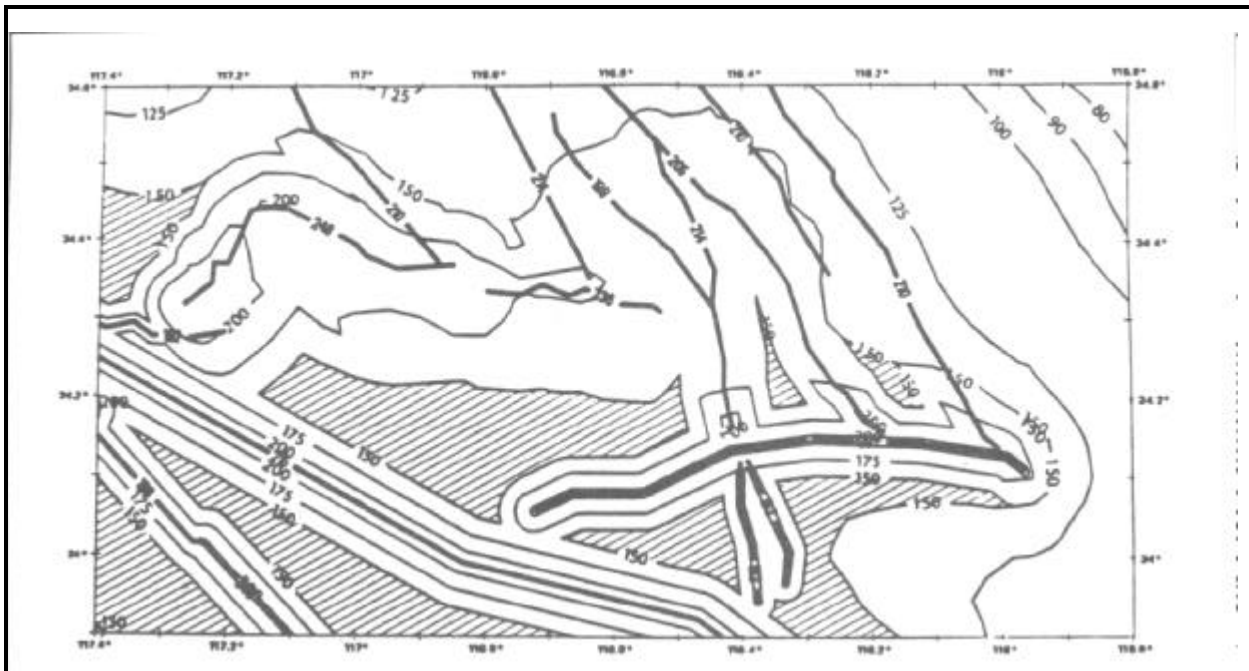

FIGURE B18c Combining contours – Example 1. Probabilistic contours are merged with deterministic contours using strict interpretation of committee rules with subsequent editing.

Another problem created was that some of the faults have portions of the fault, with a specific acceleration value, in areas where the contours are less than the fault value. An example occurs with the fault labeled 248 in the vicinity of  $34.4^\circ$  and  $117.2^\circ$ . A footnote was added to the *maximum considered earthquake* maps to the effect that the fault value was only to be used in areas where it exceeded the surrounding contours. Although other approaches are possible, such as showing the unused portion of the fault dashed, the full length of the faults are shown solid in the maps.

As shown in Figure B18b, a sawtooth contour around  $34.15^\circ$  and  $116.3^\circ$  results from application of committee rules. Although this appears to be a candidate for smoothing, it was not done as shown in Figure B18c. Once again there are several possible ways to smooth but it was not done in the interest of repeatability.

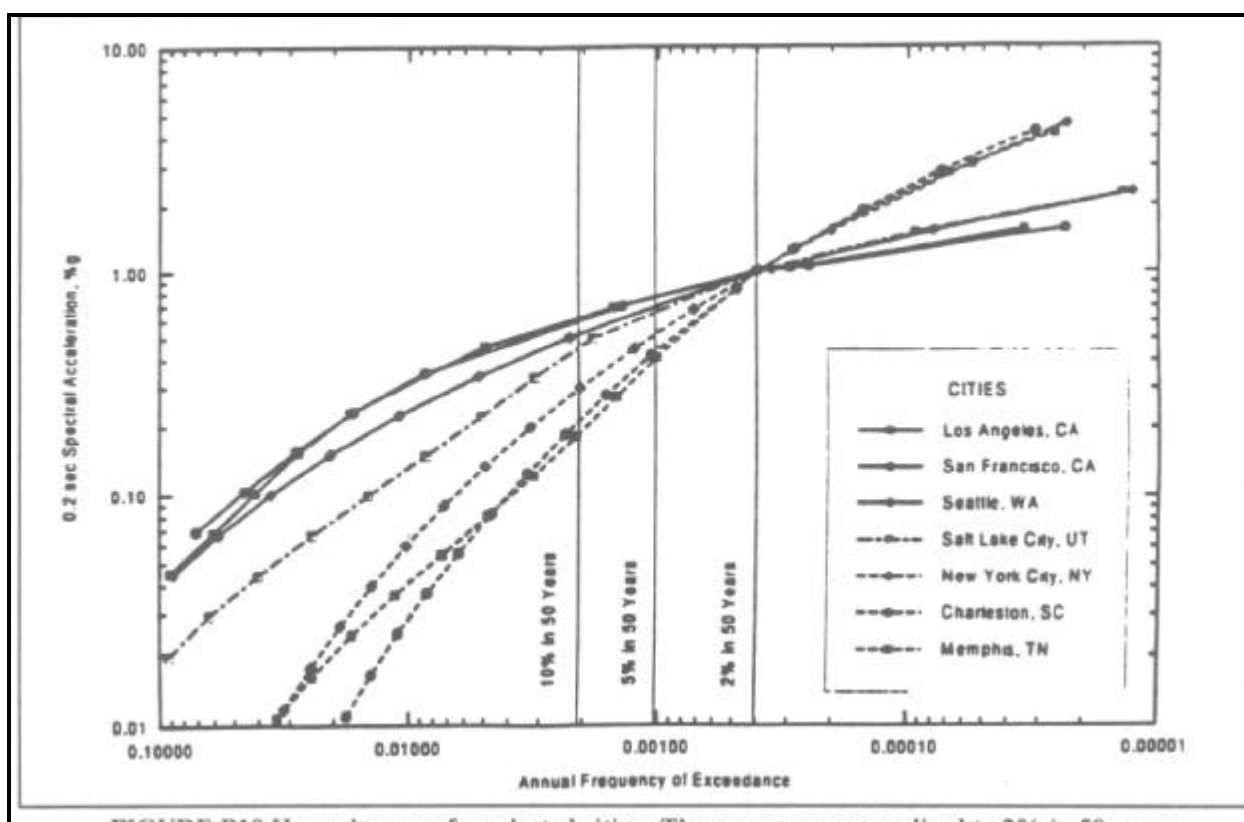

FIGURE B19 Hazard curves for selected cities. The curves are normalized to 2% in 50 years.

### Probability Level

The maximum considered earthquake spectral acceleration maps use the 2 percent in 50 maps as a base; however, the values obtained from the maps are multiplied by  $2/3$  for use in the design equation. This implicitly results in a different probability being used in different areas of the United States. The hazard curves shown in Figure B2 are normalized to the 2 percent in 50 year value in Figure B19. This figure shows that the slope of the hazard curve varies in different areas of the United States. In general, the curves are steeper for CEUS cities than for WUS cities with

the WUS curves beginning to flatten out earlier than the CEUS cities. Typical curves for a CEUS and WUS city are shown in Figure B20. This figure shows that when the 2/3 factor is applied, probabilistic values for WUS location are close to a 10 percent in 50 year value and probabilities for CEUS locations reflect a lower probability.

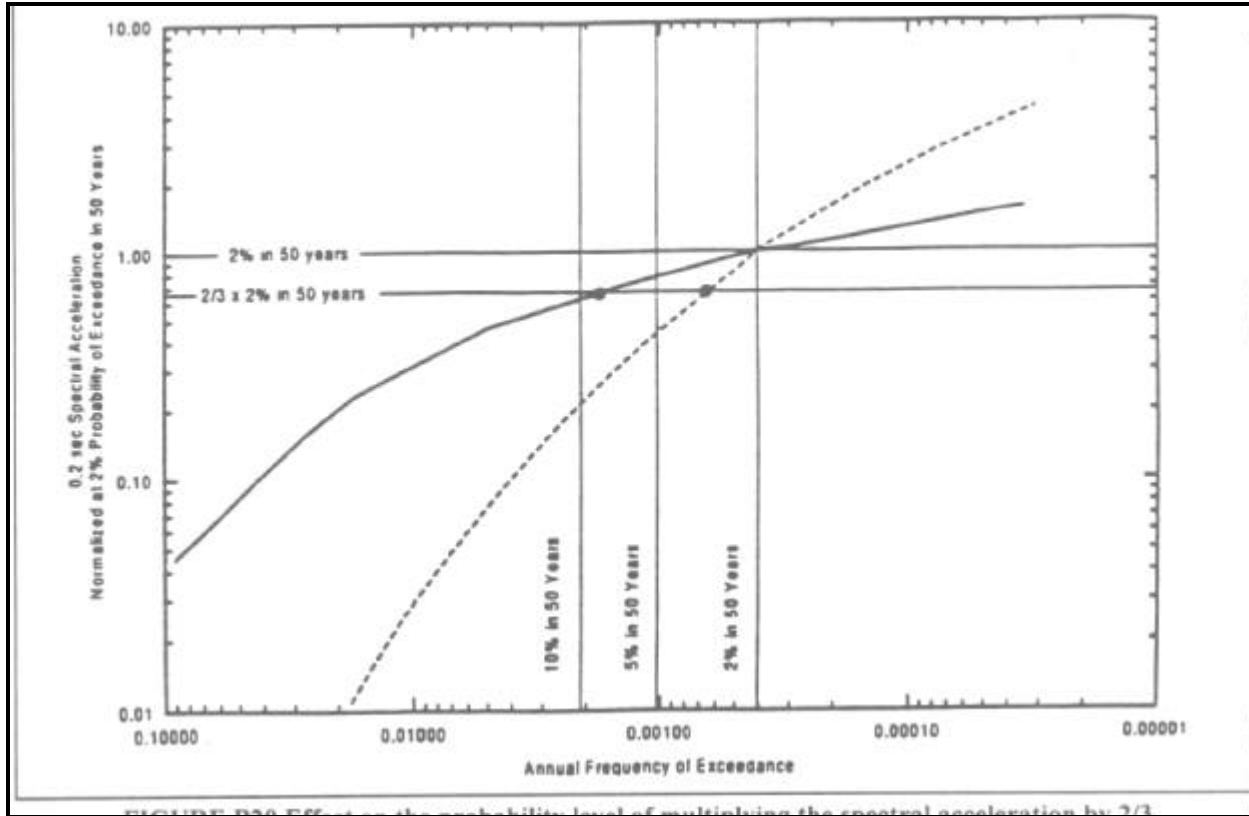

FIGURE B20 Effect on the probability level of multiplying the spectral acceleration by 2/3.

### Interpolation

Linear interpolation between contours is permitted using the *maximum considered earthquake* maps. To facilitate interpolation, spot values have been provided inside closed contours of increasing or decreasing values of the design parameter. Additional spot values have been provided where linear interpolation would be difficult. Values have also been provided along faults in the deterministic areas to aid in interpolation.

### Hawaii

The Hawaii State Earthquake Advisory Board (HSEAB), in its ballot on the 1997 *Provisions*, proposed different maps from those included in the original BSSC ballot. The HSEAB's comments were based in part on recent work done to propose changes in seismic zonation for the 1994 and 1997 *Uniform Building Code*. The HSEAB also was concerned that in early 1998 the USGS would be completing maps that would be more up to date than those included in the original BSSC ballot. Essentially, the HSEAB's recommendation was that the maps it submitted or

the new USGS maps should be used for Hawaii. The USGS maps were completed in March 1998 and were reviewed by the HSEAB, including proposals for incorporation of deterministic contours where the ground motions exceed the plateau levels described previously. The maps were revised in response to review comments and the modified design maps are included as part of the *Provisions*.

Briefly, the probabilistic maps were prepared using a USGS methodology similar to that used for the western United States. Two attenuation functions were used: Sadigh as described earlier and Munson and Thurber, which incorporates Hawaii data. The Hawaii contour maps (*Provisions* Maps 19 and 20) are probabilistic except for two areas on the island of Hawaii. The two areas (outlined by the heavy border on Maps 19 and 20) are located on the western and southeastern portion of the island. The two areas are defined by horizontal rupture planes at a 9 km depth. Within these zones, the spectral accelerations are constant. The western zone uses a magnitude 7.0 event while the southwestern zones uses a magnitude 8.2 event. The deterministic values inside the zone and for the contours were calculated as described in earlier sections.

Documentation for the maps is being prepared. The probabilistic maps and documentation are available on the USGS internet site (<http://geohazards.cr.usgs.gov/eq/>)

#### **Additional Maximum Considered Earthquake Ground Motion Maps**

Although new probabilistic maps were not available for Puerto Rico, Culebra, Vieques, St. Thomas, St. John, St. Croix, Guam, and Tutuila *maximum considered earthquake* maps were required for use by the *Provisions*. *Maximum considered earthquake* spectral response maps for these areas were prepared as follows.

Maps for Puerto Rico, Culebra, Vieques, St. Thomas, St. John, St. Croix, Guam, and Tutuila, were prepared using the 1994 NEHRP maps. These were for approximately 10 percent probability of exceedance in 50 years. The ratio of PGA for 2 percent in 50 years to 10 percent in 50 years for the new USGS maps is about two. Accordingly maps for these areas were converted to 2 percent in 50 year maps by multiplying by two. These maps were then converted to spectral maps by using the factors described below.

A study of the ratios of the 0.2 sec and 1.0 sec spectral responses to PGA was done. Although approximate, the ratios were about 2.25 to 2.5 for the 0.2 sec spectral acceleration and about 1.0 for the 1.0 sec response. Thus PGA for the above regions was converted to spectral acceleration by multiplying PGA by 2.5 for the 0.2 sec response and by 1.0 for the 1.0 sec response. It should be noted that the multiplier for the 1.0 sec response varied over a wider range than the 0.2 sec response multiplier. It should be used cautiously.

#### **REFERENCES**

Adams, J., D.H. Weichert, S. Halchuk, and P.W. Basham. 1996. Trial seismic hazard maps of Canada-1995: final values for selected Canadian cities, Geological Survey of Canada, Open File 3283.

Algermissen, S.T., D.M. Perkins, P.C. Thenhaus, S.L. Hanson, and B.L. Bender. 1990. *Probabilistic Earthquake Acceleration and Velocity Maps for the United States and Puerto Rico*, U.S. Geological Survey, Miscellaneous Field Studies Map MF-2120.

- Algermissen, S.T., E.V. Leyendecker, G.A. Bollinger, N.C. Donovan, J.E. Ebel, W.B. Joyner, R.W. Luft, and J.P. Singh. 1991. "Probabilistic Ground-motion Hazard Maps of Response Spectral Ordinates for the United States," in *Proceedings of Fourth International Conference on Seismic Ordinates for the United States*, Stanford Univ., v. II, pp. 687-694.
- Amick, D. and R. Gelinas. 1991. "The Search for Evidence of Large Prehistoric Earthquakes along the Atlantic Seaboard," *Science*, v. 251, pp. 655-658.
- Atwater, B.F. and E. Hemphill-Haley . 1996. Preliminary estimates of recurrence intervals for great earthquakes of the past 3500 years at northeastern Willapa Bay, Washington, U.S. Geological Survey, Open-file report 96-001, 88pp.
- Atwater, B., A. Nelson, J. Clague, G. Carver, D. Yamaguchi, P. Bobrowsky, J. Bourgeois, M. Darienzo, W. Grant, S. Palmer, C. Peterson, and M. Reinhart . 1995. Summary of coastal geologic evidence for past great earthquakes at the Cascadia subduction zone, *Earthquake Spectra*, v. 11, pp. 1-18.
- Black, B.D., W.R. Lund, and B.H. Mayes . 1995. Large earthquakes on the Salt Lake City segment of the Wasatch Fault Zone--summary of new information from the South Fork Dry Creek site, Salt Lake County, Utah, in *Environmental and Engineering Geology of the Wasatch Front Region*, W.R. Lund . ed., Utah Geological Association Publication 24, 1995.
- Boore, D.M., W.B. Joyner, and T.E. Fumal . 1993. Estimation of response spectra and peak accelerations from western North American earthquakes: an interim report, U.S. Geological Survey open-file report 93-509.
- Boore, D.M., W.B. Joyner, and T.E. Fumal . 1994a. Estimation of response spectra and peak accelerations from western North American earthquakes: an interim report Part 2, U.S. Geological Survey open-file report 94-127.
- Boore, D.M., W.B. Joyner and T.E. Fumal. 1994b. Ground motion estimates for strike- and reverse-slip faults . pre-print.
- Boore, D.M., W.B. Joyner, and T.E. Fumal . 1997. Equations for estimating horizontal response spectra and peak acceleration from western North American earthquakes: a summary of recent work, *Seismological Research Letters*, v.68, no. 1, pp. 128-153.
- Chandler, V.W. 1995. The west-central Minnesota earthquake of June 5, 1993: an opportunity to re-examine seismicity near the Morris Fault, *Seism. Res. Letts*, v. 66, no. 6, pp. 113-121.
- Crone, A.J. and K.V. Luza. 1990. "Style and Timing of Holocene Surface Faulting on the Meers Fault, Southwestern Oklahoma," *Geological Societ of America Bulletin*, v. 102, pp. 1-17.
- Crone, A., M. Machette, L. Bradley and S. Mahan. 1996. *Holocene Surface Faulting on the Cheraw Fault, Southeastern Colorado*, U.S. Geological Survey, MF map, in press.
- Crouse, C.B. 1991. Ground-motion attenuation equations for earthquakes on the Cascadia subduction zone, *Earthquake Spectra*, v. 7, pp. 201-.

- Doser, D.I. 1985. Source parameters and faulting processes of the 1959 Hebgen Lake, Montana, earthquake sequence, *J. Geophys. Res.*, v. 90, pp. 4537-4556.
- Electric Power Research Institute. 1986. Seismic hazard methodology for the central and eastern United States, 10 volumes, EPRI report NP-4726, Electric Power Research Institute, Palo Alto.
- Edge, K.M., B.A. Scheol, and I. Po Lam. 1992. Development of seismic maps for Arizona, Arizona Dept. of Transportation, report no. FHWA-AZ92-344.
- Frankel, A. 1995. "Mapping seismic hazard in the Central and Eastern United States", *Seismological Research Letters*, v.,66, no. 4, pp. 8-21.
- Frankel A., C. Mueller, T. Barnhard, D. Perkins, E. Leyendecker, N. Dickman, S. Hanson, and M. Hopper. 1996. *National Seismic Hazard Maps, June 1996: Documentation*, U.S. Geological Survey, Open-file Report 96-532.
- Frankel A., C. Mueller, T. Barnhard, D. Perkins, E. Leyendecker, N. Dickman, S. Hanson, and M. Hopper. 1997a. *Seismic - Hazard Maps for the Conterminous United States*: U.S. Geological Survey, Open-file Report 97-130, 12 sheets, scale 1:7,000,000.
- Frankel A., C. Mueller, T. Barnhard, D. Perkins, E. Leyendecker, N. Dickman, S. Hanson, and M. Hopper. 1997b. *Seismic - Hazard Maps for the California, Nevada and Western Arizona/Utah*: U.S. Geological Survey, Open-file Report 97-130, 12 sheets, scale 1:2,000,000.
- Geomatrix Consultants. 1993. Seismic margin earthquake for the Trojan site: final unpublished report prepared for Portland General Electric Trojan Nuclear Plant, Ranier, Oregon. Note: tables of these attenuation relationships are included in Geomatrix . 1995.
- Geomatrix Consultants. 1995. Seismic design mapping state of Oregon, Final Report prepared for Oregon Department of Transportation, Salem, Oregon.
- Goldfinger, C., L.D. Kulm. R.S. Yeats, B. Applegate, M. MacKay, and G.R. Cochrane . in press. Active strike-slip faulting and folding of the Cascadia plate boundary and forearc in central and northern Oregon, in Rogers, A.M., W.J. Kockelman, G. Priest, and T.J. Walsh . eds., *Assessing and reducing earthquake hazards in the Pacific northwest*, U.S. Geological Survey Professional Paper 1560.
- Hyndman, R.D. and K. Wang. 1995. The rupture zone of Cascadia great earthquakes from current deformation and the thermal regime, *J. Geophys. Res.*, v. 100, pp. 22,133-22,154.
- Johnston, A. 1994. Moment magnitude assessment of stable continental earthquakes, Part I: instrumental seismicity, pre-print . published with revised relations in *Geophys. J. Int.*, [1996], v. 124, pp. 381-414
- Johnston, A. 1996a. "Moment Magnitude Assessment of Stable Continental Earthquakes, Part 2: Historical Seismicity," *Geophys. J. Int.*, v. 125, pp. 639-678.
- Johnston, A. 1996b. "Seismic Moment Assessment of Stable Continental Earthquakes, Part 3: 1811-1812 New Madrid, 1886 Charleston, and 1755 Lisbon," submitted to *Geophys. J. Int.*



- Johnston, A.C., K.J. Coppersmith, L.R. Kanter, and C.A. Cornell. 1994. The earthquakes of stable continental regions: assessment of large earthquake potential, EPRI TR-102261, J.F. Schneider, ed., Electric Power Research Institute, 309 pp.
- Johnston, A.C. and E.S. Schweig . 1996. The enigma of the New Madrid earthquakes of 1811-1812, *Annual Review of Earth and Planetary Sciences*, v. 24, pp. 339-384.
- Joyner, W.B. 1995. Advocacy Paper #4, Soil is the most appropriate reference site condition, in ATC 35-2, Preprints: National Earthquake Ground Motion Mapping Workshop, Applied Technology Council.
- Leyendecker, E.V., D.M. Perkins, S.T. Algermissen, P.C. Thenhaus, and S.L. Hanson. 1995. *USGS Spectral Response Maps and Their Relationship with Seismic Design Forces in Building Codes*, U.S. Geological Survey, Open-File Report 95-596.
- Lienkaemper, J.J. 1996. "Fault parameter compilation for northern California", in preparation.
- Martin, G.R. and R. Dobry. 1994. Earthquake site response and seismic code provisions, *NCEER Bulletin*, v. 8, pp. 1-6.
- Mueller, C., M. Hopper, and A. Frankel. 1996. Preparation of earthquake catalogs for the 1996 national seismic hazard maps: documentation, U.S. Geological Survey Open-File Report, in review.
- Mueller, C., M. A. Frankel, J. Lahr, and M. Wyss.. 1997. Preparation of earthquake catalogs for the National Seismic Hazard Maps: Alaska, U.S. Geological Survey Open-File Report, in review.
- Obermeier, S.F., R.B. Jacobson, J.P. Smoote, R.E. Weems, G.S. Gohn. J.E. Monroe, and D.S. Powers. 1990. "Earthquake-induced Liquefaction Features in the Coastal Setting of South Carolina and in the Fluvial Setting of the New Madrid Seismic Zone," *U.S. Geological Survey, Prof. Paper 1504*, 44 pp.
- Obermeier, S.F., P.J. Munson, C.A. Munson, J.R. Martin, A.D. Frankel, T.L. Youd, and E.C. Pond. 1992. "Liquefaction Evidence for Strong Holocene Earthquake. s in the Wabash Valley of Indiana-Illinois", *Seismological Research Letters*, v. 63, pp. 321-336.
- Petersen, M.D. and S.G. Wesnousky. 1994. Fault slip rates and earthquake histories for active faults in southern California, *Bull. Seism. Soc. Am.*, v. 84, pp. 1608-1649.
- Petersen, M.D., C.H. Cramer, W.A. Bryant, M.S. Reichle, and T.R. Toppozada. 1996. Preliminary hazard assessment for Los Angeles, Ventura, and Orange counties, California, affected by the 17 January 1994 Northridge earthquake, *Bull. Seism. Soc. Am.*, v. 86, pp. S247-S261.
- Powell, C., G. Bollinger, M. Chapman, M. Sibol, A. Johnston, and R. Wheeler. 994. A seismotectonic model for the 300-kilometer-long eastern Tennessee seismic zone, *Science*, v. 264, pp. 686-688.
- Sadigh, K., C.Y. Chang, N.A. Abrahamson, S.J. Chiou, and M.S. Power . 1993. Specification of long-period ground motions: updated attenuation relationships for rock site conditions and adjustment factors for near-fault effects, in *Proceedings of ATC-17-1 Seminar on Seismic Isola-*

- tion, Passive Energy Dissipation, and Active Control, Applied Technology Council, Redwood City. Note: tables of these attenuation relationships are included in Geomatrix . 1995.
- Sadigh, K., C.Y. Chang, J. Egan, F. Makdisi, and R. Youngs. 1997. Attenuation relationships for shallow crustal earthquakes based on California strong motion data, *Seismological Research Letters*, v.68, no. 1, pp. 180-189.
- Satake, K., K. Shimazaki, Y. Tsuji, and K. Ueda. 1996. Time and size of a giant earthquake in Cascadia inferred from Japanese tsunami record of January 1700, *Nature*, v. 379, pp. 246-249.
- Schwartz, D.P. and K.J. Coppersmith. 1984. Fault behavior and characteristic earthquakes: examples from the Wasatch and San Andreas fault zones, *J. Geophys. Res.*, v. 89, pp. 5681-5698.
- Seeber, L. and J. G. Armbruster. 1991. *The NCEER-91 Earthquake Catalog: Improved Intensity-based Magnitudes and Recurrence Relations for U.S. Earthquakes East of New Madrid*, National Center for Earthquake Engineering Research, NCEER-91-0021.
- Senior Seismic Hazard Analysis Committee . 1996?. *Probabilistic Seismic Hazard Analysis: a Consensus Methodology*, supported by DOE, NRC, and EPRI.
- Sibol, M.S., G.A. Bollinger, and J.B. Birch. 1987. "Estimation of Magnitudes in Central and Eastern North America Using Intensity and Felt Area," *Bulletin of the Seismological Society of America*, v. 77, pp. 1635-1654.
- Stover, C.W. and J.L. Coffman. 1993. "Seismicity of the United States 1568-1989 . revised," *U.S. Geological Survey Professional Paper 1527*.
- Stover, C.W., G. Reagor, and S.T. Algermissen. 1984. *United States Earthquake Data File*, U.S. Geological Survey Open-File Report 84-225.
- Toro, G.R., N.A. Abrahamson, and J.F. Schneider. 1993. "Engineering Model of Strong Ground Motions from Earthquakes in the Central and Eastern United States," in *Guidelines for Determining Design Basis Ground Motions*, EPRI TR-102293, J.F. Schneider, ed., Electric Power Research Institute.
- U.S. Geological Survey National Seismic-Hazard Mapping Project, 1998a, *Alaska Seismic-Hazard Maps: Documentation*, U.S. Geological Survey, Open-file Report, in progress.
- U.S. Geological Survey National Seismic-Hazard Mapping Project, 1998b, *Seismic-Hazard Maps of Alaska*: U.S. Geological Survey, Open-file Report, 6 sheets, scale 1:5,000,000, in progress.
- Ward, S.N. 1994. A multidisciplinary approach to seismic hazard in southern California, *Bull. Seism. Soc. Am.*, v.84, pp. 1293-1309.
- Weichert, D.H. 1980. Estimation of earthquake recurrence parameters for unequal observation periods for different magnitudes, *Bull. Seism. Soc. Am.*, 70, pp. 1337-1356.
- Wells, D.L. and K.J. Coppersmith. 1994. "New empirical relationships among magnitude, rupture length, rupture width, and surface displacement," *Bulletin of the Seismological Society of America*, v. 84, pp. 974-1002.

- Wesnousky, S.G. 1986. Earthquakes, Quaternary faults, and seismic hazard in California, *J. Geophys. Res.*, v. 91, pp. 12,587-12,631.
- Wheeler, R.L. 1995. "Earthquakes and the Cratonward Limit of Iapetan Faulting in Eastern North America," *Geology*, v. 23, pp. 105-108.
- Working Group on California Earthquake Probabilities. 1995. Seismic hazards in southern California: probable earthquakes, 1994 to 2024, *Bull. Seism. Soc. Am.*, v. 85, pp. 379-439.
- Wyman, R.V. M. Karakouzian, V. Bax-Valentine, D.B. Slemmons, L. Peterson, and S. Palmer . 1993. Geology of Las Vegas, Nevada, *Bull. Assoc. of Engineer. Geologists*, v. XXX, pp. 33-78.
- Youngs, R., Chiou, W. Silva, and J. Humphrey. 1997. Strong ground motion attenuation relationships for subduction zone earthquakes, *Seismological Research Letters*, v.68, no. 1, pp. 180-189.



Of the National Institute of Building Sciences

## **THE COUNCIL: ITS PURPOSE AND ACTIVITIES**

The Building Seismic Safety Council (BSSC) was established in 1979 under the auspices of the National Institute of Building Sciences as an entirely new type of instrument for dealing with the complex regulatory, technical, social, and economic issues involved in developing and promulgating building earthquake risk mitigation regulatory provisions that are national in scope. By bringing together in the BSSC all of the needed expertise and all relevant public and private interests, it was believed that issues related to the seismic safety of the built environment could be resolved and jurisdictional problems overcome through authoritative guidance and assistance backed by a broad consensus.

The BSSC is an independent, voluntary membership body representing a wide variety of building community interests. Its fundamental purpose is to enhance public safety by providing a national forum that fosters improved seismic safety provisions for use by the building community in the planning, design, construction, regulation, and utilization of buildings. To fulfill its purpose, the BSSC:

- Promotes the development of seismic safety provisions suitable for use throughout the United States;
- Recommends, encourages, and promotes the adoption of appropriate seismic safety provisions in voluntary standards and model codes;
- Assesses progress in the implementation of such provisions by federal, state, and local regulatory and construction agencies;
- Identifies opportunities for improving seismic safety regulations and practices and encourages public and private organizations to effect such improvements;
- Promotes the development of training and educational courses and materials for use by design professionals, builders, building regulatory officials, elected officials, industry representatives, other members of the building community, and the public;
- Advises government bodies on their programs of research, development, and implementation; and
- Periodically reviews and evaluates research findings, practices, and experience and makes recommendations for incorporation into seismic design practices.

The BSSC's area of interest encompasses all building types, structures, and related facilities and includes explicit consideration and assessment of the social, technical, administrative, political, legal, and economic implications of its deliberations and recommendations. The BSSC believes that the achievement of its purpose is a concern shared by all in the public and private sectors; therefore, its activities are structured to provide all interested entities (i.e., government bodies at all levels, voluntary organizations, business, industry, the design profession, the construction industry, the research community, and the general public) with the opportunity to participate. The BSSC also believes that the regional and local differences in the nature and magnitude of potentially hazardous earthquake events require a flexible approach to seismic safety that allows for consideration of the relative risk, resources, and capabilities of each community.

The BSSC is committed to continued technical improvement of seismic design provisions, assessment of advances in engineering knowledge and design experience, and evaluation of earthquake impacts. It recognizes

that appropriate earthquake hazard risk reduction measures and initiatives should be adopted by existing organizations and institutions and incorporated, whenever possible, into their legislation, regulations, practices, rules, codes, relief procedures, and loan requirements so that these measures and initiatives become an integral part of established activities, not additional burdens. Thus, the BSSC itself assumes no standards-making or -promulgating role; rather, it advocates that code- and standards-formulation organizations consider the BSSC's recommendations for inclusion in their documents and standards.

## **IMPROVING THE SEISMIC SAFETY OF NEW BUILDINGS**

The BSSC program directed toward improving the seismic safety of new buildings has been conducted with funding from the Federal Emergency Management Agency (FEMA). It is structured to create and maintain authoritative, technically sound, up-to-date resource documents that can be used by the voluntary standards and model code organizations, the building community, the research community, and the public as the foundation for improved seismic safety design provisions.

The BSSC program began with initiatives taken by the National Science Foundation (NSF). Under an agreement with the National Institute of Standards and Technology (NIST; formerly the National Bureau of Standards), *Tentative Provisions for the Development of Seismic Regulations for Buildings* (referred to here as the *Tentative Provisions*) was prepared by the Applied Technology Council (ATC). The ATC document was described as the product of a "cooperative effort with the design professions, building code interests, and the research community" intended to "...present, in one comprehensive document, the current state of knowledge in the fields of engineering seismology and engineering practice as it pertains to seismic design and construction of buildings." The document, however, included many innovations, and the ATC explained that a careful assessment was needed.

Following the issuance of the *Tentative Provisions* in 1978, NIST released a technical note calling for ". . . systematic analysis of the logic and internal consistency of [the *Tentative Provisions*]" and developed a plan for assessing and implementing seismic design provisions for buildings. This plan called for a thorough review of the *Tentative Provisions* by all interested organizations; the conduct of trial designs to establish the technical validity of the new provisions and to assess their economic impact; the establishment of a mechanism to encourage consideration and adoption of the new provisions by organizations promulgating national standards and model codes; and educational, technical, and administrative assistance to facilitate implementation and enforcement.

During this same period, other significant events occurred. In October 1977, Congress passed the *Earthquake Hazards Reduction Act of 1977* (P.L. 95-124) and, in June 1978, the National Earthquake Hazards Reduction Program (NEHRP) was created. Further, FEMA was established as an independent agency to coordinate all emergency management functions at the federal level. Thus, the future disposition of the *Tentative Provisions* and the 1978 NIST plan shifted to FEMA. The emergence of FEMA as the agency responsible for implementation of P.L. 95-124 (as amended) and the NEHRP also required the creation of a mechanism for obtaining broad public and private consensus on both recommended improved building design and construction regulatory provisions and the means to be used in their promulgation. Following a series of meetings between representatives of the original participants in the NSF-sponsored project on seismic design provisions, FEMA, the American Society of Civil Engineers and the National Institute of Building Sciences (NIBS), the concept of the Building Seismic Safety Council was born. As the concept began to take form, progressively wider public and private participation was sought, culminating in a broadly representative organizing meeting in the spring of 1979, at which time a charter and organizational rules and procedures were thoroughly debated and agreed upon.

The BSSC provided the mechanism or forum needed to encourage consideration and adoption of the new provisions by the relevant organizations. A joint BSSC-NIST committee was formed to conduct the needed review of the *Tentative Provisions*, which resulted in 198 recommendations for changes. Another joint BSSC-NIST committee developed both the criteria by which the needed trial designs could be evaluated and the specific trial design program plan. Subsequently, a BSSC-NIST Trial Design Overview Committee was created to revise the trial design plan to accommodate a multiphased effort and to refine the *Tentative Provisions*, to the extent practicable, to reflect the recommendations generated during the earlier review.

### **Trial Designs**

Initially, the BSSC trial design effort was to be conducted in two phases and was to include trial designs for 100 new buildings in 11 major cities, but financial limitations required that the program be scaled down. Ultimately, 17 design firms were retained to prepare trial designs for 46 new buildings in 4 cities with medium to high seismic risk (10 in Los Angeles, 4 in Seattle, 6 in Memphis, 6 in Phoenix) and in 5 cities with medium to low seismic risk (3 in Charleston, South Carolina, 4 in Chicago, 3 in Ft. Worth, 7 in New York, and 3 in St. Louis). Alternative designs for six of these buildings also were included.

The firms participating in the trial design program were: ABAM Engineers, Inc.; Alfred Benesch and Company; Allen and Hoshall; Bruce C. Olsen; Datum/Moore Partnership; Ellers, Oakley, Chester, and Rike, Inc.; Enwright Associates, Inc.; Johnson and Nielsen Associates; Klein and Hoffman, Inc.; Magadini-Alagia Associates; Read Jones Christoffersen, Inc.; Robertson, Fowler, and Associates; S. B. Barnes and Associates; Skilling Ward Rogers Barkshire, Inc.; Theiss Engineers, Inc.; Weidlinger Associates; and Wheeler and Gray.

For each of the 52 designs, a set of general specifications was developed, but the responsible design engineering firms were given latitude to ensure that building design parameters were compatible with local construction practice. The designers were not permitted, however, to change the basic structural type even if an alternative structural type would have cost less than the specified type under the early version of the *Provisions*, and this constraint may have prevented some designers from selecting the most economical system.

Each building was designed twice – once according to the amended *Tentative Provisions* and again according to the prevailing local code for the particular location of the design. In this context, basic structural designs (complete enough to assess the cost of the structural portion of the building), partial structural designs (special studies to test specific parameters, provisions, or objectives), partial nonstructural designs (complete enough to assess the cost of the nonstructural portion of the building), and design/construction cost estimates were developed.

This phase of the BSSC program concluded with publication of a draft version of the recommended provisions, the *NEHRP Recommended Provisions for the Development of Seismic Regulations for New Buildings*, an overview of the *Provisions* refinement and trial design efforts, and the design firms' reports.

### **The 1985 Edition of the NEHRP Recommended Provisions**

The draft version represented an interim set of provisions pending their balloting by the BSSC member organizations. The first ballot, conducted in accordance with the BSSC Charter, was organized on a chapter-by-chapter basis. As required by BSSC procedures, the ballot provided for four responses: "yes," "yes with reservations," "no," and "abstain." All "yes with reservations" and "no" votes were to be accompanied by an explanation of the reasons for the vote and the "no" votes were to be accompanied by specific suggestions for change if those changes would change the negative vote to an affirmative.

All comments and explanations received with "yes with reservations" and "no" votes were compiled, and proposals for dealing with them were developed for consideration by the Technical Overview Committee and, subsequently, the BSSC Board of Direction. The draft provisions then were revised to reflect the changes deemed appropriate by the BSSC Board and the revision was submitted to the BSSC membership for balloting again.

As a result of this second ballot, virtually the entire provisions document received consensus approval, and a special BSSC Council meeting was held in November 1985 to resolve as many of the remaining issues as possible. The 1985 Edition of the *NEHRP Recommended Provisions* then was transmitted to FEMA for publication in December 1985.

During the next three years, a number of documents were published to support and complement the 1985 *Provisions*. They included a guide to application of the *Provisions* in earthquake-resistant building design, a nontechnical explanation of the *Provisions* for the lay reader, and a handbook for interested members of the building community and others explaining the societal implications of utilizing improved seismic safety provisions and a companion volume of selected readings.

### **The 1988 Edition**

The need for continuing revision of the *Provisions* had been anticipated since the onset of the BSSC program and the effort to update the 1985 Edition for reissuance in 1988 began in January 1986. During the update effort, nine BSSC Technical Committees (TCs) studied issues concerning seismic risk maps, structural design, foundations, concrete, masonry, steel, wood, architectural and mechanical and electrical systems, and regulatory use. The Technical Committees worked under the general direction of a Technical Management Committee (TMC), which was composed of a representative of each TC as well as additional members identified by the BSSC Board to provide balance.

The TCs and TMC worked throughout 1987 to develop specific proposals for changes needed in the 1985 *Provisions*. In December 1987, the Board reviewed these proposals and decided upon a set of 53 for submital to the BSSC membership for ballot. Approximately half of the proposals reflected new issues while the other half reflected efforts to deal with unresolved 1985 edition issues.

The balloting was conducted on a proposal-by-proposal basis in February-April 1988. Fifty of the proposals on the ballot passed and three failed. All comments and "yes with reservation" and "no" votes received as a result of the ballot were compiled for review by the TMC. Many of the comments could be addressed by making minor editorial adjustments and these were approved by the BSSC Board. Other comments were found to be unpersuasive or in need of further study during the next update cycle (to prepare the 1991 *Provisions*). A number of comments persuaded the TMC and Board that a substantial alteration of some balloted proposals was necessary, and it was decided to submit these matters (11 in all) to the BSSC membership for rebalot during June-July 1988. Nine of the eleven rebalot proposals passed and two failed.

On the basis of the ballot and rebalot results, the 1988 *Provisions* documents were prepared and transmitted to FEMA for publication in August 1988. A report describing the changes made in the 1985 edition and issues in need of attention in the next update cycle also was prepared, and efforts to update the complementary reports published to support the 1985 edition were initiated. Ultimately, the following publications were updated to reflect the 1988 Edition and reissued by FEMA: the *Guide to Application of the Provisions*, the handbook discussing societal implications (which was extensively revised and retitled *Seismic Considerations for Communities at Risk*), and several *Seismic Considerations* handbooks (which are described below).

### **The 1991 Edition**

During the effort to produce the 1991 *Provisions*, a Provisions Update Committee (PUC) and 11 Technical Subcommittees addressed seismic hazard maps, structural design criteria and analysis, foundations, cast-in-place and precast concrete structures, masonry structures, steel structures, wood structures, mechanical-electrical systems and building equipment and architectural elements, quality assurance, interface with codes and standards, and composite structures. Their work resulted in 58 substantive and 45 editorial proposals for change to the 1988 *Provisions*.

The PUC approved more than 90 percent of the proposals and, in January 1991, the BSSC Board accepted the PUC-approved proposals for balloting by the BSSC member organizations in April-May 1991.

Following the balloting, the PUC considered the comments received with "yes with reservations" and "no" votes and prepared 21 rebalot proposals for consideration by the BSSC member organizations. The rebaloting was completed in August 1991 with the approval by the BSSC member organizations of 19 of the rebalot proposals.

On the basis of the ballot and rebalot results, the 1991 *Provisions* documents were prepared and transmitted to FEMA for publication in September 1991. Reports describing the changes made in the 1988 Edition and issues in need of attention in the next update cycle also were developed.

In August 1992, in response to a request from FEMA, the BSSC initiated an effort to continue its structured information dissemination and instruction/training effort aimed at stimulating widespread use of the *Provisions*. The primary objectives of the effort were to bring several of the publications complementing the *Provisions* into conformance with the 1991 Edition in a manner reflecting other related developments (e.g., the fact that all three model codes now include requirements based on the *Provisions*) and to bring instructional course materials currently being used in the BSSC seminar series (described below) into conformance with the 1991 *Provisions*.

### **The 1994 Edition**

The effort to structure the 1994 PUC and its technical subcommittees was initiated in late 1991. By early 1992, 12 Technical Subcommittees (TSs) were established to address seismic hazard mapping, loads and analysis criteria, foundations and geotechnical considerations, cast-in-place and precast concrete structures, masonry structures, steel structures, wood structures, mechanical-electrical systems and building equipment and architectural elements, quality assurance, interface with codes and standards, and composite steel and concrete structures, and base isolation/energy dissipation.

The TSs worked throughout 1992 and 1993 and, at a December 1994 meeting, the PUC voted to forward 52 proposals to the BSSC Board with its recommendation that they be submitted to the BSSC member organizations for balloting. Three proposals not approved by the PUC also were forwarded to the Board because 20 percent of the PUC members present at the meeting voted to do so. Subsequently, an additional proposal to address needed terminology changes also was developed and forwarded to the Board.

The Board subsequently accepted the PUC-approved proposals; it also accepted one of the proposals submitted under the "20 percent" rule but revised the proposal to be balloted as four separate items. The BSSC member organization balloting of the resulting 57 proposals occurred in March-May 1994, with 42 of the 54 voting member organizations submitting their ballots. Fifty-three of the proposals passed, and the ballot results and comments were reviewed by the PUC in July 1994. Twenty substantive changes that would require rebaloting were identified. Of the four proposals that failed the ballot, three were withdrawn by the TS chairmen and one was substantially modified and also was accepted for rebaloting. The BSSC Board of Direction accepted the PUC recommendations except in one case where it deemed comments to be persuasive and made an additional substantive change to be rebaloted by the BSSC member organizations.

The second ballot package composed of 22 changes was considered by the BSSC member organizations in September-October 1994. The PUC then assessed the second ballot results and made its recommendations to the BSSC Board in November. One needed revision identified later was considered by the PUC Executive Committee in December. The final copy of the 1994 Edition of the *Provisions* including a summary of the differences between the 1991 and 1994 Editions was delivered to FEMA in March 1995.



## **1997 Update Effort**

In September 1994, NIBS entered into a contract with FEMA for initiation of the 39-month BSSC 1997 *Provisions* update effort. Late in 1994, the BSSC member organization representatives and alternate representatives and the BSSC Board of Direction were asked to identify individuals to serve on the 1997 PUC and its TSs. The 1997 PUC was constituted early in 1995, and 12 PUC Technical Subcommittees were established to address design criteria and analysis, foundations and geotechnical considerations, cast-in-place/precast concrete structures, masonry structures, steel structures, wood structures, mechanical-electrical systems and building equipment and architectural elements, quality assurance, interface with codes and standards, composite steel and concrete structures, energy dissipation and base isolation, and nonbuilding structures.

As part of this effort, the BSSC developed for the 1997 *Provisions* a revised seismic design procedure. Unlike the design procedure based on U.S. Geological Survey (USGS) peak acceleration and peak velocity-related acceleration ground motion maps developed in the 1970s and used in earlier editions of the *Provisions*, the new design procedure involves new design maps based on recently revised USGS spectral response maps and a process specified within the body of the *Provisions*. This task was conducted with the cooperation of the USGS (under a Memorandum of Understanding signed by the BSSC and USGS) by the Seismic Design Procedure Group (SDPG) working with the guidance of a five-member Management Committee.

More than 200 individuals participated in the 1997 update effort, and more than 165 substantive proposals for change were developed. A series of editorial/organizational changes also were made. All draft TS, SDPG, and PUC proposals for change were finalized in late February 1997, and in early March, the PUC Chair presented to the BSSC Board of Direction the PUC's recommendations concerning proposals for change to be submitted to the BSSC member organizations for balloting. The Board accepted these recommendations, and the first round of balloting was conducted in April-June 1997.

Of the 158 items on the first ballot, only 8 did not pass; however, many comments were submitted with "no" and "yes with reservations" votes. These comments were compiled for distribution to the PUC, which met in mid-July to review the comments, receive TS responses to the comments and recommendations for change, and formulate its recommendations concerning what items should be submitted to the BSSC member organizations for a second ballot. The PUC deliberations resulted in the decision to recommend to the BSSC Board that 28 items be included in the second ballot. The PUC Chair subsequently presented the PUC's recommendations to the Board, which accepted those recommendations.

The second round of balloting was completed in October. All but one proposal passed; however, a number of comments on virtually all the proposals were submitted with the ballots and were immediately compiled for consideration by the PUC. The PUC Executive Committee met in December to formulate its recommendations to the Board, and the Board subsequently accepted those recommendations.

The PUC concluded its update work by identifying issues in need of consideration during the next update cycle and technical issues in need of study. The final version of the 1997 *Provisions*, including an appendix describing the differences between the 1994 and 1997 edition, was transmitted to FEMA in February 1998. The contract for the 1997 update effort has been extended by FEMA to June 30, 1998, to permit development of a CD-ROM for presentation of the design map data.

## **Code Resource Development Effort**

In mid-1996, FEMA asked the BSSC to initiate an effort to generate a code resource document based on the 1997 *Provisions* for use by the International Code Council (ICC) in adopting seismic provisions for the first edition of the *International Building Code (IBC)* to be published in 2000.

The orientation meeting of the Code Resource Development Committee (CRDC) appointed to conduct this effort was held in Denver on October 17. At this meeting, the group was briefed on the status of the *Provisions* update effort and formulated a tentative plan and schedule for its efforts.

The group next met in January 1997 to review a preliminary code language/format version of the 1997 *Provisions* and to develop additional needed input. As a result of this meeting, several task groups were established to focus on specific topics and to provide revisions to the preliminary draft. A new draft incorporating these comments then was developed for further refinement by the CRDC. A copy also was delivered to the members of the *IBC* Structural Subcommittee so that they could begin determining how the seismic provisions would fit into their code requirements.

The CRDC met again in February to review the second draft of the code language/format version of the 1997 *Provisions*. This meeting was held just preceding a PUC meeting and changes made by the PUC subsequently were incorporated into the CRDC draft. The CRDC Chair presented this composite draft to the *IBC* Structural Subcommittee in March 1997.

In July, the CRDC met to develop comments on the *IBC* working draft to be submitted to the ICC in preparation for an August public comment forum. These comments generally reflected actions taken by the PUC in response to comments submitted with the first ballot on the changes proposed for the 1997 *Provisions* as well as CRDC recommendations concerning changes made by the *IBC* Structural Subcommittee in the original CRDC submittal. CRDC representatives then attended the August forum to support the CRDC recommendations.

The CRDC then met in December to prepare “code change proposals” on the first published version of the *IBC*. The proposed “code changes” developed by the committee were submitted to the *IBC* on January 5, 1998. The group is next meeting in March to review the changes to the draft *IBC* proposed by others to assist CRDC representatives who will attend a public hearing on the draft *IBC* in April 1998. Subsequent efforts are expected to focus on supporting the CRDC-developed provisions throughout the code adoption process.

In addition, a task group of the CRDC was established in late-1997 to provide the ICC committee developing the the *International Residential Dwelling Code* with input concerning seismic requirements reflecting the 1997 *Provisions*. The activities of this task group are expected to parallel those of the CRDC with the *IBC*.

### **The 2000 Edition**

In September 1997, NIBS entered into a contract with FEMA for initiation of the 48-month BSSC effort to update the 1997 *NEHRP Recommended Provisions for Seismic Regulations for New Buildings and Other Structures* for re-issuance in 2000 and prepare code changes based on the 2000 *Provisions* for submittal to the *IBC*. The BSSC member organization representatives and alternate representatives and the BSSC Board of Direction were asked to identify candidates to participate; the individuals serving on the 1997 update committees were contacted to determine if they are interested in participating in the new effort; and a press release on the 2000 update effort was issued.

In lieu of the Seismic Design Procedure Group (SDPG) used in the 1997 update, the BSSC is re-establishing Technical Subcommittee 1, Seismic Design Mapping, which was used in earlier updates of the *Provisions*. This subcommittee will be composed of an equal number of representatives from the earth science community, including representatives from the USGS, and the engineering community. A sufficient number of members of the SDPG will be included to ensure a smooth transition.

An additional 11 subcommittees will address seismic design and analysis, foundations and geotechnical considerations, cast-in-place and precast concrete structures, masonry structures, steel structures, wood structures, mechanical-electrical systems and building equipment and architectural elements, quality assurance, composite steel and concrete structures, base isolation and energy dissipation, and nonbuilding struc-

tures and one ad hoc task group to develop appropriate anchorage requirements for concrete/masonry/wood elements. Unlike earlier updates, it is not anticipated that a technical subcommittee will be appointed to serve as the interface with codes and standards; rather, the PUC will appoint a task group to serve as the liaison with the the model code and standards organizations and three model code representatives will serve on the PUC.

The BSSC, through the PUC and its TSs, will identify major technical issues to be addressed during the 2000 update of the *Provisions*, assess the basis for change to the 1997 Edition, resolve technical issues, and develop proposals for change. The results of recent relevant research and lessons learned from earthquakes occurring prior to and during the duration of the project will be given consideration at all stages of this process. Particular attention will be focused on those technical problems identified but unresolved during the preparation of the 1997 Edition. Attention also will be given to the improvement of criteria to eventually allow for design based on desired building performance levels, an approach taken in the *NEHRP Guidelines for the Seismic Rehabilitation of Buildings*.

The PUC also will coordinate its efforts with those individuals working with the ICC to develop the *IBC*. Changes recommended by those individuals will be submitted to the PUC for consideration and changes developed by the PUC will be formatted for consideration in the *IBC* development process.

As part of the update process, the BSSC also will develop a simplified design procedure in order to facilitate use of the *Provisions* in areas of low and moderate seismic hazard. This process will be performed by a separate task group reporting directly to TS2, Seismic Design and Analysis.

As in previous update efforts, two rounds of balloting by the BSSC member organizations are planned, and delivery of the final consensus-approved 2000 *Provisions* is expected to occur in December 2000. An appendix identifying the major differences between the 1997 and the 2000 editions of the *Provisions* will be included in the *Provisions* volume and a letter report describing unresolved issues and major technical topics in need of further study also will be prepared.

Following completion of the 2000 *Provisions*, the BSSC will establish a procedure whereby code language versions of changes to the *Provisions* will be prepared for submittal as proposed code changes for the 2003 Edition of the *IBC*. These code changes will be developed for PUC consideration and approval by a Code Liaison Group with the assistance of a consultant experienced in the code change process. In addition, the BSSC will designate three members of the PUC who, along with the consultant, will formally submit the code changes prior to the *IBC* deadline.

The 2000 PUC met for the first time in February 1998 to develop a schedule for its work, review the charges to the technical subcommittees, and consider how best to deal with unresolved issues and coordinate with the BSSC work devoted to the *IBC* effort.

### **Information Dissemination/Technology Transfer**

The BSSC continues in its efforts to stimulate widespread use of the *Provisions*. In addition to the issuance of a variety of publications that complement the *Provisions*, over the past seven years the BSSC has developed materials for use in and promoted the conduct of a series of seminars on application of the *Provisions* among relevant professional associations. To date, more than 90 of these seminars have been conducted with a wide variety of cosponsors and more than 70,000 reports have been distributed.

Other information dissemination efforts have involved the participation of BSSC representatives in a wide variety of meetings and conferences, BSSC participation in development of curriculum for a FEMA Emergency Management Institute course on the *Provisions* for structural engineers and other design professionals, issuance of press releases, development of in-depth articles for the publications of relevant groups, work with Building Officials and Code Administrators International (BOCA) that resulted in use of the *Provisions* in the BOCA *National Building Code* and the Southern Building Code Congress International's *Standard*

*Building Code*, and cooperation with the American Society of Civil Engineers (ASCE) that resulted in use of the *Provisions* in the 1993 and 1995 Editions of Standard ASCE 7. In addition, many requests for specific types of information and other forms of technical support are received and responded to monthly.

During 1996, as part of the efforts of a joint committee of the BSSC, Central U.S. Earthquake Consortium, Southern Building Code Congress International and Insurance Institute for Property Loss Reduction to develop mechanisms for the seismic training of building code officials, the BSSC contributed its expertise in the development of a manual for use in such training efforts.

Information dissemination efforts during 1997 have been somewhat curtailed so that resources can be devoted to introduction of the 1997 *Provisions* and related efforts. In this regard, NIBS has requested and received an extension of its existing information dissemination contract with FEMA through September 1998 to permit, among other things, work on revised versions of the *Nontechnical Explanation of the NEHRP Recommended Provisions*, *Guide to Application of the Provisions*, and *Provisions* educational/training materials to reflect the 1997 Edition. In addition, it is anticipated that development of an Internet/Web site devoted to the 1997 *Provisions* and the 2000 update effort will be initiated.

## **IMPROVING THE SEISMIC SAFETY OF EXISTING BUILDINGS**

### ***Guidelines/Commentary Development Project***

In August 1991, NIBS entered into a cooperative agreement with FEMA for a comprehensive 6-year program leading to the development of a set of nationally applicable guidelines for the seismic rehabilitation of existing buildings. Under this agreement, the BSSC serves as program manager with the American Society of Civil Engineers (ASCE) and the Applied Technology Council (ATC) working as subcontractors. Initially, FEMA provided funding for a program definition activity designed to generate the detailed work plan for the overall program. The work plan was completed in April 1992 and in September FEMA contracted with NIBS for the remainder of the effort.

The major objectives of the project were to develop a set of technically sound, nationally applicable guidelines (with commentary) for the seismic rehabilitation of buildings to serve as a primary resource on the seismic rehabilitation of buildings for the use of design professionals, model code and standards organizations, state and local building regulatory personnel, and educators; to develop building community consensus regarding the guidelines; and to develop the basis of a plan for stimulating widespread acceptance and application of the guidelines.

The project work was structured to ensure that the technical guidelines writing effort benefits from: consideration of the results of completed and ongoing technical efforts and research activities as well as societal issues, public policy concerns, and the recommendations presented in an earlier FEMA-funded report on issues identification and resolution; cost data on application of rehabilitation procedures; the reactions of potential users; and consensus review by a broad spectrum of building community interests.

While overall management remained the responsibility of the BSSC, responsibility for conduct of the specific project tasks were shared by the BSSC with ASCE (which organized user workshops and conducted literature review and other research activities) and ATC (which was responsible for drafting the *Guidelines*, its *Commentary*, and a volume of example applications as well as conducting a study to assess the validity of several concepts being proposed for use in the *Guidelines*). Specific BSSC tasks were conducted under the guidance of a BSSC Project Committee. To ensure project continuity and direction, a Project Oversight Committee (POC) was responsible to the BSSC Board for accomplishment of the project objectives and the conduct of project tasks. Further, a Seismic Rehabilitation Advisory Panel was established to review project products and to advise the POC and, if appropriate, the BSSC Board, on the approach being taken, problems arising or

anticipated, and progress being made. In addition, three workshops were held over the course of the project to provide the *Guidelines/Commentary* writers with input from potential users of the documents.

The BSSC Board of Direction accepted the 100-percent-complete draft of the *Guidelines* and *Commentary* for consensus balloting in mid-August 1996. The first round of balloting occurred in October-December with a ballot symposium for the voting representatives held in November 1996.

The *Guidelines* and *Commentary* were approved by the BSSC membership; however, a significant number of comments were received. The ATC Senior Technical Committee reviewed these comments in detail and commissioned members of the technical teams that developed the *Guidelines* to develop detailed responses and to formulate any needed proposals for change reflecting the comments. This effort resulted in 48 proposals for change to be submitted to the BSSC member organizations for a second round of balloting.

Following acceptance of the second ballot materials by the BSSC Board, the voting occurred in June-July 1997. Again the results were compiled for review by ATC. Meeting in September 1997, the Project Oversight Committee received recommendations from ATC regarding comment resolution; it was concluded that none of the changes proposed in response to ballot comments were sufficiently substantive to warrant reballoting. Subsequently, the POC conclusion was presented to the BSSC Board, which agreed and approved finalization of the *Guidelines* and *Commentary* for submittal to FEMA for publication. The final versions of the documents then were prepared and transmitted to FEMA in September 1998 and published copies became available in March 1998.

During the course of the project, BSSC Project Committee recommendations resulted in the following additions to the NIBS/BSSC contract with FEMA for the project: the BSSC ballot symposium for voting representatives mentioned above; the case studies program described below; and an effort to develop the curriculum for and conduct a series of two-day educational seminars to introduce and provide training in use of the *Guidelines* to practicing structural and architectural engineers, seismic engineering educators and students, building officials and technical staff, interested contractors, hazard mitigation officers, and others.

### **Case Studies Project**

As noted above, the case studies project is an extension of the multiyear project leading to publication of the *NEHRP Guidelines for the Seismic Rehabilitation of Buildings* and its *Commentary*. The project is expected to contribute to the credibility of the *Guidelines* by providing potential users with representative real-world application data and to provide FEMA with the information needed to determine whether and when to update the *Guidelines*.

Although the *Guidelines* documents reflect expert experience, current research, and innovative theories, the case studies project is expected to answer a number of critical questions: Can the *Guidelines* and its *Commentary* be understood and applied by practicing design professionals of varying levels of experience? Do the *Guidelines* result in rational designs generated in a reasonable and logical way? What are the costs involved in seismically rehabilitating various types of buildings to the optional levels of performance both above and below the *Guidelines*' "basic safety objective"? Are the requirements to achieve the "basic safety objective" equivalent to, less stringent than, or more stringent than current practice for new construction?

Specifically, the objectives of the project are to: (a) test the usability of the *NEHRP Guidelines for the Seismic Rehabilitation of Buildings* in authentic applications in order to determine the extent to which practicing design engineers and architects find the *Guidelines* documents, including the structural analysis procedures and acceptance criteria, to be presented in understandable language and in a clear, logical fashion that permits valid engineering determinations to be made, and evaluate the ease of transition from current engineering practices to the new concepts presented in the *Guidelines*; (b) assess the technical adequacy of the *Guidelines* design and analysis procedures to determine if application of the procedures results (in the judgment of the designer) in rational designs of building components for corrective rehabilitation measures

and whether the designs that result adequately meet the selected performance levels when compared to current practice and in light of the knowledge and experience of the designer; (c) assess whether the *Guidelines* acceptance criteria are properly calibrated to result in component designs that provide permissible values of such key factors as drift, component strength demand, and inelastic deformation at selected performance levels; (d) develop data on the costs of rehabilitation design and construction to meet the *Guidelines*' "basic safety objective" as well as the higher performance levels included and assess whether the anticipated higher costs of advanced engineering analysis result in worthwhile savings compared to the cost of constructing more conservative design solutions arrived at by a less systematic engineering effort; and (e) compare the acceptance criteria of the *Guidelines* with the prevailing seismic design requirements for new buildings in the building location to determine whether requirements for achieving the *Guidelines*' "basic safety objective" are equivalent to or more or less stringent than those expected of new buildings.

It is planned that seismic rehabilitation designs will be developed for approximately 40 buildings selected insofar as practicable from an inventory of buildings already determined to be seismically deficient under the implementation program of Executive Order 12941 and considered "typical of existing structures located throughout the nation." Where federal buildings from this inventory do not represent the full spectrum of buildings which need to be studied, case study candidates have been sought from among privately owned buildings or those owned by other levels of government. Qualified structural engineering or architectural/engineering (A/E) firms will be engaged to produce detailed designs for seismic rehabilitation of the lateral-load-resisting systems, foundations, and critical nonstructural elements of the selected buildings, and to make specified comparisons with current practices and costs. Each design contractor's products and experiences using the *Guidelines* will be assessed in order to generate credible data that will establish the technical validity of the *Guidelines*, define their economic impact, and identify any needed changes in the *Guidelines* or highlight areas in need of research and investigation before a *Guidelines* update is planned. Many parameters and possible combinations thereof will be considered in addition to basic building types and seismic deficiencies.

The case studies will include consideration of numerous design approaches, options, and determinations to give a balanced representation, within the resources available, of the following factors: different performance levels and ranges, both systematic (linear/nonlinear, static/dynamic) and simplified analysis methods as presented in the *Guidelines*, alternate designs and cost comparisons for the same building provided by more than one design firm, different structural systems, varying seismicity (high, medium, and low), short and stiff versus tall and flexible building types, rehabilitation *Guidelines* compared to current new construction practices, geographic dispersion of cases among seismic risk areas, presence of auxiliary energy dispersion systems or base isolation, and historical preservation status of building.

The project is being guided by the Case Studies Project Committee (CSPC). At its organization meeting in May 1997, the CSPC reviewed the background and structure of the project, developed an initial work plan/project schedule, and defined the roles of the various participants. The CSPC also established three subcommittees to address the development of criteria for building selection, design professional selection, and contractor requests for proposals. In addition to the architects/engineers who will be engaged to perform the case studies designs, the project will utilize a paid Project Technical Advisor and a Design Assessment Panel of professionals knowledgeable about the content and use of the *Guidelines*.

In July, the CSPC met again to review letters of interest and resumes for the advertised position of the Project Technical Advisor; initial selection recommendations were developed for action by the BSSC Board and subsequently resulted in a contract with Andrew T. Merovich of A. T. Merovich and Associates, San Francisco, California. The subcommittee responsible for development of building selection criteria also presented a matrix for the selection and matching of available buildings.

The case studies project was posted in the *Commerce Business Daily* and in the Official Proposals section of *Engineering News Record*. These postings resulted in receipt of 149 expressions of interest; of these, 133 appeared to be qualified to move into the next stage of the selection process.

The CSPC met again in early December to finalize the list of buildings recommended for study, approve a draft of the "Request for Qualifications" (RFQ) and contractor selection criteria, and identify individuals to serve on the Design Assessment Panel.

In December 1997 and January 1998, the qualified design firms were asked to supply additional information on their detailed qualifications and to identify which of the available case study buildings they wished to design. Over 120 responses were received.

A CSPC task group met on February 9-11, 1998, to match the candidate firms with the available buildings based on the experience and interest of the firms and the level of complexity assigned to each building. The full CSPC met on February 12 to confirm which firms are to be asked for price solicitations, and second and third choice firms also were identified. Successful firms were notified on February 9. It is anticipated that bid packages (including statements of work and building data) will be completed by mid-March and furnished to the first-choice firms shortly thereafter.

The latest project schedule shows the case study designs being accomplished from May through September 1998 with the final project report to be submitted to FEMA by the end of March 1999.

### **Earlier Projects Focusing on Evaluation and Rehabilitation Techniques**

An earlier FEMA-funded project was designed to provide consensus-backed approval of publications on seismic hazard evaluation and strengthening techniques for existing buildings. This effort involved identifying and resolving major technical issues in two preliminary documents developed for FEMA by others – a handbook for seismic evaluation of existing buildings prepared by the Applied Technology Council (ATC) and a handbook of techniques for rehabilitating existing buildings to resist seismic forces prepared by URS/John A. Blume and Associates (URS/Blume); revising the documents for balloting by the BSSC membership; balloting the documents in accordance with the BSSC Charter; assessing the ballot results; developing proposals to resolve the issues raised; identifying any unresolvable issues; and preparing copies of the documents that reflect the results of the balloting and a summary of changes made and unresolved issues. Basically, this consensus project was directed by the BSSC Board and a 22-member Retrofit of Existing Buildings (REB) Committee composed of individuals representing the needed disciplines and geographical areas and possessing special expertise in the seismic rehabilitation of existing buildings. The consensus approved documents (the *NEHRP Handbook for the Seismic Evaluation of Existing Buildings* and the *NEHRP Handbook of Techniques for the Seismic Rehabilitation of Existing Buildings*) were transmitted to FEMA in mid-1992.

The BSSC also was involved in an even earlier project with the ATC and the Earthquake Engineering Research Institute to develop an action plan for reducing earthquake hazards to existing buildings. The action plan that resulted from this effort prompted FEMA to fund a number of projects, including those described above.

### **Assessment of the San Francisco Opera House**

In October 1994, the NIBS-BSSC initiated an effort to provide FEMA with objective expert advice concerning the San Francisco War Memorial Opera House. The Opera House, constructed circa 1920 with a steel frame clad and infilled with masonry, was damaged in the Loma Prieta earthquake and the city of San Francisco subsequently petitioned FEMA for supplemental funding of approximately \$33 million to cover the costs of a complete seismic upgrade of the building under the *Stafford Act*, which provides funding for work when local building code upgrade requirements are met. In this case, the *San Francisco Building Code* was the local code in effect. The effort was structured to involve three phases, if warranted, and was to be

conducted by a three-member Independent Review Panel of experts knowledgeable and experienced in building codes and building code administration.

During Phase I, the Review Panel conducted an unbiased, expert review of the applicable code sections pertinent to the repair of earthquake damage in order to provide FEMA with a definitive interpretation of such terms as “how much” change/repair of “what nature” would be sufficient to require complete seismic upgrading of a building of the same general type and construction as the Opera House. It reviewed all relevant, immediately available information about the Opera House case provided by FEMA and the city and the relevant portions of the *San Francisco Building Code* and other similar building codes pertinent to the repair of earthquake-caused damage to buildings and prepared and delivered to FEMA in February 1995 a preliminary report of its findings.

At this point, the Panel was informed by FEMA that the city of San Francisco had rescinded its request indicating that the “proposed determination on eligibility for funding through review and recommendation by an independent and impartial review body from NIBS” would not be necessary. Later, however, FEMA asked that NIBS-BSSC complete Phase I so that it would be better prepared should other similar situations arise. Thus, the Panel continued and delivered a final report to FEMA in July 1995.

## **IMPROVING THE SEISMIC SAFETY OF NEW AND EXISTING LIFELINES**

Given the fact that buildings continue to be useful in a seismic emergency only if the services on which they depend continue to function, the BSSC developed an action plan for the abatement of seismic hazards to lifelines to provide FEMA and other government agencies and private sector organizations with a basis for their long-range planning. The action plan was developed through a consensus process utilizing the special talents of individuals and organizations involved in the planning, design, construction, operation, and regulation of lifeline facilities and systems.

Five lifeline categories were considered: water and sewer facilities, transportation facilities, communication facilities, electric power facilities, and gas and liquid fuel lines. A workshop involving more than 65 participants and the preparation of over 40 issue papers was held. Each lifeline category was addressed by a separate panel and overview groups focused on political, economic, social, legal, regulatory, and seismic risk issues. An Action Plan Committee composed of the chairman of each workshop panel and overview group was appointed to draft the final action plan for review and comment by all workshop participants. The project reports, including the action plan and a definitive six-volume set of workshop proceedings, were transmitted to FEMA in May 1987.

In recognition of both the complexity and importance of lifelines and their susceptibility to disruption as a result of earthquakes and other natural hazards (hurricanes, tornadoes, flooding), FEMA subsequently concluded that the lifeline problem could best be approached through a nationally coordinated and structured program aimed at abating the risk to lifelines from earthquakes as well as other natural hazards. Thus, in 1988, FEMA asked the BSSC's parent institution, the National Institute of Buildings Sciences, to provide expert recommendations concerning appropriate and effective strategies and approaches to use in implementing such a program.

The effort, conducted for NIBS by an ad hoc Panel on Lifelines with the assistance of the BSSC, resulted in a report recommending that the federal government, working through FEMA, structure a nationally coordinated, comprehensive program for mitigating the risk to lifelines from seismic and other natural hazards that focuses on awareness and education, vulnerability assessment, design criteria and standards, regulatory policy, and continuing guidance. Identified were a number of specific actions to be taken during the next three to six years to initiate the program.



## **MULTIHAZARD ACTIVITIES**

### **Multihazard Assessment Forum**

In 1993, FEMA contracted with NIBS for the BSSC to organize and hold a forum intended to explore how best to formulate an integrated approach to mitigating the effects of various natural hazards under the National Earthquake Hazards Reduction Program. More than 50 experts in various disciplines concerning natural hazards risk abatement participated in the June 1994 forum and articulated the benefits of pursuing an integrated approach to natural hazards risk abatement. A BSSC steering committee then developed a report, *An Integrated Approach to Natural Hazards Risk Mitigation*, based on the forum presentations and discussion that urged FEMA to initiate an effort to create a National Multihazard Mitigation Council structured and charged to integrate and coordinate public and private efforts to mitigate the risk from natural hazards. This report was delivered to FEMA in early 1995.

### **Multihazard Council Program Definition and Initiation**

In September 1995, the BSSC negotiated with FEMA a modification of an existing contract to provide for conduct of the first phase of a longer term effort devoted to stimulating the application of technology and experience data in mitigating the risks to buildings posed by multiple natural hazards and development of natural hazard risk mitigation measures and provisions that are national in scope for use by those involved in the planning, design, construction, regulation, and utilization of the built environment. During this first phase, the BSSC is conducting a program definition and initiation effort expected to culminate in the establishment of a National Multihazard Mitigation Council (NMMC) to integrate and coordinate public and private efforts to mitigate the risks associated with natural hazards as recommended in the report cited above.

To conduct the project, the BSSC established a 12-member "blue ribbon" Multihazard Project Steering Committee (MPSC) composed of well-respected leaders in the natural hazards risk mitigation community. The MPSC, which met in July and December 1996 and February 1997, developed an organizational structure for the proposed council, a draft charter, a draft mission statement, and a preliminary outline for a work plan. Due consideration has been given to the fact that the proposed council will need to maximize the use of resources through mitigation of risks utilizing common measures; promote cost-effective loss reduction, effective technology transfer, conflict identification, and coordination of performance objectives; improve efficiency in the development of codes and standards; provide an open forum for articulation of different needs and perspectives; facilitate policy adoption and implementation; fill educational and public awareness needs; and provide a single credible source for recommendations and directions. In addition, the MPSC is responsible for formulating and directing implementation of a strategy for effectively stimulating the level of interest and degree of cooperation among the various constituencies needed to establish the proposed council.

One of the major project milestones was the organization and conduct of a September 8-10 forum to review the proposed charter, mission statement, and five-year plan. Almost 80 individuals attended. Following background presentations and status reports on current mitigation-related activities, the forum was devoted primarily to presentation and discussion of the preliminary goals and objectives of the proposed council; the proposed NMMC Charter, home/organization, and membership; proposed activities to be included in the five-year plan for the NMMC; and the Steering Committee's candidates for the initial NMMC board. In essence, the forum participants gave consensus approval to the proposed goals, objectives, charter, and membership of the Council and accepted NIBS as the most likely candidate to serve as the home organization of the NMMC.

At its November 1997 meeting, the NIBS Board of Directors reviewed the goals/objectives and activities statements and charter for the NMMC as discussed at the forum. They accepted the charter with some

changes. The new council, to be called the Multihazard Mitigation Council (MMC), will now be a sister council to the BSSC and other NIBS councils.

### **EMI Multihazard Building Design Summer Institute**

In 1994, NIBS, at the request of FEMA's Emergency Management Institute (EMI), entered into a contract for BSSC to provide support for the of the EMI Multihazard Building Design Summer Institute (MBDSI) for university and college professors of engineering and architecture. The 1995 MBDSI, conducted in July 1995, consisted of four one-week courses structured to encourage widespread use of mitigation techniques in designing/rehabilitating structures to withstand forces generated by both natural and technological hazards by providing the attending academics with instructional tools for use in creating/updating building design courses.



## BSSC MEMBER ORGANIZATIONS

AFL-CIO Building and Construction Trades  
Department  
AISC Marketing, Inc.  
American Concrete Institute  
American Consulting Engineers Council  
American Forest and Paper Association  
American Institute of Architects  
American Institute of Steel Construction  
American Insurance Services Group, Inc.  
American Iron and Steel Institute  
American Plywood Association  
American Society of Civil Engineers  
American Society of Civil Engineers--Kansas City  
Chapter  
American Society of Heating, Refrigeration, and Air-  
Conditioning Engineers  
American Society of Mechanical Engineers  
American Welding Society  
Applied Technology Council  
Associated General Contractors of America  
Association of Engineering Geologists  
Association of Major City Building Officials  
Bay Area Structural, Inc.\*  
Brick Institute of America  
Building Officials and Code Administrators  
International  
Building Owners and Managers Association  
International  
Building Technology, Incorporated\*  
California Geotechnical Engineers Association  
California Division of the State Architect, Office  
of Regulation Services  
Canadian National Committee on Earthquake  
Engineering  
Concrete Masonry Association of California and  
Nevada  
Concrete Reinforcing Steel Institute  
Earthquake Engineering Research Institute  
General Reinsurance Corporation\*  
Hawaii State Earthquake Advisory Board  
Insulating Concrete Form Association  
Institute for Business and Home Safety  
Interagency Committee on Seismic Safety in  
Construction  
International Conference of Building Officials  
International Masonry Institute  
Masonry Institute of America  
Metal Building Manufacturers Association  
National Association of Home Builders  
National Concrete Masonry Association  
National Conference of States on Building Codes  
and Standards  
National Council of Structural Engineers  
Associations  
National Elevator Industry, Inc.  
National Fire Sprinkler Association  
National Institute of Building Sciences  
National Ready Mixed Concrete Association  
Permanent Commission for Structural Safety of  
Buildings\*  
Portland Cement Association  
Precast/Prestressed Concrete Institute  
Rack Manufacturers Institute  
Seismic Safety Commission (California)  
Southern Building Code Congress International  
Southern California Gas Company\*  
Steel Deck Institute, Inc.  
Steel Joist Institute\*  
Steven Winter Associates, Inc.\*  
Structural Engineers Association of Arizona  
Structural Engineers Association of California  
Structural Engineers Association of Central  
California  
Structural Engineers Association of Colorado  
Structural Engineers Association of Illinois  
Structural Engineers Association of Northern  
California  
Structural Engineers Association of Oregon  
Structural Engineers Association of San Diego  
Structural Engineers Association of Southern  
California  
Structural Engineers Association of Utah  
Structural Engineers Association of Washington  
The Masonry Society  
U. S. Postal Service\*  
Western States Clay Products Association  
Western States Council Structural Engineers  
Association  
Westinghouse Electric Corporation\*  
Wire Reinforcement Institute, Inc.

\* Affiliate (non-voting) members.

(January 1998)

# BUILDING SEISMIC SAFETY COUNCIL PUBLICATIONS

Available free from the Federal Emergency Management Agency at 1-800-480-2520  
(order by FEMA Publication Number)

For detailed information about the BSSC and its projects, contact:  
BSSC, 1090 Vermont Avenue, N.W., Suite 700, Washington, D.C. 20005  
Phone 202-289-7800; Fax 202-289-1092; e-mail [cheider@NIBS.ORG](mailto:cheider@NIBS.ORG)

## NEW BUILDINGS PUBLICATIONS

*The NEHRP (National Earthquake Hazards Reduction Program) Recommended Provisions for Seismic Regulations for New Buildings*, 1997 Edition, 2 volumes and maps (FEMA Publication 302 and 303)—printed copies expected to be available in early 1998.

*The NEHRP (National Earthquake Hazards Reduction Program) Recommended Provisions for Seismic Regulations for New Buildings*, 1994 Edition, 2 volumes and maps (FEMA Publications 222A and 223A).

*The NEHRP (National Earthquake Hazards Reduction Program) Recommended Provisions for the Development of Seismic Regulations for New Buildings*, 1991 Edition, 2 volumes and maps (FEMA Publications 222 and 223) — limited to existing supply.

*Guide to Application of the 1991 Edition of the NEHRP Recommended Provisions in Earthquake Resistant Building Design*, Revised Edition, 1995 (FEMA Publication 140)

*A Nontechnical Explanation of the NEHRP Recommended Provisions*, Revised Edition, 1995 (FEMA Publication 99)

*Seismic Considerations for Communities at Risk*, Revised Edition, 1995 (FEMA Publication 83)

*Seismic Considerations: Apartment Buildings*, Revised Edition, 1996 (FEMA Publication 152)

*Seismic Considerations: Elementary and Secondary Schools*, Revised Edition, 1990 (FEMA Publication 149)

*Seismic Considerations: Health Care Facilities*, Revised Edition, 1990 (FEMA Publication 150)

*Seismic Considerations: Hotels and Motels*, Revised Edition, 1990 (FEMA Publication 151)

*Seismic Considerations: Office Buildings*, Revised Edition, 1996 (FEMA Publication 153)

*Societal Implications: Selected Readings*, 1985 (FEMA Publications 84)

## EXISTING BUILDINGS PUBLICATIONS

*NEHRP Guidelines for the Seismic Rehabilitation of Buildings*, 1997 (FEMA Publication 273)

*NEHRP Guidelines for the Seismic Rehabilitation of Buildings: Commentary*, 1997 (FEMA Publication 274)

*Planning for Seismic Rehabilitation: Societal Issues*, 1998

*Example Applications of the NEHRP Guidelines for the Seismic Rehabilitation of Buildings*, to be available in mid-1998 (FEMA Publication 276)

*NEHRP Handbook of Techniques for the Seismic Rehabilitation of Existing Buildings*, 1992 (FEMA Publication 172)

*NEHRP Handbook for the Seismic Evaluation of Existing Buildings*, 1992 (FEMA Publication 178)

*An Action Plan for Reducing Earthquake Hazards of Existing Buildings*, 1985 (FEMA Publication 90)

## **MULTIHAZARD PUBLICATIONS**

*An Integrated Approach to Natural Hazard Risk Mitigation*, 1995 (FEMA Publication 261/2-95)

## **LIFELINES PUBLICATIONS**

*Abatement of Seismic Hazards to Lifelines: An Action Plan*, 1987 (FEMA Publication 142)

*Abatement of Seismic Hazards to Lifelines: Proceedings of a Workshop on Development of An Action Plan*, 6 volumes:

*Papers on Water and Sewer Lifelines*, 1987 (FEMA Publication 135)

*Papers on Transportation Lifelines*, 1987 (FEMA Publication 136)

*Papers on Communication Lifelines*, 1987 (FEMA Publication 137)

*Papers on Power Lifelines*, 1987 (FEMA Publication 138)

*Papers on Gas and Liquid Fuel Lifelines*, 1987 (FEMA Publication 139)

*Papers on Political, Economic, Social, Legal, and Regulatory Issues and General Workshop Presentations*, 1987 (FEMA Publication 143)